

Upcoming

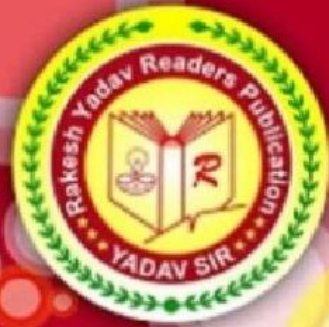

CLASS NOTES OF MATHS

- Complete Classnotes by Rakesh Yadav Sir
- Each class & Each Chapter with detailed solutions
- Method by Rakesh Yadav Sir
- Complete Arithmetic & Advanced Two in One Book.
- All the latest questions have been included to help the students know the latest pattern of the question being asked in different SSC competitive exams.

by **Rakesh Yadav**
Selected
Excise Inspector



Rakesh Yadav Readers Publication

ARITHMETIC (VOLUME-1)

S.No.	Chapter	Page No.
1.	TIME AND WORK	1-38
2.	PIPE AND CISTERN	39-54
3.	TIME AND DISTANCE	55-101
4.	BOAT AND STREAM	102-109
5.	PERCENTAGE	111-140
6.	PROFIT AND LOSS	141-167
7.	MIXTURE AND ALLEGATION	169-191
8.	RATIO AND PROPORTION	192-201
9.	PARTNERSHIP	202-208
10.	AVERAGE	209-220
11.	COMPOUND INTEREST	221-240
12.	SIMPLE INTEREST	241-254

ADVANCE MATHS (VOLUME-2)

S.No.	Chapter	Page No.
1.	NUMBER SYSTEM AND ALGEBRA	1-78
2.	HCF AND LCM	79-92
3.	GEOMETRY	93-146
4.	CO-ORDINATE GEOMETRY	147-158
5.	2D-MENSURATION	159-170
6.	3D- MENSURATION	171-209
7.	TRIGONOMETRY	211-251
8.	HEIGHT AND DISTANCE	253-262
9.	DATA INTERPRETATION	263-268

Download All Subject Free PDF

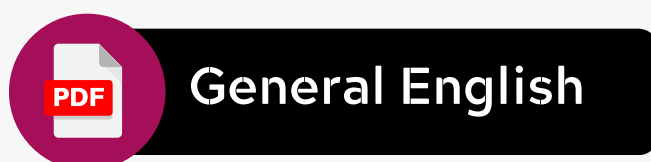
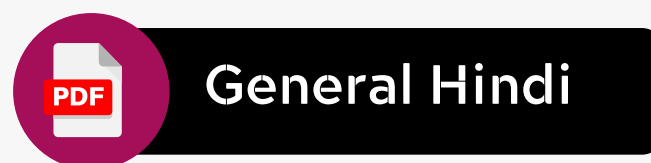
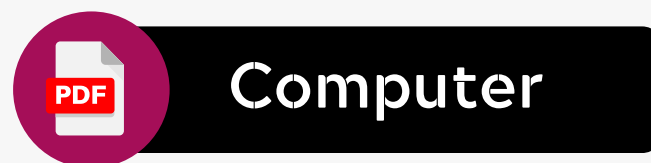
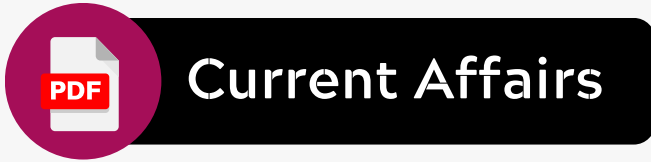
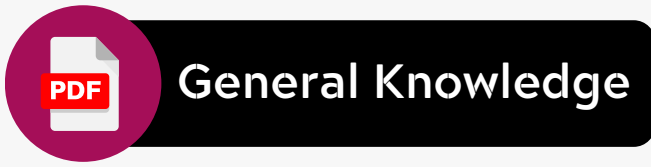



Join Our Best Course

GK Trick By
Nitin Gupta

Current Affairs

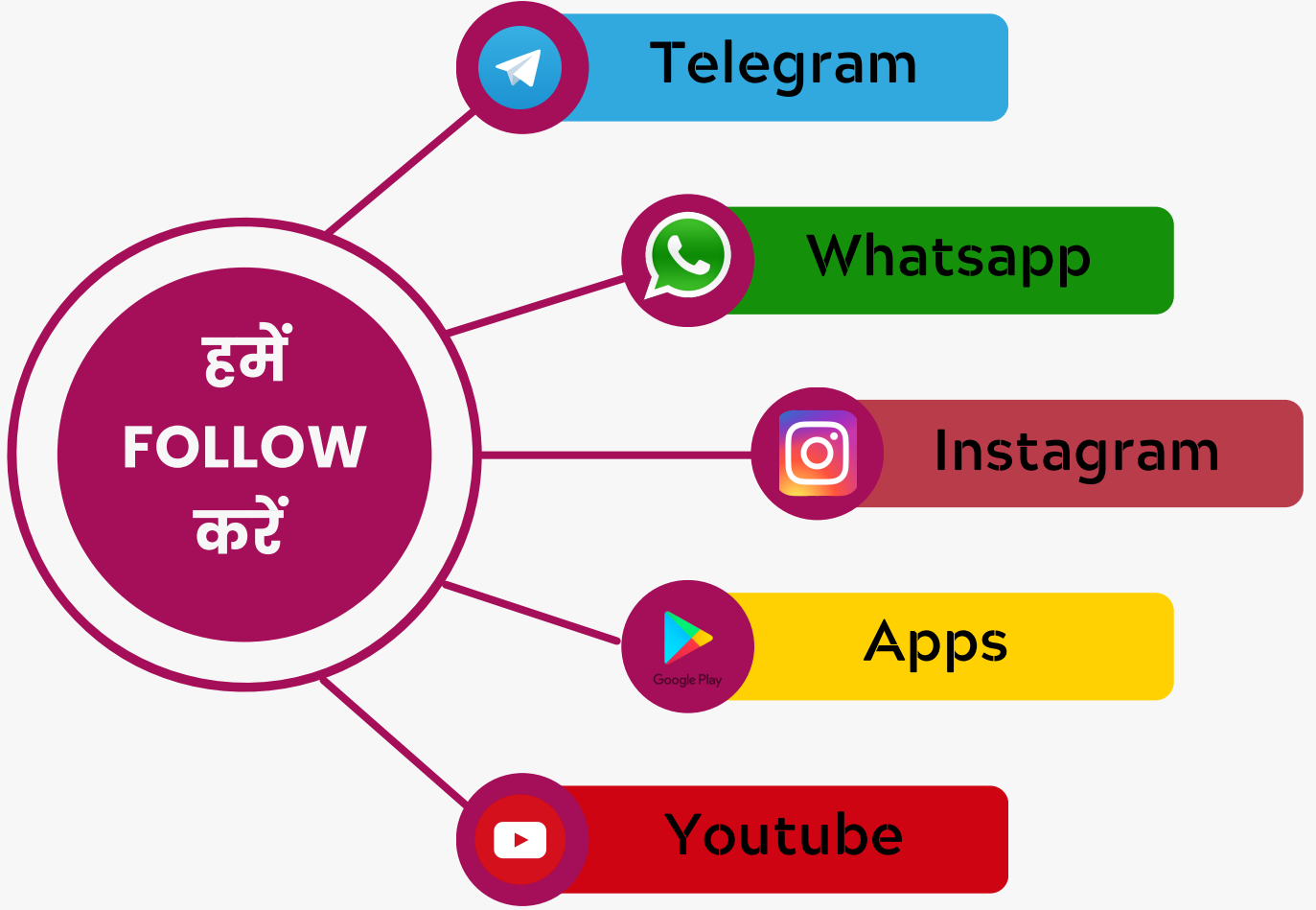
Daily Current Affairs PDF, Best Test Series, Best GK PDF के लिए हमें Follow करें



 GK Trick By Nitin Gupta
The Ultimate Key to Success.

Welcome To

GK TRICK BY NITIN GUPTA APP

यहाँ पर आपको मिलेगा

- ✓ Best PDF Notes For All Exams
- ✓ Best Test Series For All Exams
- ✓ Daily Current Affairs PDF
- ✓ सभी Course बहुत ही कम Price पर
- ✓ सभी Test Detail Discription के साथ व Analysis करने को सुविधा



Class

1.

TIME & WORK

1

- ① A & B can complete a work in 10 and 12 days respectively. A and B start working together and after 3 days, A left the work, find in how many days work will be completed?

$\begin{array}{c} \text{A} \\ 10 \text{ days} \\ +6 \\ \swarrow \\ \text{60} \\ \nwarrow \\ +5 \\ \text{B} \\ 12 \text{ days} \end{array}$	$\begin{array}{c} \text{A+B} \\ 3 \text{ days} \\ 3 \times 11 = 33 \end{array}$	$\begin{array}{c} \text{B} \\ 60 - 33 = \frac{27}{5} \\ = 5 \frac{2}{5} \text{ days} \end{array}$
--	---	---

work will be finished in = $3 + 5 \frac{2}{5} = 8 \frac{2}{5}$ days.

Q2

$\begin{array}{c} \text{A} \\ \downarrow \\ 3 \times 6 \\ = 18 \end{array}$	B
---	------------

$= 18 + \frac{42}{5} = 9 \frac{2}{5}$ days



- ② A and B started working together but after some days A left the work and the whole work will complete in 9 days. find after how many days A left. if A & B complete the work in 10 & 15 days resp.

$\begin{array}{c} \text{A} \\ 10 \text{ days} \\ +3 \\ \swarrow \\ \text{30} \\ \nwarrow \\ +2 \\ \text{B} \\ 15 \text{ days} \end{array}$	$\begin{array}{c} \text{A + B} \\ \downarrow \\ \frac{+12}{5} \\ 4 \text{ days} \end{array}$	$\begin{array}{c} \text{B} \\ \downarrow \\ 9 \times 2 = 18 \end{array}$
--	--	--

- ③ 2 men can build a wall in 15 and 20 hour resp. but if they work together they use 280 less bricks per hour and build a wall in 12 hours. find the no. of bricks in the wall.

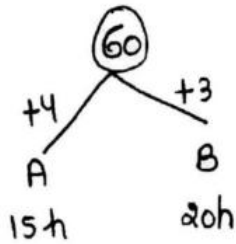

$$\left. \begin{array}{l} A+B = 7 \text{ unit} \\ A+B = 5 \text{ unit} \end{array} \right\} \begin{array}{l} -2 \text{ unit} \longrightarrow 280 \\ 1 \text{ unit} \longrightarrow 140 \end{array}$$

2-

$$A+B = \frac{60}{12} = 5 \text{ (Given)}$$

$$\begin{aligned} \text{Total bricks} &= 60 \times 140 \\ &= 8400 \text{ Bricks } \underline{\text{Ans}} \end{aligned}$$

④ 2 men can build a wall in 9 hrs and 10 hrs resp. But if they work together then they use 10 less bricks per hours and build a wall in 5 hrs. find the no. of bricks in the wall ?

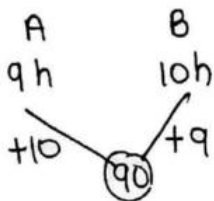

$$\left. \begin{array}{l} A+B = 19 \text{ unit} \\ A+B = 13 \text{ unit} \end{array} \right\} 1 \text{ unit} \longrightarrow 10$$

$$A+B = \frac{90}{5} = 18$$

$$\text{Total bricks} = 90 \times 10 = 900 \quad \underline{\text{Ans}}$$

⑤ Two candles of same height can burn completely in 4 hrs and 6 hrs resp. If both start burning at same time at their respective constant speed, then find after how much time ratio of their height become 2:3.

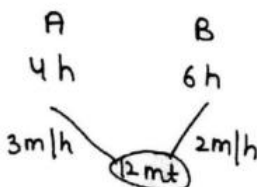

$$\frac{12-3t}{12-2t} = \frac{2}{3}$$



$$36-9t = 24-4t$$

$$5t = 12$$

$$t = \frac{12}{5} = 2 \frac{2}{5} = 2 \text{ hr, } 24 \text{ min}$$

Ans

⑥ Three men A, B, C complete the work 10, 12, 15 days.

i) if A, B and C starts work together. After 2 days A left the work and next after 2 days C also left. Then find in how many days the whole work will complete.

ii) A, B, C starts work together, A and B left the work 2 days before the completion of the work, then the whole work will finish in how many days.

iii) if A left the work 2 days before the completion of the work and B left the work 3 days before the completion. work will finish in how many days?

i)

A	B	C	$\frac{A+B+C}{2 \text{ days}}$	$\frac{B+C}{2 \text{ days}}$	B
10	12	15	\downarrow	\downarrow	$\frac{12}{5} = 2\frac{2}{5} \text{ days}$
			$15 \times 2 = 30$	$9 \times 2 = 18$	

Diagram: A circle with 60 inside. Lines connect it to 6, 5, and 4. Lines also connect 6 to 10, 5 to 12, and 4 to 15.

work will finish in = $2 + 2 + 2\frac{2}{5} = 6\frac{2}{5} \text{ days}$

OR

60	
-12	(A's 2 days)
-16	(C's 4 days)
<u>32</u>	

$\frac{32}{5} = 6\frac{2}{5} \text{ days}$ (Beoz B works for all time.)

Ans



ii)

$\frac{A+B+C}{60-8=52}$	$\frac{C}{2 \text{ days}}$
$\frac{52}{15}$	\downarrow
$= 3\frac{7}{15}$	$4 \times 2 = 8$

work will finish in = $3\frac{7}{15} + 2 = 5\frac{7}{15} \text{ days}$

OR

60	
+ 22	(A & B's 2 days work)
<u>82</u>	
$\frac{82}{15}$	

$= 5\frac{7}{15} \text{ days}$

Ans

$$\begin{array}{r}
 \text{iii)} \quad 60 \\
 + 12 \text{ (A's 2 more days work)} \\
 + 15 \text{ (C's 3 more days work)} \\
 \hline
 87 \\
 \hline
 15 = \frac{87}{5} = 5\frac{4}{5} \text{ days}
 \end{array}$$

(iv) A, B, C starts work together but A left the work after two days. and B left the work 1 day before the completion of the work. In how much time the whole work will be completed?

$$\begin{array}{r}
 60 \\
 - 12 \text{ (A's 2 days work)} \\
 \hline
 48 \quad \text{B+C} \\
 + 5 \text{ (B's 1 day work)} \\
 \hline
 53 \\
 \hline
 9 = 5\frac{8}{9} \text{ days}
 \end{array}$$

$\frac{A+B+C}{2d}$	$\frac{B+C}{26}$	$\frac{C}{4}$
↓	↓	↓
30	$\frac{26}{9}$	4
	$= 2\frac{8}{9}$	
$2 + 2\frac{8}{9} + 1 = 5\frac{8}{9} \text{ days}$		

(v) A, B and C starts work together but after 3 days A left the work, and C left the work 4 day before the completion of work. In how much time the whole work be completed?

$$\begin{array}{r}
 \times \quad \frac{A+B+C}{3d} \quad \frac{B+C}{26} \quad \frac{B}{4d} \\
 \downarrow \quad \quad \quad \downarrow \\
 45 \quad \quad \quad 26
 \end{array}$$

This method fails. & conceptually wrong becoz we can't justify that C work for 3 days.

$$\begin{array}{r}
 60 \\
 - 18 \\
 \hline
 42 \\
 + 16 \\
 \hline
 58 \\
 \hline
 9 = 6\frac{4}{9} \text{ days}
 \end{array}$$



7) A+B, B+C, C+A can complete a work in 10, 12, 20 days respectively. In how much they alone do the work.

A+B B+C C+A
10 12 20

$$2(A+B+C) = 14$$

हमें जो A+B
करके half
कर दो।

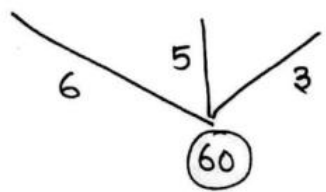

$$A+B+C = 7$$

A=2 B=4 C=1



$$A = \frac{60}{2} = 30 \text{ days}$$

$$B = \frac{60}{4} = 15 \text{ days}$$

$$C = \frac{60}{1} = 60 \text{ days}$$

Ans:

8) A+B, B+C, C+A can do a work in 20d, 30d and 40 days respectively. In how much time they alone do the work.

A+B B+C C+A
20 30 40

$$\frac{A+B+C}{6} = \frac{13}{2} = 6\frac{1}{2}$$

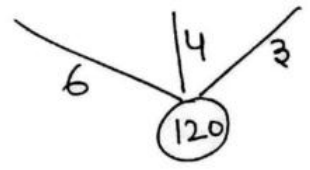

$$C = \frac{1}{2} \Rightarrow \frac{120}{1/2} = 240 \text{ days}$$

$$A = \frac{5}{2} \Rightarrow \frac{120}{5/2} = 48 \text{ days}$$

$$B = \frac{7}{2} \Rightarrow \frac{120}{7/2} = 34\frac{2}{7} \text{ days}$$

9) A+B, B+C do a work in 12 and 16 days. if A work for 5 days and B work for 7 days and C complete the remaining work in 13 days. Then find C would complete the work in how many days?

$\frac{A+B}{12d}$	$\frac{B+C}{16d}$	A 5d	B 7d	C 13d
4	3	$\frac{A+B}{5d}$	$\frac{B+C}{2d}$	$\frac{C}{11d}$
(48)		↓	↓	
		20	6	

C would complete the work = $\frac{48}{2} = 24$ day Ans.

$48 - 26 = \frac{22}{11} = 2$
↓
efficiency of C

B alone = $\frac{B+C}{\frac{1}{2}} = \frac{48}{1} = 48$ day

↓
1
→ B's efficiency

A alone = $\frac{A+B}{\frac{1}{3}} = \frac{48}{3}$ days.

↓
3
→ A's efficiency.



10) A+B can do a work in 12 days while B+C in $6\frac{2}{3}$ day work is completed by A, B, C by working 3, 4 and 7 days. find in how many days A alone would complete the whole work.

$\frac{A+B}{12d}$	$\frac{B+C}{\frac{20}{3}d}$	A 3d	B 4d	C 7d
5	9	$\frac{A+B}{3d}$	$\frac{B+C}{1d}$	$\frac{C}{6d}$
(60)		↓	↓	
		$5 \times 3 = 15$	$9 \times 1 = 9$	

$B+C = 9 \therefore \boxed{B=3}$

$A+B = 5 \therefore \boxed{A=2}$

A alone do the work = $\frac{60}{2} = 30$ days. Ans.

$\boxed{C=6}$

$60 - 24 = \frac{36}{6} = 6$ Efficiency of C

- ⑪ 3 men A, B, C complete a work in such a way that A works for all the day, B works for 1st & 2nd day and C works for 3rd, 4th and 5th day. If B+C can do as much work in 2 days as A alone does in 3 days. In how many days A, B and C alone do the work if B+C can complete the whole work without the help of A in 6 days.

$$\frac{A}{5d} \quad \frac{B}{2d} \quad \frac{C}{3d}$$

$$(B+C) \times 2 = A \times 3$$

$$\frac{A}{B+C} = \frac{2}{3} \quad (\text{Efficiency का Ratio})$$

→ B+C complete the work in 6 days and efficiency of B+C is 3

$$\text{Hence, Total work} = 6 \times 3 = 18$$

$$\frac{A}{5d} \quad \frac{B}{2d} \quad \frac{C}{3d}$$

$$\frac{A}{5d} \quad \frac{B+C}{2d} \quad \frac{C}{1d}$$

$C=2$

$$5 \times 2 = 10 \quad 2 \times 3 = 6 \quad 18 - 16 = \frac{2}{1} = 2 \rightarrow \text{efficiency of C}$$

$$B+C = 3 \quad \therefore \boxed{B=1}, \boxed{A=2}$$

$$A \text{ alone} = \frac{18}{2} = 9 \text{ days}$$

$$B \text{ alone} = \frac{18}{1} = 18 \text{ days}$$

$$C \text{ alone} = \frac{18}{2} = 9 \text{ days} \quad \underline{\underline{\text{Ans}}}$$

(35)

Eff → +7 +5

A B

Time → 5d 7d

जो Ratio Time का होगा उसके opposite ratio efficiency का होगा



⑫ A man has 3 sons. 1st one and 2nd one can complete a work in 24 days and 36 days respectively. In how many days the 3rd son will complete the work, if the man could alone complete the whole work in $3\frac{3}{11}$ days. The man can do double the work in same time. In what time all his sons together can complete the work.

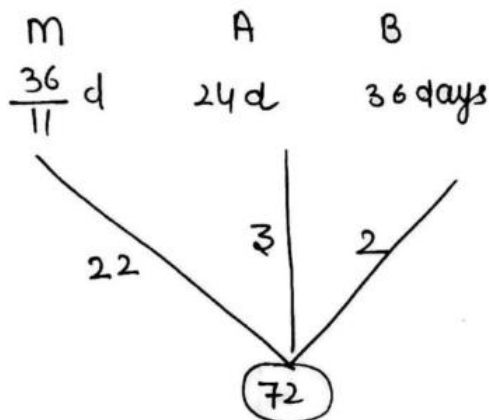

	M	:	(A+B+C)
T →	1	:	2
Eff →	2	:	1
	↓		↓
	22		11
l →	11		

$$A + B + C = 11$$

$$\downarrow \quad \downarrow$$

$$3 \quad 2$$

$C = 6$

C complete the work

$$= \frac{72}{6} = \underline{\underline{12 \text{ days}}}$$



Class
2.

By  Chhoker
72

9

- (13) $1m + 3w + 4c$ does a work in 96 hours while $2m + 8c$ can complete the same work in 80 hrs. and $2m + 3w$ can complete the same work in 120 hrs. find in how much time will 10 men + 5 women complete the work.

$$\begin{array}{ccc} \overbrace{1m + 4c + 3w}^3 & \underbrace{2m + 8c} & \underbrace{2m + 3w} \\ 96 \text{ Hr} & 80 \text{ Hr} & 120 \text{ Hr} \end{array}$$

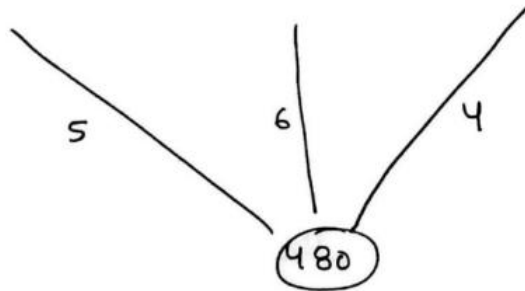

$$\begin{aligned} 2m + 8c &= 6 \\ \therefore 1m + 4c &= 3 \end{aligned}$$

$$1m + 4c + 3w = 5$$

$$3w = 2$$

$$w = \frac{2}{3}$$

$$2m + 3w = 4$$

$$2m = 2$$

$$m = 1$$

$$10m + 5w$$

$$10 + 5 \times \frac{2}{3} = \frac{40}{3}$$

$$10m + 5w \text{ complete the work} = \frac{480}{\frac{40}{3}} = \frac{480 \times 3}{40} = 36 \text{ Hrs.}$$

- (14) A, B, C can complete a work in 30 days by working together. A + C are twice efficient than B and A + B are thrice efficient than C. find in how many days A alone complete the work.

दोनों जगह A, B, C हैं, so दोनों 10 जगह (A+B+C) को efficiency same ऐसी चाहिए.

$$\frac{A+C}{B} = \frac{2}{1} \Rightarrow \frac{8}{4}$$

$$\frac{A+B}{C} = \frac{3}{1} \Rightarrow \frac{9}{3}$$

B	C	A
4	3	5

Total work = $12 \times 30 = 360$ units

A alone = $\frac{360}{5} = 72$ days. Ans

(15) A+B can complete a work in half the time of C, while B+C can complete the same work in 1/3rd time than A. If they together complete the work in 20 days. In how many days they alone do the work.

$$\frac{A+B}{C} = \frac{\text{Time}}{1} = \frac{\text{Eff.}}{2} = \frac{8}{4}$$

$$\frac{B+C}{A} = \frac{1}{3} = \frac{3}{1} = \frac{9}{3}$$

C	:	B	:	A
4		5		3

Total work = $12 \times 20 = 240$ unit

A alone = $\frac{240}{3} = 80$ days

B alone = $\frac{240}{5} = 48$ days.

C alone = $\frac{240}{4} = 60$ days



(16) A+B can complete a work in 40% lesser time than C while B+C can complete the same work in 60% lesser time than A, if they together can complete the whole work in 20 days, then in how many days will they alone complete the same work.

$$\frac{A+B}{C} = \frac{\text{Time}}{\frac{60-3}{100-5}} = \frac{\text{Eff.}}{3} = \frac{35}{21}$$

$$\frac{B+C}{A} = \frac{40-2}{100-5} = \frac{5}{2} = \frac{40}{16}$$

$$A : B : C \\ 16 : 19 : 21$$

Total work = $56 \times 20 = 1120$ unit

A alone = $\frac{1120}{16} = 70$ days Ans



(17) A takes as much time as B+C take to finish a job, A+B finish the job in 10 days, C can alone do the same job in 15 days. In how many days B alone can do the work.

A	:	B+C							
Time -	1	:	1						
Eff -	1	:	1						
	↓		↓						
	$2\frac{1}{2}$		$2\frac{1}{2}$						
			<table style="margin-left: 20px;"> <tr> <td>B</td> <td>:</td> <td>C</td> </tr> <tr> <td>$\frac{1}{2}$</td> <td>:</td> <td>2</td> </tr> </table>	B	:	C	$\frac{1}{2}$:	2
B	:	C							
$\frac{1}{2}$:	2							

30

+2 +3

C A+B

15d 10d

Eff. (A+B+C) = 5

B alone = $\frac{30}{\frac{1}{2}} = 60$ days Ans



(18) A complete half as much work as B in equal time. C complete half as much work as A & B together in equal time. If C alone can complete the work in 40 days. Then in how many days they all together complete the work.

	A	:	B		C
Time	1	:	2		
Eff.	1	:	2	:	$\frac{3}{2}$
	2	:	4	:	3

Total work = 3×40
= 120

12



All together = $\frac{120}{9}$ days.

19) In a factory there are 3 shifts of work for a day. During the 3 shift the avg. working efficiency of workers is 80%, 70% and 50% respectively. A work is complete in 60 days by the group working in the 1st shift. If the work is done in all the shift then how many days less are required to complete the work.

	I	II	III
E →	80	: 70	: 50
	8	: 7	: 5

Total work = $8 \times 60 = 480$

if work in all shifts work will complete in $\frac{480}{20} = 24$ day.

less days = $60 - 24 = 36$ days Ans

20) Two workers A & B working together can complete a job in 5 days. if A work twice as efficiently as he actually did and B work $\frac{1}{3}$ efficiently as he actually did, then the work would have been completed in 3 days. A alone can complete the work in how many days.

$$(A+B) \times 5 = \left(2A + \frac{B}{3}\right) \times 3$$

$$5A + 5B = 6A + B$$

$$A = 4B$$

$$\frac{A}{B} = \frac{4}{1}$$

Eff. (A+B) = 5 & they complete the work in 5 days

∴ Total work = $5 \times 5 = 25$ unit

A alone = $\frac{25}{4} = 6\frac{1}{4}$ days.

(21) A+B can complete a work in 8 days but if A & B work twice & $\frac{1}{3}$ of their respective efficiency, then the work is completed in 6 days. In how many days A alone can complete the work?

$$(A+B) \times 8 = \left(2A + \frac{B}{3}\right) \times 6$$

$$8A + 8B = 12A + 2B$$

$$4A = 6B$$

$$\frac{A}{B} = \frac{6}{4} = \frac{3}{2}$$



$$\text{Total work} = (3+2) \times 8 = 40 \text{ unit}$$

$$A \text{ alone} = \frac{40}{3} \text{ days}$$

(22) A started a work and left working 4 days. B finished the remaining work in next 18 days. Had A left the work after working for 6 days then B would have finished the remaining work in next 12 days. Then find in how many days A & B alone can complete the work.

$$+2 \left(\begin{array}{cc} A & B \\ 4 \text{ day} & 18 \text{ day} \\ 6 \text{ day} & 12 \text{ day} \end{array} \right) - 6$$

$$A \times 2 = B \times 6^3$$

$$\frac{A}{B} = \frac{3}{1}$$



$$\begin{aligned} \text{Total work} &= A && B \\ &= 4 \times 3 &+& 18 \times 1 \\ &= 12 &+& 18 \\ &= 30 \end{aligned}$$

$$A \text{ alone} = \frac{30}{3} = 10 \text{ days}$$

$$B \text{ alone} = \frac{30}{1} = 30 \text{ days}$$

23) P, Q, R are 3 typists working simultaneously can type 216 pages in 4 hrs. In one Hr R can type as many pages more than Q as Q can type more than P. R can type as many pages in 5 hrs as P in 7 hrs. How many pages does each of them type per hour.

$$R \times 5 = P \times 7$$

$$\frac{R}{P} = \frac{7}{5}$$

P	Q	R	
5x	6x	7x	$\frac{5+7}{2} = 6$

$$18x \times 4 = 216$$

$$x = 3$$

$$P = 5 \times 3 = 15 \text{ page/hour}$$

$$Q = 6 \times 3 = 18 \text{ page/hour}$$

$$R = 7 \times 3 = 21 \text{ page/hour}$$

24) Three typist working together 8 hrs per day can type 900 pages in 20 days. The no. of pages typed by A in 4 hrs equal to the no. of pages typed by C in 1 Hr. How many page typed by C in 1 Hr if in a day B type as many pages more than A as C types as many pages more than B.

$$A \times 4 = C \times 1$$

$$\frac{A}{C} = \frac{1}{4}$$

A	B	C	
1x	2.5x	4x	$\frac{1+4}{2} = 2.5$

$$\frac{5}{7.5} x \times \frac{4}{8} \times 20 = \frac{453}{900}$$

$$x = \frac{3}{4}$$

$$C = 4 \times \frac{3}{4} = 3 \text{ Page/Hr.} \quad \underline{\underline{\text{Ans.}}}$$

(25) A+B can complete a work in 30 days. They start work together and after 23 days B left the work and whole work complete in 33 days. Find the time in w/c A alone can complete the work.

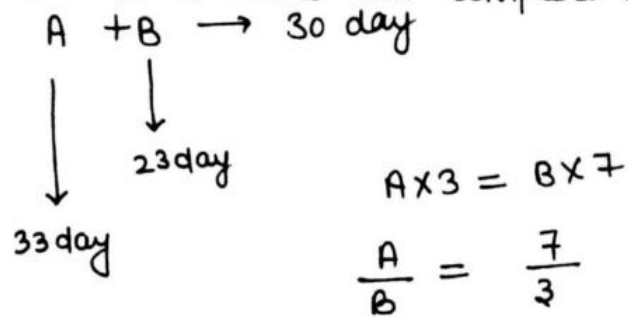

Total work = $(7+3) \times 30 = 300$ unit

A alone = $\frac{300}{7}$ days

B alone = $\frac{300}{3} = 100$ days.



(26) A+B can complete a work in 24 days. In how many days A alone does the $\frac{2}{3}$ of the total work if they start working together after 20 days A left the work, work is completed in 26 days.

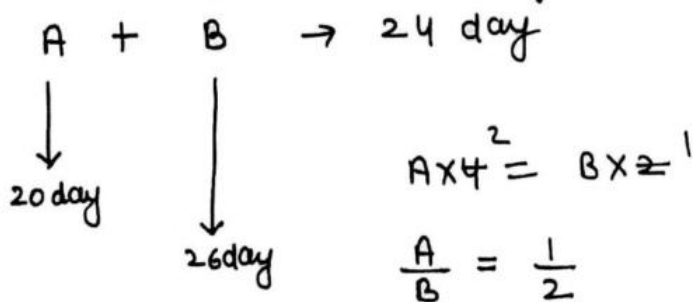

Total work = $(1+2) \times 24 = 72$ unit

$\frac{2}{3}$ of total work = $72 \times \frac{2}{3} = 48$ unit

$\frac{2}{3}$ of work completed by A alone = $\frac{48}{1} = 48$ days

Ans

(27) A & B can complete a work in 12 days. A alone works for 16 days & B completes the remaining work in 20 days by doing alone. In how much time B alone does the complete work.

$$\begin{array}{ccc} A + B & \rightarrow & 12 \text{ days} \\ \downarrow & & \downarrow \\ 8d & & 20d \end{array} \quad A \times 4 = B \times 8$$
$$\frac{A}{B} = \frac{2}{1}$$

Total work = $3 \times 12 = 36$ unit

A alone = $\frac{36}{2} = 18$ days

B alone = $\frac{36}{1} = 36$ days.



(28) P & R complete a work in 10 days doing together. If P works for 2.5 days and R for 8.5 days, they finish half work. In how much time P alone complete the work.

$$\begin{array}{ccc} P + R & \rightarrow & 10 \text{ days} \\ \downarrow & & \downarrow \\ 2.5d & & 8.5d \end{array} \quad P \times 2.5 = R \times 8.5$$
$$\frac{P}{R} = \frac{7}{5}$$

(They complete half work in 5 days)

Total work = $(7+5) \times 10 = 120$ unit

P alone = $\frac{120}{7}$ days.

(29) A alone would take 27 Hrs more to complete a work than A & B work together. B takes 3 Hrs more to complete a work alone than A & B work together. In how many days A alone can do it.

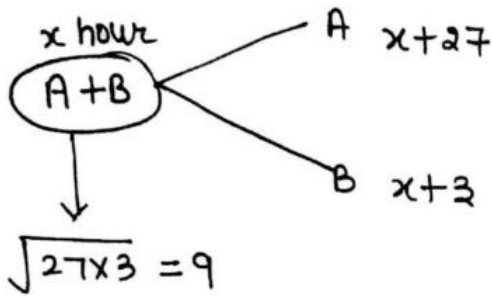

$x = 9 \text{ Hrs}$

A alone = $9+27 = 36 \text{ Hrs}$

B alone = $9+3 = 12 \text{ Hrs}$

30) A and B alone complete a work in 12 days and 3 days more days respectively than A+B, then find in how many days A alone does the work.

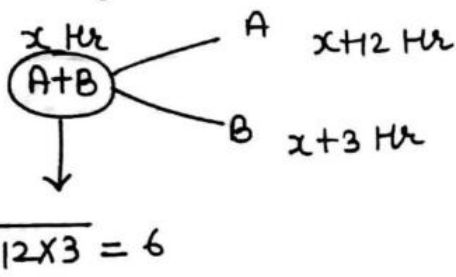

$x = 6 \text{ Hrs}$

A alone = $6+12 = 18 \text{ Hrs}$

B alone = $6+3 = 9 \text{ Hrs}$



31) A can complete a work in 5 more days than B while A does the same work in 9 more days than C. if A+B can complete the whole work in same time in w/c C alone does the whole work. In how many days A alone could complete the same work.

A B C
 (x+9) (x+4) x day

A	B	C
95	90	86
↓	↓	↓
x+9	x+4	x

$$A+B = C$$

$x \text{ day}$
 $x \text{ day}$

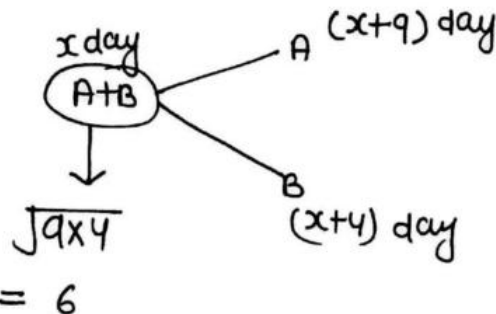

$$x = 6 \text{ day}$$

$$A = 6 + 9 = 15 \text{ day}$$

$$B = 6 + 4 = 10 \text{ day}$$

$$C = 6 \text{ day}$$



(32) A swimming pool is fitted with 3 pipes, the 1st two pipes working simultaneously fill the pool in the same time as the 3rd pipe alone, the 2nd pipe alone fills the pool 5 hrs faster than the 1st pipe & 4 hrs slower than 3rd pipe. In what time 2nd & 3rd pipe together fill the pool.

A	B	C
$x+9$	$x+4$	x



A	B	C
100	95	91
↓	↓	↓
$x+9$	$x+4$	x

$$A+B = C$$

x
 x

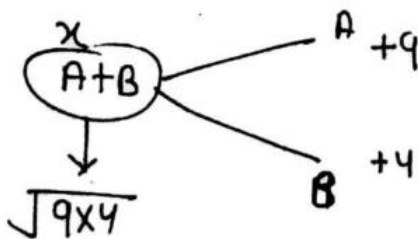

$$A = 15 \text{ Hrs}$$

$$B = 6 + 4 = 10 \text{ Hrs}$$

$$C = 6 \text{ Hrs}$$

Ans

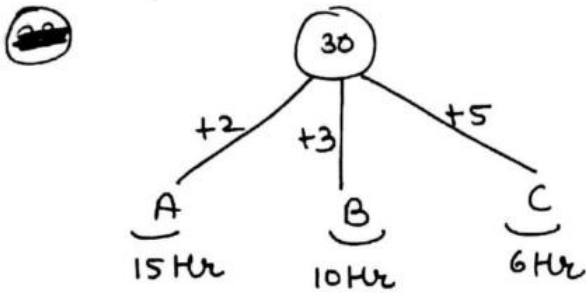

$$B+C = \frac{30}{8} \text{ Hrs.}$$

Class

3.

By  hroker
7228446674

(33) 3 men A, B and C working together can do a job 6 hrs less time than A alone did, 1 hr less time than B alone and half the time needed by C. In how many days will A finish the work alone?

A+B+C	A	B	C
x hr	x+6	x+1	2x

A+B+C	C
-------	---

T 1 : 2

Eff. 2 : 1

$C=1$

$$\frac{A+B+C}{1} = \frac{2}{1}$$

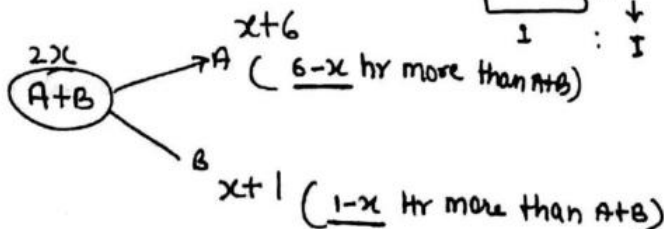

$$\begin{aligned} &\Rightarrow x+6-2x \\ &\quad \underline{6-2x} \\ &\Rightarrow x+1-2x \\ &\quad \underline{1-2x} \end{aligned}$$

$$A+B = \sqrt{(6-x)(1-x)} = 2x$$

$$(6-x)(1-x) = 4x^2$$

$$4x^2 = 6 - 7x + x^2$$

$$3x^2 + 7x - 6 = 0$$

$$\begin{array}{c} +9 \quad -2 \\ \hline \end{array}$$

$$3x^2 + 9x - 2x - 6 = 0$$

$$3x(x+3) - 2(x+3) = 0$$

$$(3x-2)(x+3) = 0$$

$$3x = 2$$

$$x = \frac{2}{3}$$

$$x = -3$$

$$x$$

A will finish the work = $\frac{2}{3} + 6 = \frac{20}{3}$ days. Ans.

(OR)

A	B	C
$x+6$	$x+1$	$2x$

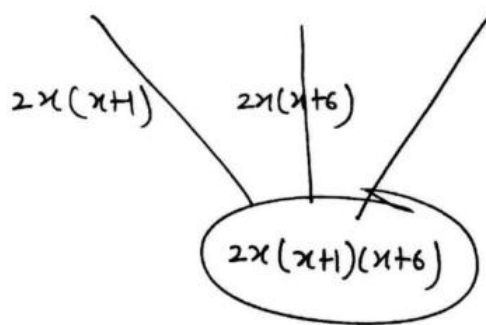

$$\frac{2x(x+6)(x+1)}{2x^2 + 2x + 2x^2 + 12x} = \frac{2x}{1}$$

$$x^2 + x + 6x + 6 = 4x^2 + 14x$$

$$x^2 + 7x + 6 = 4x^2 + 14x$$

$$3x^2 + 7x - 6 = 0 \quad (\text{same eqn as above})$$

(34) 3m and 4w can complete a work in 16 days while 4m and 3w can complete the same work in 12 days. Then find 7m & 7w can complete the same work in how many days.

$$(3m + 4w) \times 16 = (4m + 3w) \times 12$$

$$48m + 64w = 48m + 36w$$

$$28w = 0$$

$$w = 0$$

$$(3m + 0) \times 16 = (4m + 0) \times 12$$

$$T \cdot W = 16 \times 3 = 48$$

$$7m + 7w = 7 + 0 = 7$$

$$\text{Hence } 7m + 7w = \frac{48}{7} \text{ days.}$$



35) A, B, & C can complete a work in 10, 12 and 15 days respectively. If they start work together till the whole work complete, find the share of wages of A, B & C out of the total wages of Rs 750.

A	B	C
10	12	15

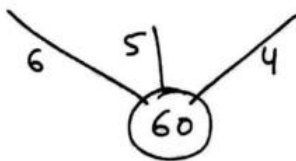

$$\frac{60}{15} = 4d$$

$$15 \rightarrow 750$$

$$1 \text{ unit} \rightarrow 50$$

A	B	C
$6 \times 4d$	$5 \times 4d$	$4 \times 4d$

$$6 : 5 : 4$$

$$A = 6 \times 50 = 300 \text{ Rs}$$

$$B = 5 \times 50 = 250 \text{ Rs}$$

$$C = 4 \times 50 = 200 \text{ Rs.}$$

wages are distributed in the ratio of the work

अगर सारे मिलकर खत्म होने तक काम करते रहे तो उनके काम का ratio और efficiency का ratio same होता है।

36) B+C can complete a work in 50% more time than $\frac{2}{3}$ A+B+C. If they work together on a job till the whole work completes then B earns 120 out of total earning of Rs 450. Then find in how many days they together complete the whole work while A+B takes $\frac{8}{3}$ more no. of days to complete the work than A+B+C.

$$\frac{B}{A+B+C} = \frac{120}{450}$$

$$\frac{B}{A+B+C} = \frac{120}{450}$$

$$\frac{B+C}{A+B+C} = \frac{2 \times 5}{3 \times 5} = \frac{10}{15}$$



B+C	A+B+C
T 150-3	100-2
E 2	: 3

A	B	C
E 5	: 4	: 6

A+B	A+B+C
E 9	: 15

Time \rightarrow $5x$: $3x$

$$A+B+C = 3x \text{ days} = 3 \times \frac{4}{3} = 4 \text{ days} \text{ Ans}$$

$$2x = \frac{8}{3}$$

$$x = \frac{4}{3}$$

37) A & B complete a work in 12 and 15 days. They started the work alternatively for 1 day each & A started the work first. In how much time 60% of work will be completed.

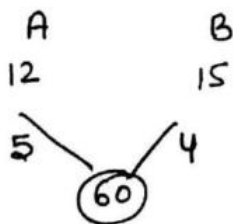

$$60\% \text{ of work} = \frac{60 \times 60}{100} = 36$$

$$1 \text{ cycle (2 days)} = 5 + 4 = 9$$

$$\times 4$$

8 days

$$\downarrow \times 4$$

36

Ans

38) 3 men A, B, C can make 12,000 pens in 2 hrs, 4 hrs & 3 hrs respectively, if they work half hr every time, but they do not work together and A starts the work first. find in how much time they can make 18500 pens.

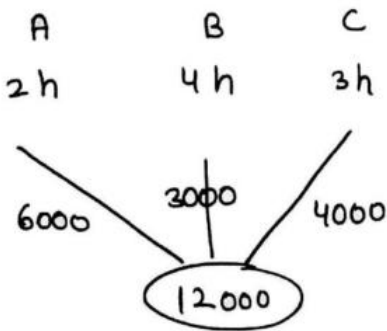

$\frac{1}{2}$ A	$\frac{1}{2}$ B	$\frac{1}{2}$ C
3000	1500	2000
1 cycle ($\frac{3}{2}$ hrs) \rightarrow 6500 pens		
1×2 \rightarrow 1×2		
3 hrs \rightarrow 13000		
$\frac{1}{2}$ hr \rightarrow 3000		
$\frac{1}{2}$ hr \rightarrow 1500		
$\frac{15 \text{ min}}$ \rightarrow 1000		
<u>4 hr 15 min</u> <u>Ans</u> <u>18500</u>		

39) A & B complete a work in 24 & 30 days respectively, working 10 hrs per day the work is to be done in 2 shifts. morning shift is for 6 hrs and evening is for 4 hrs. On the 1st day A works in morning and B works in evening & they interchange their shifts everyday, find in how much time and on w/c day the work will be completed.

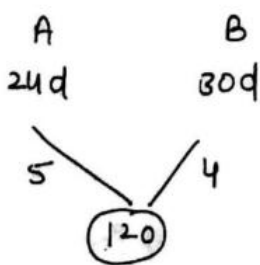

	1st 6 hrs	2nd 4 hrs
1st day	A (6)	B (4)
2nd day	B (6)	A (4)
1 cycle (2 day) \rightarrow 9 (5+4)		

$$\begin{array}{r}
 1 \text{ cycle (2 d)} \quad \text{---} \quad 9 \\
 | \times 13 \\
 \hline
 26 \text{ d} \quad \text{---} \quad 117 \\
 \\
 A - 6 \text{ Hr} \quad \text{---} \quad 3 \\
 \hline
 26 \text{ d } 6 \text{ Hr} \quad \text{Ans} \quad \frac{3}{120}
 \end{array}$$

$$A = \frac{4}{10} \times 63 = 3$$

$$\begin{array}{l}
 A = 5 \text{ in } 10 \text{ Hrs} \\
 \text{in } 1 \text{ Hr} \quad \frac{5}{10} = \frac{1}{2} \\
 \text{in } 6 \text{ Hr} \quad \frac{1}{2} \times 6 = 3
 \end{array}$$

work will finish on 27th day.

40) A, B, C have to supply an order of 100 pens. A, B, C make a pen in 2, 3, 4 hrs respectively. In how many days they will complete the work if each one make a complete pen himself without the help of others.

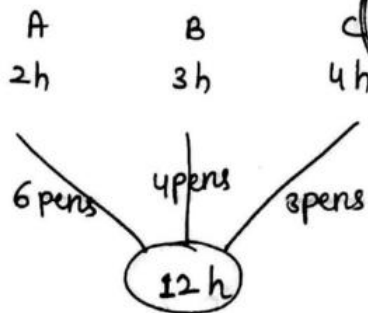

$$12 \text{ h} \longrightarrow 13 \text{ pens}$$

$$| \times 7$$

$$84 \text{ Hrs} \longrightarrow 91 \text{ pens}$$

$$9 \text{ hrs} \longrightarrow 9 \text{ pen}$$

$$\begin{array}{r}
 93 \text{ Hrs} \quad \text{Ans} \\
 \hline
 100 \text{ pen}
 \end{array}$$

$$\begin{array}{r}
 A \quad B \quad C \\
 2 \text{ h} \quad 3 \text{ h} \quad 4 \text{ h}
 \end{array}$$

$$8 \text{ h} \rightarrow 4 \text{ pen } 2 \text{ pen } 2 \text{ pen } (= 8 \text{ pen}) \times$$

$$9 \text{ h} \rightarrow 4 \text{ pen } 3 \text{ pen } 2 \text{ pen } (= 9 \text{ pen}) \checkmark$$

41) A, B, C finished a work in 10 days. Initially they started work together but C works only for 3 day, & in these 3 days 37% of the work had been completed and Rest of the work is done by A & B. Find in how many days they individually complete the work if A's 5 days work = B's 4 days work.

$$A + B + C \xrightarrow{3d} 37$$

Total work = 100 25

$$A + B \xrightarrow{7d} 63$$

$$(A+B)1d = \frac{63}{7} = 9$$

$$(A+B)3d = 9 \times 3 = 27$$

$$\begin{array}{r} A + B + C \xrightarrow{3d} 37 \\ \hline 27 \quad \downarrow \\ \quad \quad 10 \end{array}$$

$$(C)1d = \frac{10}{3}$$

C will do complete work

$$= \frac{100 \times 3}{10} = 30 \text{ days}$$

$$A \times 5 = B \times 4$$

$$\frac{A}{B} = \frac{4}{5} \Rightarrow 9$$

$$\boxed{A = 4}$$

$$\boxed{B = 5}$$

$$\begin{array}{c} 9 \\ \swarrow \quad \searrow \\ 4 : 5 \\ A \quad B \\ 4 \quad 5 \end{array}$$

$$A = \frac{100}{4} = 25 \text{ days}$$

$$B = \frac{100}{5} = 20 \text{ days}$$

Ans

42) 40 men can complete a work in 30 days. They start work together and after every 10 days 5 men left the work. In how much time work will be completed?

$$40 \text{ men} \times 30 \text{ day} = 1200$$

$$40 \text{ men} \times 10 \text{ day} = 400$$

$$35 \text{ men} \times 10 \text{ day} = 350$$

$$30 \text{ men} \times 10 \text{ day} = \frac{300}{1050}$$

$$25 \text{ men} \times \underline{6 \text{ day}} = \frac{150}{1200}$$

36 days.



1 men = 1 Rs
40 " = 40 Rs.

CLASS
4

By Pardeep Chhoker
7206446517

28

(43) 60 men can complete a work in 40 days. They start work together but after every 10 day, 5 men leave the work. In how time the work will be completed?

- 60 men x 40 day = 2400

60 men x 10 day = 600

55 men x 10 day = 550

50 men x 10 day = 500

45 men x 10 day = 450

40 men x $7\frac{1}{2}$ day = 2100

$\frac{300}{40} = 7\frac{1}{2} d$

Total days = $40 + 7\frac{1}{2} = 47\frac{1}{2}$ days.



(44) 33 men can do a job in 30 days. If 44 men started the work together & after every day 1 person leave the work. then what is the minimum no. of days required to complete the whole work.

- 33 men x 30 day = 990

maximum 44

दिन काम हो सक्त!

$44 + 43 + 42 \dots \dots \dots$

$\frac{n}{2} [2a + (n-1)d]$

$\frac{n}{2} [88 + (n-1)(-1)] = 990$

$\frac{n}{2} [89 - n] = 990.$

put value of n from options .

or assume yourself .

$$n = 44$$

$$\frac{44}{2} [89 - 44] \Rightarrow 22 \times 45 = 990 .$$

\therefore min. no. of days to finish the work = 44 days.

(45) A group of men decided to do a job in 4 days but 20 men dropped out everyday, the job was completed at the end of 7th day. find the men who are in the work initially ?

$$\text{Total work} = m \times 4 = 4m$$

$$m + (m-20) + \dots$$

$$\frac{7}{2} [2m + 6(-20)] = 4m$$

$$\frac{7}{2} [2m - 120] = 4m$$

$$7m - 420 = 4m$$

$$3m = 420 \quad 140$$

$$\boxed{m = 140}$$



(46) 3 cooks have to make 80 burgers. They are known to make 20 pcs every minute by working together. The 1st cook began working alone and made 20 pcs having worked for sometime more than 3 min and rest work completed by 2nd & 3rd cook and it takes a total of 8 min to complete the whole work. In how much time the 1st will make 160 burgers.

A → (3+x) min — 20 burger

$$A(\text{eff}) = \frac{20}{3+x}$$

(B+C) → (5-x) min — 60 burger

$$B+C(\text{eff}) = \frac{60}{5-x}$$

$$\Rightarrow \frac{20}{3+x} + \frac{60}{5-x} = 20$$

Assume values of x.

$$x = 1$$

satisfies the equation

$$A(\text{eff}) = \frac{20}{3+1} = 5 \text{ burger/min}$$

$$A \rightarrow 160 \text{ burger} \rightarrow \frac{160}{5} = 32 \text{ min} \quad \underline{\text{Ans.}}$$



(47) A+B can complete a work in 6 days. In how many days they ^{alone} do the same work if A+C can complete the same work in 2½ days lesser than B+C. They together complete the work in 5 days.

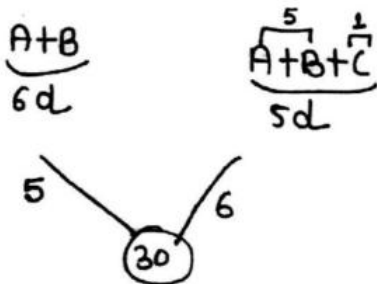

$$A+B(\text{eff}) = 5$$

$$C(\text{eff}) = 1$$

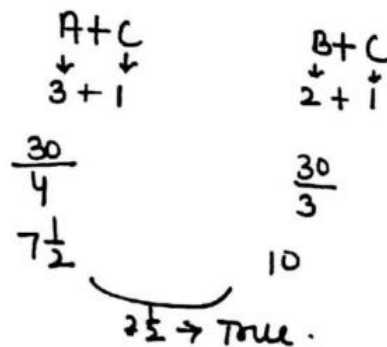

Hence

$$A = 3$$

$$B = 2$$

$$C = 1$$

C is same in both place.
Hence A+B.
Assume value.
A+B=5
A B
3 2
4 1

C alone = $\frac{30}{1} = 30$ days

B alone = $\frac{30}{2} = 15$ days

A alone = $\frac{30}{3} = 10$ days.

(48) Four men can do a piece of work in 6 days while 3 women can complete the same work in 16 days. In how many days 1 man + 2 women can complete the work.

$$4m \times 6 = 3w \times 16$$

$$m = 2w$$

$$\frac{m}{w} = \frac{2}{1}$$

Total work = $4 \times 2 \times 6 = 48$ unit



$$\begin{array}{ccc} 1m + 2w & & \\ \downarrow & \downarrow & \\ 2 \times 1 & 2 \times 1 & = 4 \end{array}$$

(1m + 2w) complete the work = $\frac{48}{4} = 12$ days.

(49) 2 men can complete a work in 3 days, while 3 women can complete the same work in 4 days & 4 children can complete the same work in 6 days. In how many days 1 man + 2 children can complete the same work.

$$2m \times 3 = 3w \times 4 = 4c \times 6$$

$$1m = 2w = 4c$$

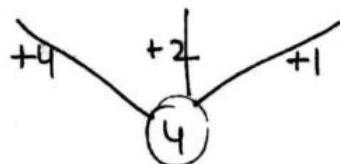

$$\text{total work} = 2m \times 3 = 2 \times 4 \times 3 = 24 \text{ unit}$$

$$1m + 2c = 4 + 2 = 6$$

$$(1m + 2c) \text{ complete the work} = \frac{24}{6} = 4 \text{ days } \underline{\text{Ans}}$$

(50) 6 men + 8 women complete a work in 10 days while 26 men + 48 women in 2 days. In how many days 7 men + 3 women will complete the work?

$$(6m + 8w) \times 10 = (26m + 48w) \times 2$$

$$30m + 40w = 26m + 48w$$

$$4m = 8w$$

$$\frac{m}{w} = \frac{2}{1}$$

$$T \cdot W = (6 \times 2 + 8 \times 1) \times 10 = 20 \times 10 = 200 \text{ unit}$$

$$(7m + 3w) = 7 \times 2 + 3 \times 1 = 17$$

$$(7m + 3w) \text{ complete the work in} = \frac{200}{17} = 11 \frac{13}{17} \text{ days.}$$

(51) 12 men + 18 women can complete a work in 10 days while 3 men + 18 women can complete the same work in 12 days. In how many days 2 men + 3 women will complete the work?

$$(12m + 18w) \times 10 = (3m + 18w) \times 12$$

$$60m + 90w = 18m + 108w$$

$$42m = 18w$$

$$\frac{m}{w} = \frac{3}{7}$$

$$T \cdot W =$$

$$(12 \times 3 + 18 \times 7) \times 10$$

$$1620 \text{ unit}$$

$$2m + 3w = 2 \times 3 + 3 \times 7 = 27$$

$$(2m + 3w) \text{ will finish the work} = \frac{60}{27} = 60 \text{ days}$$

(52) 2 men can complete a piece of work in 3 days while 3w can complete the same work in 4 days and 4 children can complete the same work in 6 days. Then find in how many days 1 men + 1 women + 2 children can complete the same work.

$$2m \times 3 = 3w \times 4 = 4c \times 6$$

$$1m = 2w = 4c$$

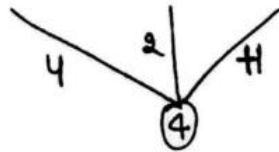

$$\text{Total work} = (2 \times 4) \times 3 = 24$$

$$(1m + 1w + 2c) = 4 + 2 + 2 = 8$$

$$(1m + 1w + 2c) \text{ complete the work} = \frac{24}{8} = 3 \text{ days } \underline{\underline{\text{Ans.}}}$$

(53) There is sufficient food for 400 soldiers for 30 days. After 28 days 280 soldiers left the camp. for how many days will the rest of the food last for the rest of the soldiers.

$$400 \times 30 = 120 \times D$$

$$D = 10 \text{ days}$$

(54) There is sufficient food for 1600 soldiers for 50 32 days and each person ~~is~~ eat 900 gm food everyday.

After 40 days, 400 soldiers left the camp. Now for how many days will the rest of the food lasted for the rest of the soldiers if each soldier ate 1000 gm food everyday.

$$1600 \times 900 \times 50 = 1200 \times 1000 \times D$$

$$D = 12 \text{ days } \underline{\text{Ans.}}$$

(55) There are sufficient food for certain no. of soldiers for certain no. of days. After 20 days $\frac{1}{4}$ th soldier left the camp and the rest of the food will last for the same no. of days that are in starting. find the no. of days in the starting.

$$S \times (D-20) = \frac{3}{4} S \times D$$

$$D-20 = \frac{3D}{4}$$

$$4D-80 = 3D$$

$$D = 80 \text{ days } \underline{\text{Ans.}}$$



(56) A complete $\frac{7}{10}$ of a work in 15 days, then he completes the remaining work with the help of B in 4 days. find in how much time (A+B) can complete the whole work.

A — $\frac{7}{10} \rightarrow 15$ days

(A+B) — $\frac{3}{10}$ work = 4 days

(A+B) — complete work = $4 \times \frac{10}{3} = \frac{40}{3}$ days.

57) A team of 30 men is supposed to do a work in 38 days.

After 25 days, 5 more men were employed on work due to w/c the work is completed 1 day earlier. How many days would it have been delay if 5 more men were not employed.

30 men x 38 day

30 men x 25d = 750

35 men x 12d = 420

1170

~~1170~~ = 39 days

~~30~~

1 day would delay.

OR

5 men x 12d = 60

अगर 5 men ना आते तो ये 60 काम 30 men करते

~~60~~ = 2 दिन में

$\frac{37}{+2}$
39 days

1 day would delay.



58) A contractor undertook to finish a road in 40 days & he employ 100 men. After 35 days he employed 100 more men, the work finished on time. Then find if more men were not employed then work will complete how much late?

$$100 \text{ m} \times 35 \text{ d} = 3500$$

$$200 \text{ m} \times 5 \text{ d} = \frac{1000}{}$$

$$T \cdot W = 4500$$

अगर इसको 100 men ही करते $\frac{4500}{100} = 45 \text{ days}$

5 days would delay.

(OR)

$$100 \text{ men} \times 5 \text{ d} = 500$$

अगर 100 नहीं आते तो इस 500 को पुराने वाले 100 कर रहे होते.

$$\frac{500}{100} = 5 \text{ days delay.}$$

(59) 5 m can prepare 10 toys in 6 days working 6 Hrs per day.

In how many days can 12 m

prepare 16 toys working 8 Hrs per day.

$$\frac{5 \times 6 \times 6}{10} = \frac{12 \times 8 \times D}{16}$$

$$D = 3 \text{ days} \quad \underline{\text{Ans.}}$$

$$\frac{m_1 h_1 d_1}{w_1} = \frac{m_2 d_2 h_2}{w_2}$$



(60) A contractor undertook to dig a canal of 12 km long in 350 days & employed 45 men. After 200 days only 4.5 km work was completed. How many more men should he employ to complete the whole work on time.

$$\frac{15 \times 45 \times 200}{45 \times 3} = \frac{(m+45) \times 150 \times 30}{75 \times 5}$$

$$m = 55$$

55 men should be employed.

- 61) 8 men working 9 hrs per day complete a work in 20 days. In how many days can 7 men working 10 hrs a day complete the same work.

$$8 \times 9 \times 20^2 = 7 \times 10 \times D$$

$$D = \frac{144}{7} \text{ days.}$$



- 62) A contractor employed 200 men for a work. They finish 5/6 of the total work in 10 days, due to rain the work was stopped & 2/5 of the work was destroyed. After rain only 150 men come on work. In how many days the whole work will be completed.

$$\frac{200 \times 10}{5} = \frac{150 \times D}{3}$$

$$D = 8 \text{ days}$$

5 — done.
6 — T.W

5 x 2 — spoiled
5 — 5 → 3
left work = 5 - 2 = 3
or 6 - 3 = 3

- 63) 38 men can complete a work by working 6 hrs per day in 12 days then calculate in how many days 51 men can do a double of the work by working 8 hrs per day. If two men of 1st group doing same work of two men of 2nd group?

$$\frac{38m \times 6 \times 2^3}{1} = \frac{51m \times 8 \times D}{2}$$

2m = 3w

$$D = \frac{228}{17} = 13 \frac{7}{17} \text{ days.}$$

(64) 6 men + 10 women can reap $\frac{5}{12}$ part of 360 hectare land in 15 days by working 6 hrs per day. If now 2 more men & 4 women are employed, then the work will be finished in how many days by working 7 hrs per day. It is also given that work of 2m = 3 women work?

$$\frac{(6m + 10w) \times 6 \times 15}{\frac{5}{12}} = \frac{(8m + 14w) \times 7 \times D}{\frac{1}{12}}$$

$$2m = 3w$$

$$\frac{m}{w} = \frac{3}{2}$$

$$6m + 10w = 6 \times 3 + 10 \times 2 = 38$$

$$8m + 14w = 8 \times 3 + 14 \times 2 = 52$$

$$\frac{19 \times 3}{38 \times 6 \times 15} = \frac{26 \times 13}{52 \times 7 \times D}$$

$$D = \frac{171}{13} = 13 \frac{2}{13} \text{ days}$$

(65) A contractor undertook to finish a work in 150 days and he employs 20 men + 30 women + 75 children. After 60 days only $\frac{1}{4}$ work is complete. Now he have removed all the women & 50 children and employed some more men so that the work will finish in 5 days earlier. find the extra men if 3men = 5women & 2women = 3children.

$$\frac{(20m + 30w + 75c) \times 60}{\frac{1}{4}} = \frac{(20m + 25c + x) \times 85}{\frac{3}{4}}$$

$$\begin{array}{r} 37 \\ 150 \\ -5 \\ \hline 145 \\ -60 \\ \hline 85 \end{array}$$

$x \rightarrow$ extra men.

$$3m_{x_2} = 5w_{x_2}$$

$$2w_{x_5} = 3c_{x_5}$$

$$6m = 10w = 15c$$

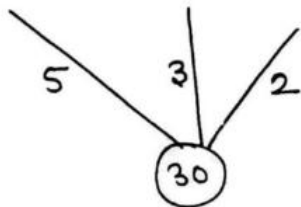

$$\Rightarrow (20m + 30w + 75c) = (20 \times 5 + 30 \times 3 + 75 \times 2) = 340$$

$$20m + 25c + x = 20 \times 5 + 25 \times 3 + x = 150 + x$$

Now,

$$\frac{340 \times 60}{1} = \frac{(150 + x) \times 85}{3}$$

$$\Rightarrow 340 \times \frac{12}{10} \times 3 = (150 + x) \times 85 \Rightarrow x = 114 \text{ आदमी } \underline{\text{Ans}}$$

(66) A does half as much work as B in $\frac{3}{4}$ th time as B. Together they took 18 days to complete the work then how much time shall B take to do it.

$$\frac{A \times 3}{1} = \frac{B \times \frac{3}{4}}{2}$$

$$3A = 2B$$

$$\frac{A}{B} = \frac{2}{3}$$

$$\text{Total work} = (2+3) \times 18 = 90$$

$$A \text{ does} = \frac{90}{2} = 45 \text{ days.}$$

$$B \text{ does} = \frac{90}{3} = 30 \text{ days.}$$

⑥7 A can complete $\frac{3}{4}$ th work of B in $\frac{5}{6}$ time than B. If the whole work completes in 10 days by working together. Then A alone complete the work in how many days?

$$\frac{A \times 5}{3} = \frac{B \times 6}{4 \times 2}$$

$$10A = 9B$$

$$\frac{A}{B} = \frac{9}{10}$$

$$\text{Total work} = (9+10) \times 10 = 190 \text{ unit}$$

$$\begin{aligned} \text{A does} &= \frac{190}{9} \\ &= 21\frac{1}{9} \text{ days.} \end{aligned}$$

$$\text{B does} = \frac{190}{10} = 19 \text{ days.}$$

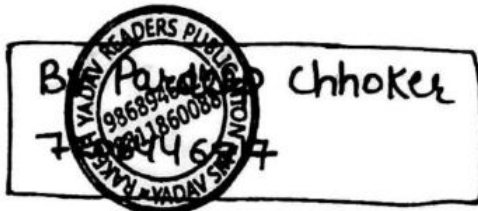

CLASS
5, 6

PIPE AND CISTERNS.

① Two taps A & B can fill a tank in 48 min and 36 min. if both taps are opened together after how much time tap A is closed so that the whole tank fill in 25 min 30 sec.

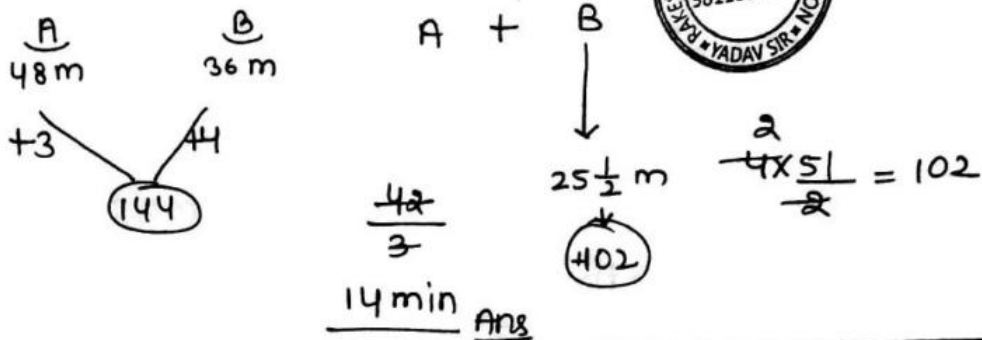

② Two fill pipes A & B can fill a cistern in 18 and 24 min respectively. Both fill pipes are opened together, but 6 minutes before the cistern will fill pipe A is closed. In how much time will the cistern take to fill?

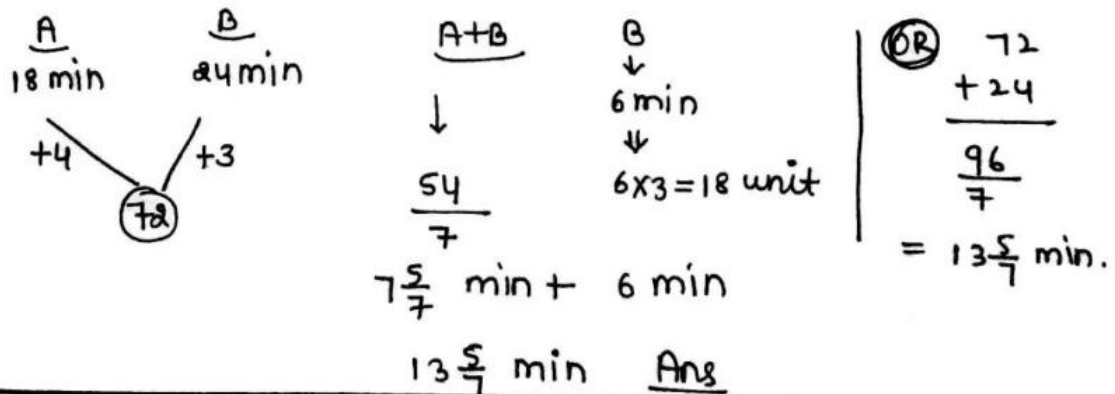

③ Two fill pipes A & B can fill a cistern in 18 & 24 min. respectively. Both fill pipes are opened together but 4 min before the cistern is full, pipe A is closed. How much time will the cistern take to fill.

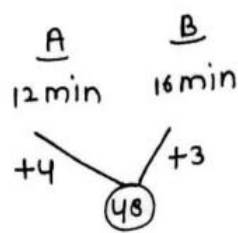

$\frac{A+B}{\downarrow}$ $\frac{B}{\downarrow}$

$\frac{36}{7}$ $4 \times 3 = 12$

$5\frac{1}{7} \text{ min} + 4 \text{ min}$

$= 9\frac{1}{7} \text{ min}$

(or)

$$\frac{48}{+16} = \frac{64}{7} = 9\frac{1}{7} \text{ min}$$

④ A cistern can be filled by two pipes filling separately in 12 & 16 min respectively. Both pipes are opened together, for a certain time out being clogged only $\frac{7}{8}$ of quantity of water flows through the former and only $\frac{5}{6}$ through the latter pipe. The obstruction is removed, the cistern is filled in 3 min from that moment. How long was it before the full flow began.

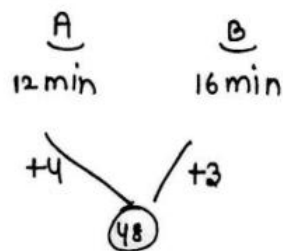

$\frac{A+B}{\downarrow}$ $\frac{A+B}{\downarrow}$

$48 - 21$ 3 min

$= \frac{27}{6}$ \downarrow

$7 \times 3 = 21$

$A = \frac{4 \times 7}{8 \times 2} = 3.5$

$= 4\frac{1}{2} \text{ min}$ Ans. ($4\frac{1}{2}$ min तक खराब रहे)

$B = \frac{3 \times 5}{6 \times 2} = 2.5$

& (~~Total time~~ to fill tank) $= 4\frac{1}{2} + 3 = 7\frac{1}{2} \text{ min}$.

⑤ A cistern can be filled by two pipes in 15 & 25 min respectively. Both pipes are opened together, for a certain time out being clogged, only $\frac{5}{6}$ of quantity of water flows through the former and $\frac{5}{8}$ through the latter pipe. The obstruction is removed, the

cistern is filled in 5 min. from that moment. How long was it before the full flow began.

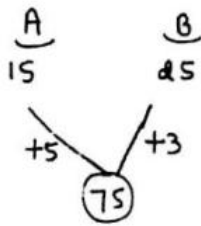

$$\begin{aligned} & \text{A+B} \\ & 75 - 40 \\ & = 35 \text{ unit} \end{aligned}$$

$$\begin{aligned} & \text{A+B} \\ & \downarrow \\ & 5 \text{ min} \\ & \downarrow \\ & 5 \times 8 = 40 \text{ unit} \end{aligned}$$

$$A = 5 \times \frac{5}{6} = \frac{25}{6}$$

$$\Rightarrow \frac{7}{35 \times 24} = \frac{145}{29}$$

$$B = 3 \times \frac{5}{8} = \frac{15}{8}$$

$$\Rightarrow \frac{168}{29} \text{ min } \underline{\underline{\text{Ans}}}$$



decreased efficiency

$$\frac{25}{6} + \frac{15}{8} = \frac{145}{24}$$

⑥ A cistern can be filled by two pipes in 30 & 36 min respectively. Both pipes are opened together for a certain time but being particularly clogged only 5/6 of the full quantity of water flows through the former and only 9/10 through the latter. The obstruction is removed, the cistern is filled in $15\frac{1}{2}$ min from that moment. How long was it before full flow began?

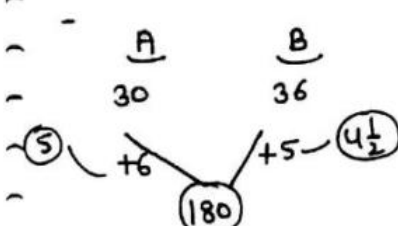

$$\begin{aligned} & \text{A+B} \\ & \downarrow \\ & 180 - 105 \\ & = 75 \end{aligned}$$

$$\begin{aligned} & \text{A+B} \\ & \downarrow \\ & 15\frac{1}{2} \text{ min} \\ & \downarrow \\ & \frac{31}{2} \times 11 \\ & = \frac{341}{2} = 170.5 \text{ unit} \end{aligned}$$

$$A = 6 \times \frac{5}{6} = 5$$

$$\frac{75}{75}$$

$$B = 5 \times \frac{9}{10} = 4.5$$

$$= 1 \text{ min } \underline{\underline{\text{Ans}}}$$

7) Two taps A and B can fill a tank in 30 min & 36 min respectively. Both taps are opened together but due to some problem they work $\frac{5}{6}$ and $\frac{9}{10}$ of their efficiency, after some time the problem was removed and the whole tank will fill in $16\frac{1}{2}$ min. Then after how much time the problem is removed?

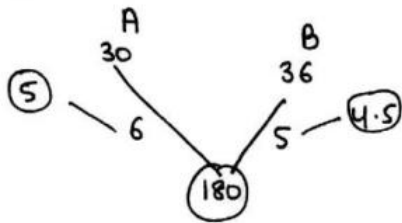

clogged Eff.	full Eff	
$\frac{A+B}{6}$	$\frac{A+B}{10}$	$16\frac{1}{2}$
x min	$(\frac{33}{2} - x)$ min	$= \frac{33}{2}$
\downarrow		
$9.5x$ unit	$11(\frac{33}{2} - x)$ unit	



$$9.5x + 11(\frac{33}{2} - x) = 180$$

$$9.5x + 181.5 - 11x = 180$$

$$x = 1 \text{ min}$$

\therefore Problem was fixed after 1 min. Ans.

OR

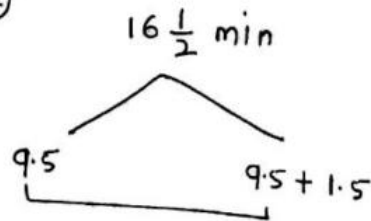

$$\begin{array}{r} 180 \\ - 156.75 \\ \hline 23.25 \end{array}$$

$$\begin{array}{r} 1.5 \rightarrow 23.25 \\ 1 \rightarrow \hline \end{array}$$

$$\frac{9.5}{10} \times \frac{33}{2} = 156.75$$

$$\frac{23.25}{1.5} = 15\frac{1}{2}$$

$15\frac{1}{2}$ min \rightarrow full efficiency से करते हैं.
1 min clogged efficiency से.

- ⑧ Taps A & B can fill a cistern in 20 Hr & 30 Hr resp.
 Both the pipes are opened to fill the tank but when the tank is $\frac{1}{3}$ rd full a leak develops in the bottom of the tank, through which $\frac{1}{3}$ rd of water supply by both pipes leak out. find in how much time the tank will full?

$\frac{A}{20}$	$\frac{B}{30}$	$\frac{C}{-5/3}$	$\frac{A+B}{\downarrow}$	$\frac{A+B-C}{\downarrow}$
$+3$	$+2$	$\frac{-5}{3}$	$60 \times \frac{1}{3} = 20$	$\frac{40}{10} \times 3$
			$\frac{20}{5} = 4 \text{ min}$	$= 12 \text{ min}$

$A+B = 5$

leakage = $-\frac{5}{3}$

$12+4 = 16 \text{ min Ans.}$

Hence eff = $5 - \frac{5}{3} = \frac{10}{3}$

- ⑨ A & B can fill a tank in 15 & 20 Hr respectively. Both the taps are opened together, when the tank was $\frac{1}{4}$ th full a leak develop in the bottom of the tank, through which $\frac{1}{5}$ th of the water supply by both the pipes leak out. find in how many hours tank will full.

$\frac{A}{15}$	$\frac{B}{20}$	$\frac{C}{-7/5}$	$\frac{A+B}{\downarrow}$	$\frac{A+B-C}{\downarrow}$
$+4$	$+3$	$\frac{-7}{5}$	$60 \times \frac{1}{4} = 15$	$\frac{45}{28}$
			$\frac{15}{7} = 2\frac{1}{7} \text{ Hr}$	$= \frac{45 \times 5}{28} = \frac{225}{28}$

leak out = $(4+3) \times \frac{1}{5} = \frac{7}{5}$

$A+B-C = 4+3 - \frac{7}{5} = \frac{28}{5}$

Total time = $\frac{15}{7} + \frac{225}{28} = 10\frac{5}{28} \text{ Hrs.}$

- ⑩ In a tank four taps of equal efficiency are fitted on equal height intervals. The 1st pipe is at the base of the tank and the 4th pipe is at $\frac{3}{4}$ th of height of the tank. Then calculate in how much time the whole tank will empty if the 1st pipe can empty the tank in 12 Hours.

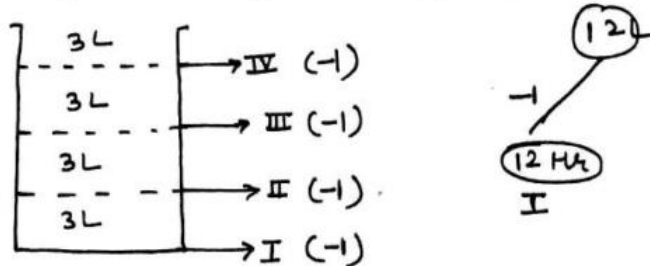

$\frac{3}{4} + \frac{3}{3} + \frac{3}{2} + \frac{3}{1}$ → only 1st pipe is working.

$\frac{9 + 12 + 18 + 36}{12} = \frac{75}{12} = 6\frac{1}{4}$ Hrs.

All 4 pipes are working

- ⑪ Two taps A & B can fill a tank in 10 Hrs & 12 Hrs respectively. There is an outlet tap c. If all the taps are opened together the tank will fill in 30 Hrs. In how many hours tap c alone can empty the tank?

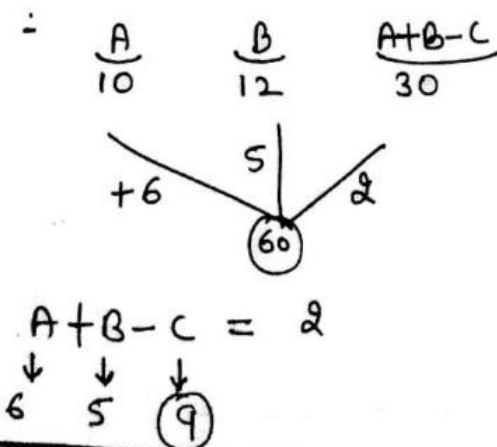

c will empty the tank =

$$\frac{60}{9} = 6\frac{2}{3} \text{ Hrs.}$$

- ⑫ Two pipe A & B can fill a cistern in 1 Hr & 75 min **45** respectively. There is also an outlet pipe C. If all the three pipes are opened together, the tank is full in 50 min. How much time will be taken by C to empty the full tank.

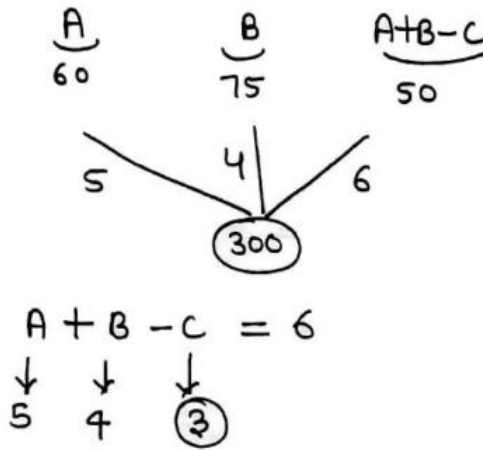

c will empty the tank
in = $\frac{300}{3} = 100$ min.

- ⑬ Two pipes are running continuously to fill the tank. The 1st pipe could have filled it in 5 hrs by itself & 2nd one in 20 hrs. But a 3rd pipe was there to empty it but the operator did not notice it due to which it caused a delay of 1 hr in filling the tank. find the time in which the 3rd pipe would empty the filled tank?

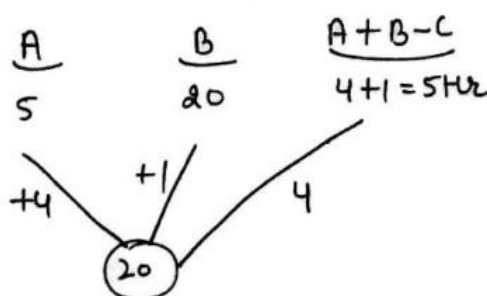

$$A+B-C = 4$$

$$\downarrow \quad \downarrow \quad \downarrow$$

$$4 \quad 1 \quad (-1)$$

c will empty = $\frac{20}{1}$
= 20 hrs.

$$A+B = \frac{20}{5}$$

$$= 4 \text{ hrs}$$

(14) Two pipes can fill a cistern in 14 & 16 hrs respectively. The pipes are opened simultaneously and it is found that due to leakage in the bottom, it took 92 min more to fill the cistern. When the cistern is full, in what time will the leak empty it?

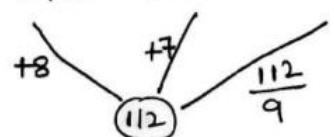
$\frac{A}{14 \text{ Hr}}$ $\frac{B}{16 \text{ Hr}}$ $\frac{A+B-C}{9 \text{ Hr}}$

 $A+B = \frac{112}{15} \times \frac{4}{60}$
 $= 448 \text{ min}$
 $A+B-C = 92 \text{ min more}$
 $448 + 92 = 540 \text{ min}$
 $\frac{540}{60} = 9 \text{ Hrs.}$



$$A+B-C = \frac{112}{9}$$

$$\downarrow \quad \downarrow$$

$$8 + 7$$

$$15 - C = \frac{112}{9}$$

$$C = 15 - \frac{112}{9} = \frac{23}{9}$$

$$C \text{ will empty} = \frac{112}{\frac{23}{9}}$$

$$= \frac{112 \times 9}{23} = \frac{1008}{23}$$

$$= 43 \frac{19}{23} \text{ Hrs } \underline{\underline{\text{Ans}}}$$

(15) Three pipes A, B and C are attached to a cistern. A & B can fill it in 30 Hrs and 20 Hrs respectively & 3rd pipe C leaks out 45 L water per minute. If all the three pipes are opened simultaneously the tank will fill in 15 Hr. find the capacity of the tank.

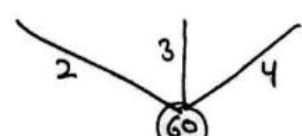
$\frac{A}{30 \text{ HR}}$ $\frac{B}{20 \text{ HR}}$ $\frac{A+B-C}{15 \text{ HR}}$

 $A+B-C = 4$
 $\downarrow \quad \downarrow \quad \downarrow$
 $2 \quad 3 \quad \textcircled{1}$ $C = 1$

$C \text{ will empty the tank} = \frac{60}{1} = 60 \text{ Hrs}$
 Efficiency of C of taking out = 45 litre/min
 Capacity of Tank = $60 \times 60 \times 45$
 $= 162000 \text{ Ltr.}$

- 16) A leak in the bottom of the tank can empty it in 6 Hrs. A tap fill the tank @ 4L/min is turn on. if both taps are opened then the tank will empty in 8 Hrs. Find the capacity of the tank ?

$$\begin{array}{r} \frac{A}{-6\text{Hr}} \qquad \frac{-A+B}{-8\text{Hr}} \\ \swarrow \quad \searrow \\ -4 \qquad -3 \\ \qquad \quad \circlearrowleft 24 \end{array}$$

$$\begin{array}{r} -A+B = -3 \\ \downarrow \quad \downarrow \\ -4 \quad \circlearrowleft +1 \end{array} \quad \boxed{B=1}$$

B will fill the tank = $\frac{24}{1} = 24\text{Hrs}$
 B can fill 4 litre/min
 \therefore capacity of Tank = $24 \times 60 \times 4$
 = 5760 litre.

- 17) A leak in the bottom of a tank can empty it in 12 Hrs. A tap which can added 20L/min is turn on. Both the taps are opened now, then the tank is emptied in 20 Hrs. find the capacity of the tank.

$$\begin{array}{r} \frac{A}{-12\text{Hr}} \qquad \frac{-A+B}{-20\text{Hr}} \\ \swarrow \quad \searrow \\ -5 \qquad -3 \\ \qquad \quad \circlearrowleft 60 \end{array}$$

$$\begin{array}{r} -A+B = -3 \\ \downarrow \quad \downarrow \\ -5 \quad \circlearrowleft +2 \end{array} \quad \boxed{B=2}$$

B will fill = $\frac{60}{2} = 30\text{Hrs}$
 B can fill 20 litre/min
 \therefore capacity of Tank = $30 \times 60 \times 20$
 = 36000 litre.



(18) 8 taps are fitted in a tank, some are water taps & rest are outlet tap. Each water tap can fill the tank in 12 Hrs and each outlet tap can empty in 36 Hours. Then calculate the no. of water taps if the whole tank fill in 3 Hrs.

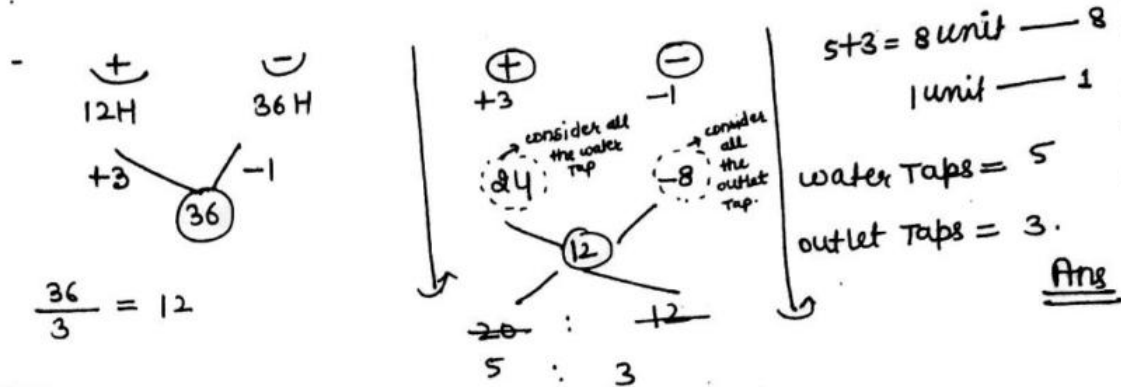

(19) 12 taps are fitted in a tank, some are water taps & rest are outlet taps. Each water tap can fill the tap in 6 Hr and each outlet tap can empty the tap in 12 Hr. If all the taps are open together then the tank is full in 4 Hrs. find the no. of water taps.

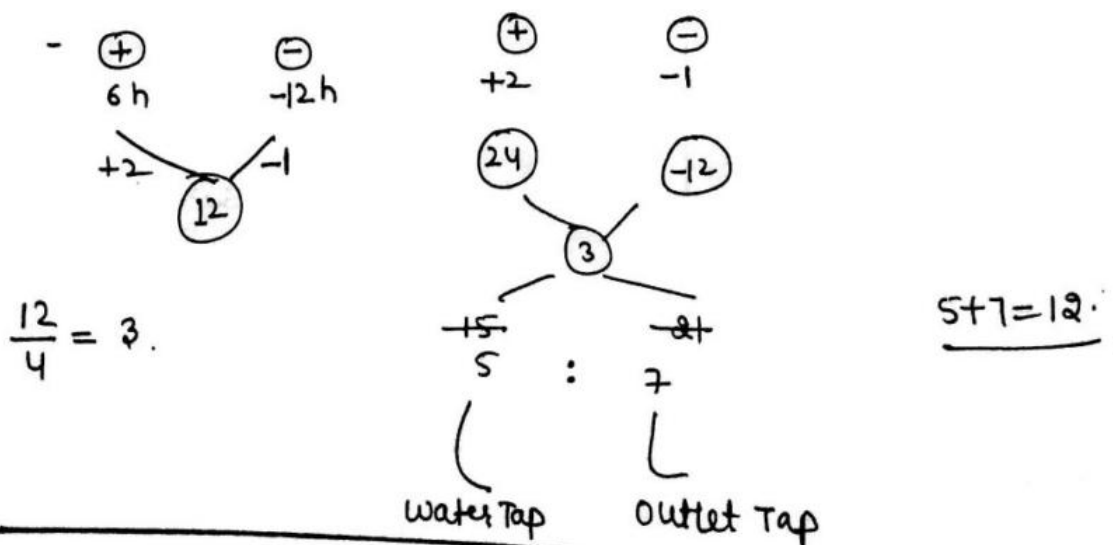

(20) A tank is connected with 8 pipes. Some of them are inlet pipes and rest are outlet pipes. Each of the inlet pipe can fill the tank in 8 hrs individually while each outlet pipe can empty the tank in 6 hrs individually. If all the pipes are kept open when the tank is full, it will take 6 hrs for the tank to empty. How many of these are inlet pipes?

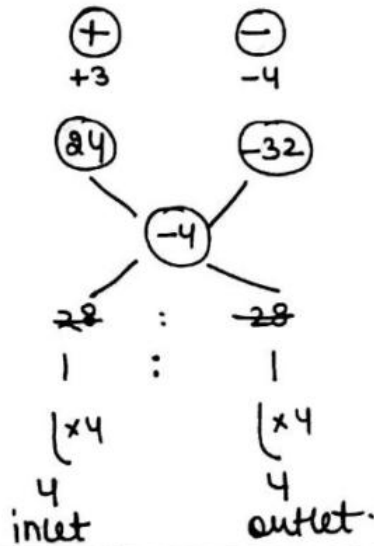
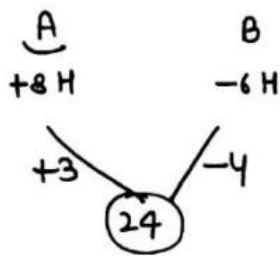

$$\frac{24}{6} = -4.$$

$$1+1=2 \rightarrow 8$$

$$1 \rightarrow 4$$

(21) If A & B can fill a tank in 10 hrs & 15 hrs respectively. An outlet tap C can empty it in 20 hrs. Initially the tap A and tap B are opened and when the tank was supposed to be filled it was found that tap C was open mistakenly, now C is closed. After how much time tank will fill?

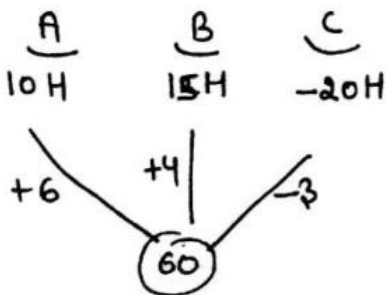

$$C = -3 \times 6 = -18$$

$$A \& B \text{ fill it} = \frac{18}{10}$$

$$= 1 \frac{4}{5} \text{ hrs.}$$

$$(A+B) = \frac{60}{10} = 6 \text{ hrs}$$

(22) A bath can be filled by the cold water pipe in 10 minutes and by the hot water pipe in 15 minutes. A person leaves the bathroom after turning on both pipes simultaneously and returns at the moment when the bath should be full. finding however, that the waste pipe has been open, he now closed it. In 4 min more the bath is full. In what time would the waste pipe empty it?

$$\begin{array}{r}
 \begin{array}{cc}
 \text{A} & \text{B} \\
 10 & 15 \\
 +3 & +2 \\
 \hline
 30
 \end{array} \\
 A+B = \frac{30}{5} = 6 \text{ hrs}
 \end{array}$$

$$\begin{aligned}
 \frac{3}{6} \times \text{waste pipe} &= (A+B) \times 4 + 2 \\
 3 \times \text{waste pipe} &= (3+2) \times 2 \\
 3 \times \text{waste pipe} &= 10 \\
 \text{waste pipe} &= \frac{10}{3} \\
 \text{waste pipe will empty} &= \frac{30}{10/3} = \frac{30 \times 3}{10} \\
 &= 9 \text{ min}
 \end{aligned}$$

(23) A monkey climb a pole of height 100 m. It climbs 6 m above in 1st min and 4 m below in 2nd min. In how many minutes monkey will climb on the pole?

$$\begin{array}{r}
 \begin{array}{cc}
 6 \text{ mt} & -4 \text{ mt} \\
 \uparrow & \downarrow \\
 1^{\text{st}} & 2^{\text{nd}}
 \end{array} \\
 \text{1 cycle (2 min)} & \text{---} & 2 \text{ mt.} \\
 \downarrow \times 47 & & \downarrow \times 47 \\
 94 \text{ min} & \text{---} & 94 \text{ mt} \\
 1 \text{ min} & \text{---} & 6 \text{ mt} \\
 \hline
 95 \text{ min} & & \hline
 & & 100 \text{ m}
 \end{array}$$



24) A monkey climb a pole of height 60 m. It climb 5 m above in 1st min and 4 m below in 2nd min. In how many minutes monkey will climb on the pole?

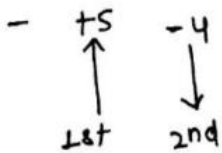

1 cycle (2 min) — 1 mt.
↓ x 55
110 min
1 min
111 min

Starting में इतने चक्कर लगावते हैं कि दूध (-) वाली term से ज्यादा रहे।

↓ x 55
55 mt.
5 mt.
60 mt.

25) A, B, C are pipes attached to a cistern. A & B can fill it in 20 min & 30 min respectively while C can empty in 15 min. If A, B, C kept open successively for 1 min each, how soon the cistern will be filled?

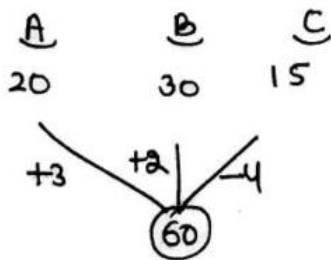

A	B	C
+3	+2	-4



1 cycle (3 h) — 1
↓ x 55
165
1 min
1 min
167 min

x 55
55
+3
+2
60

26) Tap A and Tap B can fill a tank in 10 Hrs & 12 Hrs respectively. Tap C can empty it in 12 Hrs. If all the taps are open alternatively 1 Hr each, then the whole tank will fill in how many hours.

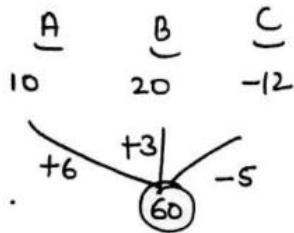

A	B	C
+6	+3	-5
1 cycle (3H) ——— 4		
x13		
39H		
1h		
<u>2/3 h</u>		
40 2/3 Hr.		

4
x13
52
+6
<u>2</u>
60

27) Three pipes A, B, C are attached to a cistern. Pipe A & B can fill the cistern in 20 & 30 Hr respectively and the pipe C can empty in 60 Hrs. Pipe A & C are opened for the 1st Hour and the pipe B & C are opened for the 2nd Hour & this process continues till the cistern does not fill. In how much time the tank will be filled?

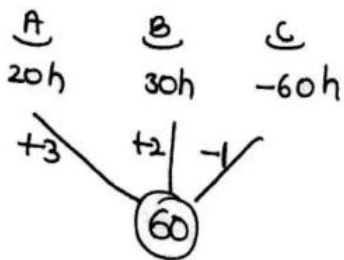

I	II
A+C	B+C
1/2	1/3
1 cycle (2 Hr) ——— 8 unit	
x20	
40 Hr	
x20	
60 unit	

(28) In what time would a cistern is filled by 3 pipes 53 whose diameters are 1cm, $1\frac{1}{3}$ cm, 2cm running together, when the largest alone fill it in 61 min. The amount of water flowing in by each pipe being proportional to the square of its diameter?

- D \rightarrow 1 : $\frac{4}{3}$: 2 capacity of tank = 36×61
 D \rightarrow 3 : 4 : 6 $\Rightarrow 9 + 16 + 36 = 61$
 Eff \rightarrow 9 + 16 + (36) cistern will fill = $\frac{36 \times 61}{61} = 36 \text{ min}$

(29) In what time would a cistern be filled by 3 pipes whose diameters are 1cm, 2cm, 4cm running together. When the largest alone fill it in $1\frac{1}{20}$ Hours, the amount of water flowing in by each pipe being proportional to the square of its diameter.

- D \rightarrow 1 : 2 : 4 capacity of tank = $16 \times \frac{21}{20}$
 Eff \rightarrow 1 : 4 : 16 (16) Tank will fill = $\frac{16 \times \frac{21}{20}}{21}$
 $1 + 4 + 16 = 21$ $\frac{16 \times 21}{20} \times \frac{1}{21} = \frac{4}{5} \text{ Hr.}$

(30) One fill pipe A take three min more to fill the tank than two pipes A & B opened together to fill it. 2nd fill pipe B takes $21\frac{1}{3}$ min more to fill the tank than A & B together take. When the tank will be full if both pipes are opened simultaneously?

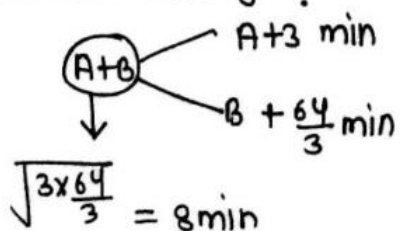

A+B will fill = 8 min Ans

(31) $3m + 4b$ can earn Rs 756 in 7 days. $11m + 13b$ can earn Rs 3008 in 8 days. In what time will 7 men + 9 boys earn Rs 2480.?

$$\frac{(3m+4b) \times 7}{756 + 108} = \frac{(11m+13b) \times 8}{3008}$$

$\frac{756}{+108}$
 54

$\frac{3008}{374}$
 187

$$\frac{m}{b} = \frac{5x}{3x}$$

$$(3m+4b) = (15x+12x) = 27x$$

$$(11m+13b) = (55x+39x) = 94x$$

$$27x \times 7 = 756 + 108$$

$$x = 4$$

$$\frac{m}{b} = \frac{20}{12}$$

$$7m + 9b = 140 + 108 = 248$$

$$(7m+9b) \text{ will earn in } \frac{2480}{248} = 10 \text{ days.}$$

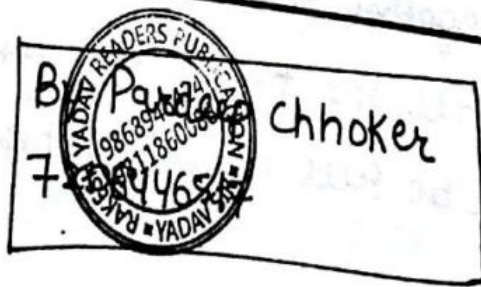

CLASS
7

TIME AND DISTANCE

① A man cover a certain distance with x km/Hr & come back with y km/Hr. He takes t hrs to go and come back. find the distance ?

x km/Hr y km/Hr

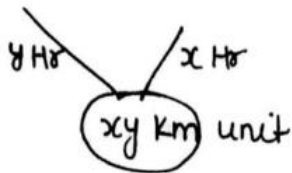

$(x+y)$ unit ——— t hr.

1 unit ——— $\frac{t}{x+y}$

xy ———→ $\frac{t}{x+y} \times xy$ km.

$$D = \frac{S_1 \times S_2}{S_1 + S_2} \times [\text{Total Time}]$$



② A boy goes to school at 3 km/Hr. and return at a speed of 2 km/Hr. if he takes 5 Hrs in all. find the distance from his village to school?

$$D = \frac{3 \times 2}{3+2} \times 5 = 6 \text{ km. } \underline{\text{Ans}}$$

③ A man travel a certain distance by train @ 25 km/Hr. — and walk back @ 4 km/Hr. The whole journey took 5 Hr 48 min, what distance did he travel by train.

$$D = \frac{25 \times 4}{25+4} \times \frac{29}{5} = 20 \text{ km}$$

$$\begin{aligned} &5 \text{ Hr } 48 \text{ min} \\ &= 5 \frac{4}{5} \\ &= \frac{29}{5} \end{aligned}$$

- ④ A man go a certain distance with x km/Hr and he ⁵⁶ comes back with a speed of y km/Hr. If he takes t hrs more to come back than go. find the distance.

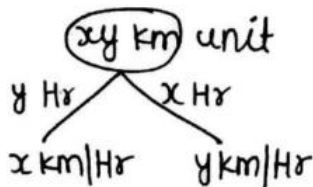

$$D = \frac{S_1 \times S_2}{S_1 - S_2} \text{ [diff. b/w time]}$$

$$(x-y) \text{ unit} \text{ --- } t$$

$$1 \text{ unit} \text{ --- } \frac{t}{x-y}$$

$$xy \text{ unit} \text{ --- } \frac{t}{x-y} \times xy$$



- ⑤ A man cover a certain distance from house to office if he travel @ 30 km/Hr, then he is late by 10 min but if he travel @ 40 km/Hr then he reaches his office 5 min earlier. Find the distance from home to office.

$$\text{Time diff} = 15 \text{ min}$$

$$D = \frac{30 \times 40}{40 - 30} \times \frac{15}{60} = 30 \text{ km} \quad \underline{\text{Ans}}$$

- ⑥ Starting from his house one day, a student walks @ 2.5 km and reaches his school 6 min late. Next day he \uparrow his speed 1 km/Hr and reaches the school 6 min earlier. how far is the school from his house.

$$\text{Time diff} = 12 \text{ min}$$

$$S_1 = 2.5 \text{ km/Hr}, S_2 = 2.5 + 1 = 3.5 \text{ km/Hr}$$

$$D = \frac{S_1 \times S_2}{S_2 - S_1} \times \frac{12}{60} = \frac{2.5 \times 3.5}{3.5 - 2.5} \times \frac{1}{5} = \frac{7}{4} \text{ km.}$$

⑦ A man cover a certain distance by 10 km/Hr and becomes 15 min late. But if he travel the same distance with 12 km/Hr then he becomes 5 min late find the distance ?

Time diff = 10 min

$$D = \frac{10 \times 12^2}{2} \times \frac{10}{60-6} = 10 \text{ km.}$$

⑧ A man cover a certain distance on scooter and he travel 3 km per hr faster he would have taken 40 min less. But if he decrease his speed 2 km/Hr then he becomes 40 min late. find the distance.

$$D = \frac{s \times (s+3)}{3} \times \frac{40}{60} = \frac{s(s-2)}{2} \times \frac{40}{60} \quad \begin{array}{l} \text{Time diff} = 40 \text{ (in 1st case)} \\ \text{\& 40 (in 2nd case)} \end{array}$$

$$\Rightarrow 2s+6 = 3s-6$$

$$s = 12 \text{ km/Hr.}$$

$$D = \frac{12 \times 15}{3} \times \frac{40}{60} = 40 \text{ km/Hr.}$$

⑨ A man cover a certain distance by his car. Had he travel 6 km/Hr faster then he take 4 hr less time. But if he drive 6 km/Hr slower then he takes 6 Hrs more. find the distance.

$$\frac{s \times (s+6)}{s-6} \times 4^2 = \frac{s \times (s-6)}{s+6} \times 6$$

$$2s+12 = 3s-18$$

$$s = 30 \text{ km/Hr}$$

$$D = \frac{30 \times 36}{6} \times 4 = 720 \text{ km}$$

Ans.

- ⑩ A man travel a certain distance by his car. If he ⁵⁸ increase his speed 10 km/Hr then he would take 1 Hr less time. But if he further increase his speed 10 km/Hr then he takes further 45 min lesser time. find the distance ?

$$\frac{S \times (S+10)}{10} \times 1 = \frac{S(S+20)}{20} \times \frac{7}{4}$$

$$1 \frac{45}{60} = \frac{7}{4}$$

$$1 \frac{3}{4} = \frac{7}{4}$$

$$8S + 80 = 7S + 140$$

$$S = 60 \text{ km/Hr}$$

$$D = \frac{60 \times 70}{10} \times 1 = 420 \text{ km.}$$

- ⑪ If a man had walk 20 km/Hr faster he would have save 1 Hr in the distance of 600 km. find his usual speed ?

$$\frac{S \times (S+20)}{20} \times 1 = 600$$

$$\Rightarrow S \times (S+20) = 12000 \text{ km.}$$



Took value of S from options.

$$\frac{100 \times (100+20)}{S \times (S+20)}$$

$$S = 100 \text{ km/Hr.}$$

- ⑫ In a flight of 600 km an aircraft slow down due to bad weather, its avg speed for the trip reduced by 200 km/Hr & the time of flight increased by 30 min. find the original speed ?

$$\Rightarrow \frac{S \times (S-200)}{200} \times \frac{1}{2} = 600$$

$$\Rightarrow S \times (S-200) = 600 \times 400$$

$$\downarrow$$

$$600$$

$$S = 600 \text{ km/hr.}$$

CLASS

8

By  Chhoker

7206146977

- ⑬ If a train with a speed of 60 km/hr cross a pole in 30 sec. find the length of the train?

$$\text{km/hr} \times \frac{5}{18} = \text{m/sec}$$

Distance = speed \times Time.

$$\text{m/sec} \times \frac{18}{5} = \text{km/hr}$$

$$\frac{60}{10} \times \frac{5}{18} \times 30^{10} = 500 \text{ mtr.}$$

- ⑭ A 100 m long train with a speed of 30 km/hr can cross a man in how much time?

$$100 = 30 \times \frac{5}{18} \times T$$

$$T = 12 \text{ sec.}$$

- ⑮ A train running at a speed of 72 km/hr crossed a 260 m platform in 23 sec. find the length of train?

$$260 + \text{Train length} = 72 \times \frac{5}{18} \times 23 = 460$$

$$\text{Train length} = 460 - 260 = 200 \text{ mtr.}$$

⑩ A 275 m long train crosses a platform of equal length in 33 sec. find the speed of the train?

Total distance covered by train to cross the

$$\text{platform} = 275 + 275 = 550\text{m}$$

$$550 = S \times 33$$

$$S = \frac{550}{33} = \frac{50}{3} \text{ m/sec} = \frac{10}{3} \times \frac{18}{5} = 60 \text{ km/hr}$$

⑪ A train running at a speed of 60 km/hr crosses a platform double of its length in 32.4 sec. find the length of the platform?

$$\text{length of train} = x$$

$$\text{length of platform} = 2x$$

$$\text{Total distance in crossing} = x + 2x = 3x$$

$$3x = \frac{60 \times 5}{18} \times \frac{32.4}{10} = 180$$

$$x = 180$$

$$\text{length of train} = 180 \text{ m}$$

$$\text{length of platform} = 180 \times 2 = 360 \text{ m.}$$



Relative speed

→ S₁ Two objects in same direction

→ S₂ Relative speed = (S₁ - S₂)

→ S₁ Two objects in opposite direction

← S₂ Relative speed = (S₁ + S₂)

⑱ A train crosses a man with a speed of 72 km/hr in 15 sec. find in how much time it will cross another train which is 50% more long than it if the other train is standing on platform?

$$\text{length of Train}_1 = 72 \times \frac{5}{18} \times 15 = 300 \text{ m}$$

$$\text{length of Train}_2 = 50\% \text{ more} = \frac{150}{100} \times 300 = 450 \text{ m}$$

Total distance to be covered by Train 1 in crossing

$$\text{Train 2} = 300 + 450 = 750 \text{ m}$$

$$\frac{150}{750} = \frac{4}{72 \times \frac{5}{18}} \times T$$

$$T = \frac{150}{4} = 37\frac{1}{2} \text{ secs.}$$

⑲ A train crosses a tunnel half of its length with a speed of 72 km/hr in 1 min, then find in how much time it will cross another train of double length w/c is standing on platform with 60% of its speed?

$$\text{Train length} = 2L$$

$$\text{Tunnel length} = L$$

$$3L = 72 \times \frac{5}{18} \times 60$$

$$L = 400 \text{ m.}$$

$$\text{Train 1} = 400 \times 2 = 800 \text{ m}$$

$$\text{Train 2} = 2 \times 800 = 1600 \text{ m}$$

$$T_1 = 800$$

$$T_2 = 1600$$

Total distance in crossing = 2400

60% of speed = 12 m/sec.

$$\therefore 2400 = 12 \times t$$

$$T = 200 \text{ sec. } \underline{\underline{\text{Ans}}}$$

- ②0 2 trains of same length can cross a pole in 7 sec & 9 sec. respectively. In how much time will they cross each other if they are coming from opposite direction.

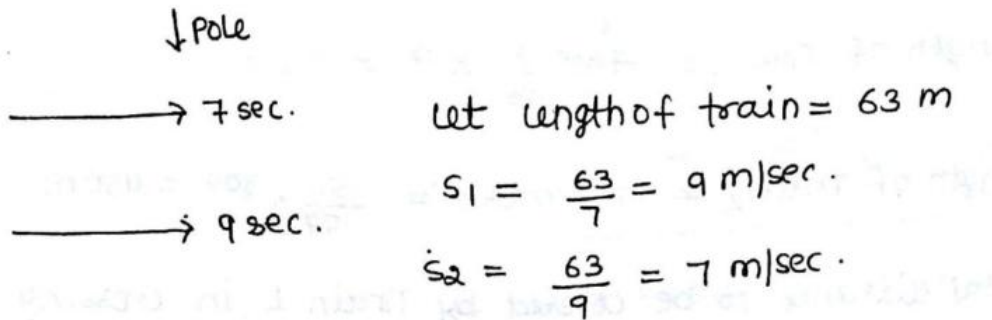

Time of cross = $\frac{126}{16} = \frac{63}{8}$ sec.

- ②1 2 trains can cross a pole in 4 sec and 6 sec respectively. Find in how much time will they cross each other if they are coming from same direction & if the speed of the trains are in 7:9 ratio.

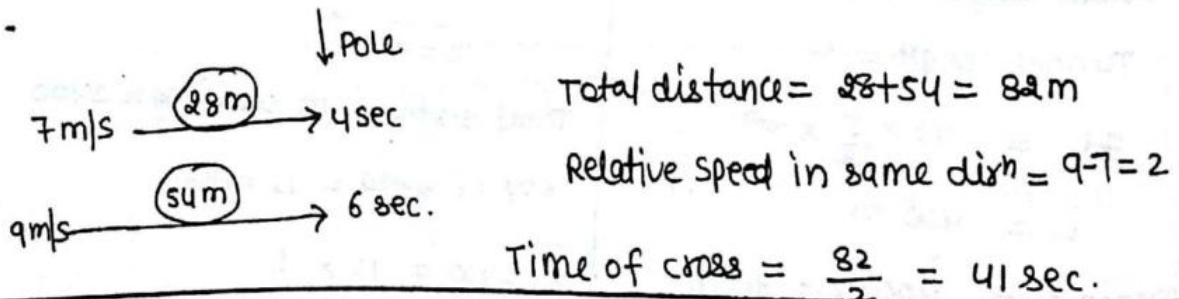

- ②2 The speed of two train in the ratio 3:4. Both crosses a pole in 3 sec while coming from opposite direction. In how much time they will cross each other?

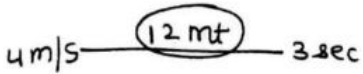
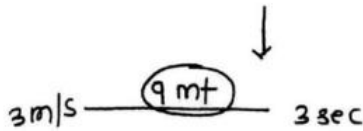

Total distance = $9 + 12 = 21$

Relative speed in opposite

dirn = $3 + 4 = 7$

Time of cross = $\frac{21}{7} = 3 \text{ sec}$ Ans

23) A goods train and passenger train are running in same direction with a speed in the ratio 1:2. The driver of goods train observes that the passenger train coming from behind overtake and crossed his train completely in 60 sec. whereas a passenger on passenger train looks that he cross the goods train in 40 sec. find the ratio of their length.

Goods Train (G) = 1 m/sec

Passenger Train (P) = 2 m/sec.

Relative speed in same

direction = $2 - 1 = 1 \text{ m/sec}$

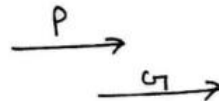

$P + G = 1 \text{ m/sec} \times 60$

$P + G = 60 \text{ mt.}$

$G \rightarrow 1 \text{ m/sec.}$

man $\rightarrow 2 \text{ m/sec.}$

$G = 1 \text{ m/sec} \times 40$

$G = 40 \text{ mtr.}$

$P + G = 60$
 $\downarrow \quad \downarrow$
 $20 \quad 40$

$G : P$

$40 : 20$

$2 : 1$ Ans



G	:	P
(Time Taken by Passenger)	-	Time Taken to cross both train each other
		Time Taken to cross the goods train by passenger

(24) The ratio of speeds of a goods and passenger train is 7:9 in same direction. If the passenger train crosses the goods train in 60 sec while a passenger in the passenger train observes that he crosses the goods train in 35 sec. find the ratio of length of goods train to passenger train ?

length of Good Train (G) = 7 m/sec

length of Passenger Train (P) = 9 m/sec

Relative speed in same dirⁿ = 9-7 = 2 m/sec.

$(P+G) = 2 \times 60 = 120$

$G \rightarrow 7 \text{ m/sec}$

man $\rightarrow 9 \text{ m/sec}$

Relative Speed = 9-7 = 2

$G = 2 \times 35 = 70$

$\therefore P + G = 120$

\downarrow
50 \downarrow
70

G : P

70 : 50

7 : 5

Ans

OR

G : P

35 : 60-35

~~35~~ : 25

7 : 5 Ans

25 A train overtakes a man going along the railway track at a speed of 6 km/Hr in 10 sec if the length of the train is 200 m. Find the speed of the train? 65

Train 200 → x km/Hr

→ man 6 km/Hr
10 sec.

$$200 = (x-6) \times \frac{5}{18} \times 10$$

$$x = 78 \text{ km/Hr}$$

By Pardeep Chhoker
7206446517

26 A gun is fired from behind a train the driver of train hears the sound $1\frac{1}{2}$ min later than guard. find the length of train if the speed of train & sound are 60 km/Hr and 1100 m/min.

Train → 1000 m/min

$$\frac{60,000}{60} = 1000 \text{ m/min.}$$

• → 1100 m/min
Sound

$$D = \underbrace{100}_{\substack{\downarrow \\ \text{Relative speed} \\ \text{in same dir.}}} \times \frac{3}{2} = 150 \text{ mt.}$$

27 A train can cross 2 men going along the railway track at 4 km/Hr & 5 km/Hr in same direction in 10 sec & 12 sec. find the length of train.

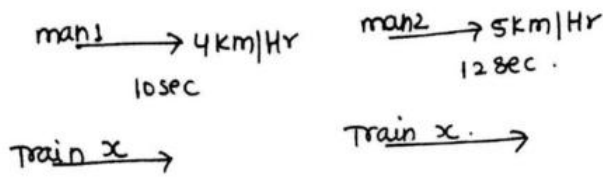

$$(x-4) \times \frac{5}{18} \times 10 = (x-5) \times \frac{5}{18} \times 12$$

(∵ both are length of trains. so equate them)

$$5x-20 = 6x-30$$

$$x = 10 \text{ km/Hr.}$$

length of train = $(10-4) \times \frac{5}{18} \times 10 = \frac{50}{3}$ metre
Ans.

OR

$$10 \times 4 = 40$$

$$12 \times 5 = 60$$

$$12-10 = 2$$

$$\text{Speed} = \frac{60-40}{2} = 10 \text{ km/Hr}$$

$$\text{length} = (10-4) \times \frac{5}{18} \times 10 = \frac{50}{3} \text{ metre.}$$

28 A train pass two person who are walking in opposite in w/c the train that is moving @ 5 m/sec & 10 m/sec. in 6 sec and 5 sec respectively. find the length of train.



$$(x+5) \times 6 = (x+10) \times 5$$

$$x = 20 \text{ m/sec.}$$

$$\text{length of train} = (20+5) \times 6 = 150 \text{ mtr.}$$

Ans.

OR

$$5 \times 6 = 30$$

$$10 \times 5 = 50$$

$$\frac{50-30}{1} = 20 \text{ m/sec.}$$

$$\text{length} = (20+5) \times 6 = 150 \text{ mtr.}$$

29 Two trains of length 100 m & 80 m respectively run on parallel line. If they run in same direction they cross each other in 18 sec But if they are coming from opposite direction they cross each other in 9 sec. find the speed of faster train.

किसी भी direction में cross करे distance $(100+80) = 180$ ही होगा cross करने के लिए ।

Speed of 1st train (x)

speed of 2nd train (y)

$$x - y = 10$$

$$\underline{x + y = 20.}$$

$$x = 15 \text{ km/hr}$$

$$y = 5 \text{ m/sec.}$$



$$\frac{180}{18} = 10$$

$$\frac{180}{9} = 20$$

30 A truck crosses a man moving along the road at 6 km/hr. The man could see the truck upto 2 min find the speed of truck, at the time of disappearance the distance of truck to man is 1.2 km ?

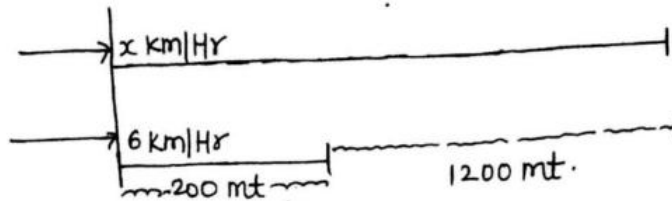

$$\begin{aligned} \text{distance travelled by man in 2 min} &= 6 \times \frac{2}{60} \\ &= 0.2 \text{ km} = 200 \text{ mt.} \end{aligned}$$

$$\text{distance covered by truck} = 200 + 1200 = 1400 \quad \left| \quad \text{Time} = \frac{2}{60} = \frac{1}{30} \text{ hr.} \right.$$

$$S = \frac{D}{T} = \frac{1400}{\frac{1}{30}} = 1400 \times \frac{30}{1} = 42 \text{ km/Hr.}$$

(OR)

$$D = S \times T$$

$$1.2 = (x-6) \times \frac{2}{60}$$

$$36 = x - 6$$

$$x = 42 \text{ km/Hr}$$



31] A carriage driving in a fog passed a man who was walking at the rate of 3 km/Hr in same direction. He could see the carriage for 4 min & it was visible to him upto a distance of 100 m. What was the speed of the carriage?

$$D = S \times T$$

$$100 \text{ m} = \frac{1}{10} \text{ km}$$

$$\frac{1}{10} = (x-3) \times \frac{4}{60}$$

$$3 = 2x - 6$$

$$x = 4.5 \text{ km/Hr.}$$

32] A train crosses a man going along the railway track at 6 km/Hr. The man could see the train upto 2 min and then find the speed of the train if at the time of disappearance the distance b/w train to man was 1.2 km ? & length of train is 300 metre ? 69

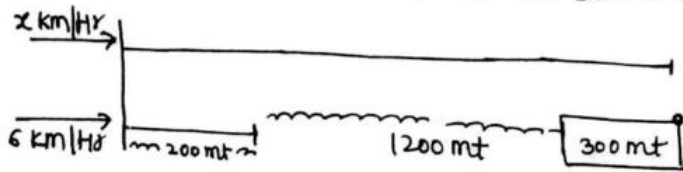

distance covered by man in 2 min = 200 mtr.

Total distance by train = 200 + 1200 + 300 = 1700 mtr.

$$T = 2 \text{ min} = \frac{1}{30} \text{ Hr.}$$

$$S = \frac{1.7}{\frac{1}{30}} = 51 \text{ km/Hr}$$

OR

$$1.5 = (x-6) \times \frac{2}{60}$$

$$x = 51 \text{ km/Hr.}$$



33] A man could see 400 m during fog when he was moving with 4 km/Hr, he saw a train coming from behind & disappeared in 3 min. If the length of train is 200 m, find the speed of the train ?

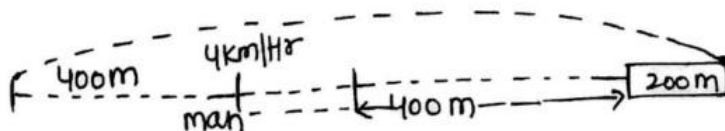

Total distance by train = 400 + 400 + 200 = 1000 m = 1 km

$$1 = (x-4) \times \frac{3}{60 \times 20}$$

$$x = 24 \text{ km/Hr}$$

$$D = S \times T$$

[अगर detail solve करेंगे तो man का 3 min का distance भी लेंगे] .

- 34 A car is 120 m behind the bus, in how much time ⁷⁰ it will be 760 m ahead of bus if their speed are 48 km/Hr and 30 km/Hr ?

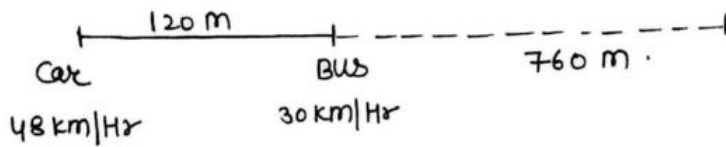

$$\begin{aligned}\text{Relative Speed} &= 48 - 30 = 18 \text{ km/Hr} \\ &= 18 \times \frac{5}{18} = 5 \text{ m/sec.}\end{aligned}$$

distance to be covered by $\frac{\text{bus}}{\text{car}} = 120 + 760 = 880$.

$$\text{Time} = \frac{880}{5} = 176 \text{ sec. } \underline{\text{Ans.}}$$

CLASS

9

By Pardeep Chhoker

7206446517

-
- 35 A theft is reported at 10 pm and police started chasing the thief at 1:00 am. calculate at what time the police will catch the thief, if speed of thief and police are 42 km/Hr and 49 km/Hr.

10:00 pm \rightarrow 42 km/Hr

1:00 am \rightarrow police have to cover 42×3 km distance

with Relative speed = $49 - 42 = 7$ km/Hr

$$\text{Time} = \frac{42 \times 3}{7} = 18 \text{ Hrs.}$$

36) A boy plants a bomb at a place and starts running at 30 m/sec. After 56 sec the bomb was blast, in how much time the sound of blast will be listen by the boy if the speed of sound is 450 m/sec.

Boy \rightarrow 30 m/sec

sound \rightarrow 450 m/sec.

distance travelled by boy in 56 sec = 30×56 m

Relative speed of sound w.r.t. boy = $450 - 30 = 420$ m/sec.

Time = $\frac{30 \times 56}{420} = 4$ sec.

\therefore After 4 sec. boy will hear the sound of blast.

37) A dog chases rabbit. The rabbit is 125 leaps ahead of itself jumps from dog. The rabbit can jump 4 times in a time in which the dog can jump 3 times. The distance covered by the rabbit & dog in one jump is 1.75 and 2.75 m. In how many jumps the dog will catch the rabbit?

R	D
1.75	2.75
7	11

Dog = $3 \times 11 = 33$ m/sec.

Rabbit = $4 \times 7 = 28$ m/sec.

\downarrow
distance in one jump.



distance covered by Rabbit in

125 jump = 125×7

Relative speed of dog w.r.t rabbit
 $33 - 28 = 5$ m/sec.

chasing Time = $\frac{125 \times 7}{5}$

= 175 sec Ans.

jumps = $175 \times 3 = 525$ jumps Ans

- 38] 2 trains for delhi leaves jaipur at 8:30 am & 9:00 am 72
and travel at 60 km/hr and 75 km/hr respectively.
How many km away from jaipur will the two train
meet ?

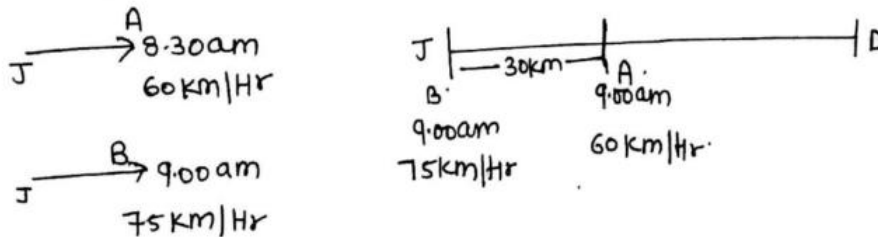

distance travelled by A in 30 min = $\frac{1}{2} \times 60 = 30$ km.

Relative speed = $75 - 60 = 15$ km/hr

Time of catch = $\frac{30}{15} = 2$ hr.

From Jaipur they will meet $\Rightarrow 75 \times 2 = 150$ km.

- 39] A train travelling 25 km/hr leaves delhi at 9:00 am,
another train travelling 35 km/hr at 2:00 pm, in the
same direction. How many train km from delhi
will they meet together ?

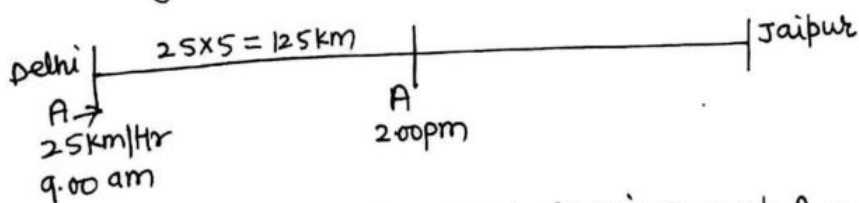

Relative speed of Train B w.r.t. A = 10 km/hr

Time of catch = $\frac{125}{10} = \frac{25}{2}$ hr

From delhi they meet = distance travelled by train B =

$$35 \times \frac{25}{2} = 437 \frac{1}{2} \text{ km}$$

Ans

40 Two places P & Q are 162 km apart. Two trains starts from P & Q towards each other at same time and meet after 6 Hrs. Speed of one train is 8 km/Hr faster than other. find the speed of both the trains.

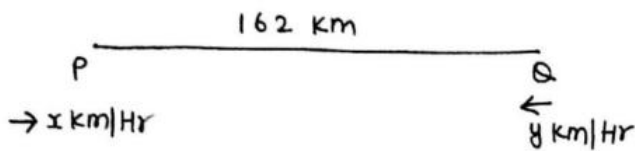

$$x + y = \frac{162}{6} = 27 \quad \left(\begin{array}{l} \text{Relative speed in opposite} \\ \text{direction will be added} \end{array} \right)$$

$$x + y = 27$$

$$x - y = 8$$

$$x = \frac{35}{2} \text{ km/Hr}$$

$$y = \frac{19}{2} \text{ km/Hr.}$$

41 A, B and C start from Delhi at 10am, 11am & 12:00 towards Goa & their speed are 3km/H, 4km/H & 5 km/H & After meeting on the way, B send back A to C with a message. At what time C will get the message?

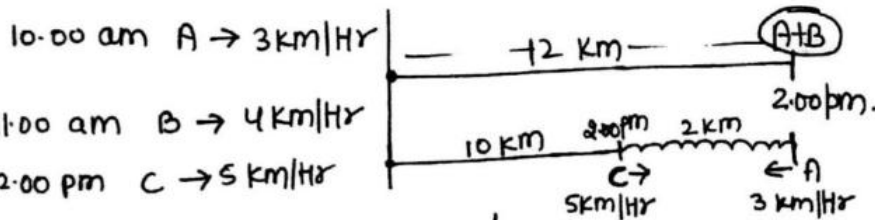

A in 1 Hr = 3 Km.

R.S of B = 1 km/Hr

Time of catch = $\frac{3}{1} = 3$ Hr after

ie 11:00am + 3Hr = 2:00 pm.
distance by B in 3Hr = $3 \times 4 = 12$ Km.

$$\begin{aligned} \text{Time of message blw A \& C} &= \frac{\text{distance blw them}}{\text{Relative speed}} \\ &= \frac{2}{8} = \frac{1}{4} \times 60 = 15 \text{ min} \end{aligned}$$

meet at 2:15 pm.

74
[42] Two trains starts at same time from delhi and jaipur towards each other with a speed of 80 km/Hr and 95 km/Hr. When they meet the faster train cover 180 km more distance than the other. find the distance b/w delhi & jaipur.



let they meet after x Hr
So distance travelled by 1st train in x Hr = $80x$
distance travelled by 2nd train in x Hr = $95x$
distance b/w Delhi & Jaipur = $80x + 95x = 175x$

Now: $95x - 80x = 180$ km

$$15x = 180$$

$$x = 12 \text{ Hr}$$

So they will meet after 12 Hr

$$\text{Distance b/w Delhi \& Jaipur} = 175 \times 12 = 2100 \text{ km}$$

(OR) let they meet after 1 Hr.

$$\text{Total distance} = 80 + 95 = 175 \text{ km}$$

$$\therefore 95 - 80 = 15 \text{ unit} \text{ ——— } 180$$
$$1 \text{ unit} \text{ ——— } 12$$

$$\therefore \text{ they meet after} = 1 \times 12 = 12 \text{ Hr}$$

$$\therefore \text{ Distance b/w Delhi \& Jaipur} = 175 \times 12 = 2100 \text{ km} \text{ Ans}$$

43 Two trains start at same time from two stations towards each other @ 20 km/hr and 25 km/hr. When they meet the faster train cover 80 km more distance than other. find the distance.



let they meet after x hr.

$$\text{Then distance} = 20x + 25x = 45x \text{ km.}$$

$$\therefore 25 - 20 = 5 \text{ km} \text{ ————— } 80$$

$$1 \text{ unit} \text{ ————— } 16 \text{ km.}$$

$$\therefore \text{They meet after} = 1 \times 16 = 16 \text{ hr.}$$

$$\text{distance} = 16 \times 45 = 720 \text{ km.}$$

44 Two stations A and B are 110 km apart. One train starts from A at 7:00 am and travel towards B. at 20 km/hr. Another train starts from B at 8:00 am towards A at 25 km/hr. At what time will they meet?

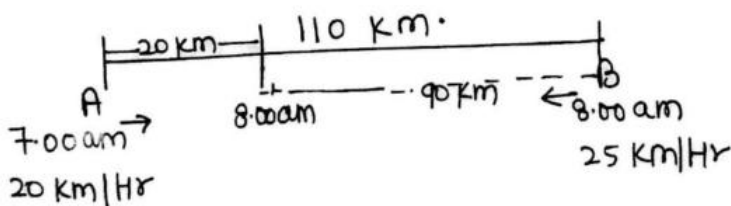

$$\text{Relative speed} = 20 + 25 = 45 \text{ km/hr.}$$

$$\text{Time of meet} = \frac{90}{45} = 2 \text{ hrs}$$

$$\Rightarrow 8:00 \text{ am} + 2 \text{ hr} = 10:00 \text{ am} \quad \underline{\underline{\text{Ans}}}$$

45 The distance b/w two stations A and B is 450 km. A 76
 train starts at 4 pm with 60 km/hr from A to B
 Another train starts from station B at 3:20 pm towards
 A with a speed of 80 km/hr. At what time will
 the both train meets.

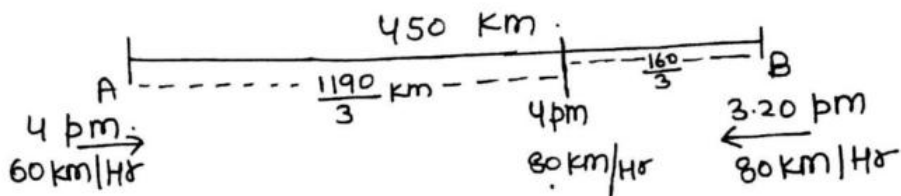

By Bin 40 min
 $\frac{40}{60} \times 80$
 $= \frac{160}{3}$ km.

Let meet after 1 hr then distance = $60 + 80 = 140$ km.

$$140 \text{ ————— } \frac{1190}{3}$$

$$1 \text{ unit ————— } \frac{1190}{3 \times 140} = \frac{17}{6} = 2 \frac{5}{6} \text{ Hr} = 2 \text{ Hr } 50 \text{ min}$$

meet after 2 Hr 50 min.

ie 4 pm + 2 Hr 50 min = ~~6:50 pm~~ 6:50 pm. Ans

OR

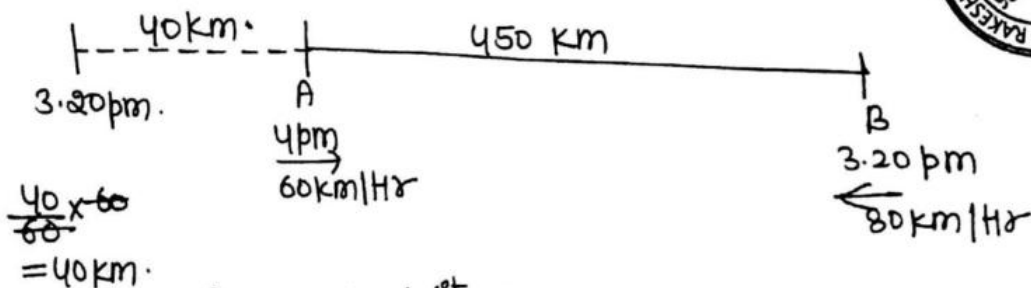

$\frac{40 \times 60}{60}$
 $= 40 \text{ km.}$

Assume that 1st train starts at 3:20.

Total distance = $40 + 450 = 490$

R.S = $60 + 80 = 140$

Time of meet = $\frac{490}{140} = 3.30 \text{ Hr.}$

$3:20 \text{ pm} + 3.30 \text{ Hr} = 6:50 \text{ pm}$

46 A train starts from Jaipur at 10:00 am and reach delhi at 3:00 pm. Another train starts from delhi at 11 am and reach jaipur at 6:00 pm. find the meeting time.

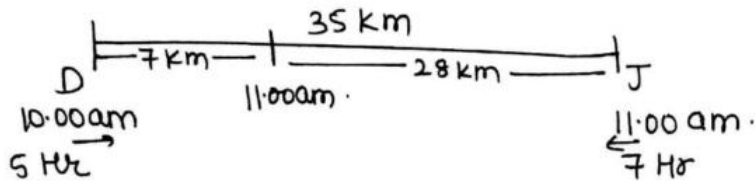

let distance = 35 km.

speed of D = 7 km/Hr

Speed of J = 5 km/Hr

$$\left(\begin{array}{l} \therefore \frac{35}{5} = 7 \\ \frac{35}{7} = 5 \end{array} \right)$$



$$\text{meeting Time} = \frac{28}{12} = 2\frac{1}{3} \text{ Hr} = 2 \text{ Hr } 20 \text{ min}$$

ie they will meet 11:00 + 2 Hr 20 min = 1:20 pm Ans

47 A train starts from station A at 7:00 am and reaches station B at 7:00 pm. Another train starts from station B at 9:00 am and reaches station A at 5 pm. find the time when they meet?

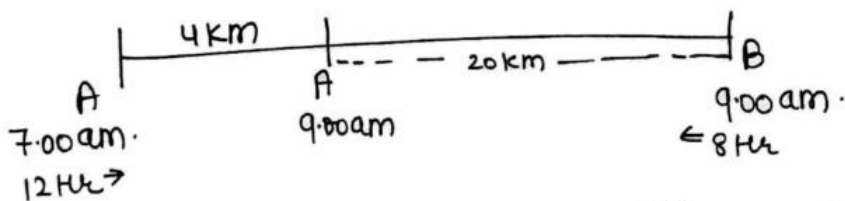

$$\text{Relative speed} = 2+3 = 5 \text{ km/Hr}$$

$$\text{meeting Time} = \frac{20}{5} = 4 \text{ Hr}$$

9:00am + 4 Hr = 1:00 pm Ans

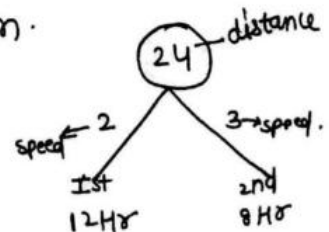

48] A train starts from Delhi at 8:00 am reached Agra at 10 am. Another train starts from Agra at 8:00 am & reached Delhi at 11:00 am. find the meeting time?

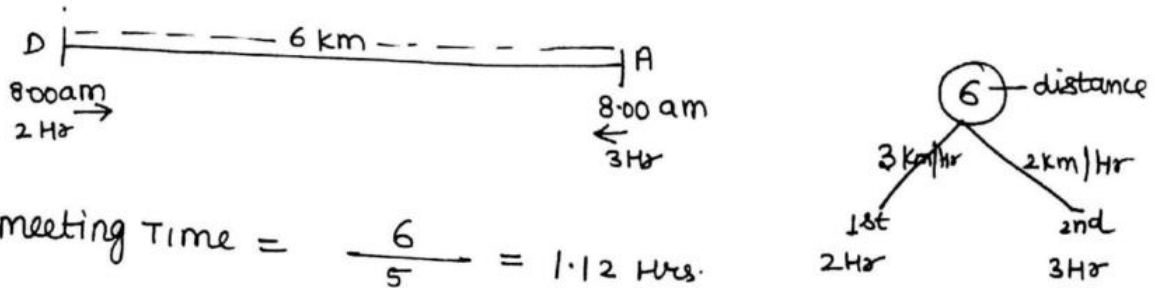

$$\text{meeting Time} = \frac{6}{5} = 1.2 \text{ Hrs.}$$

$$8:00 \text{ am} + 1.2$$

$$= 9:12 \text{ am} \quad \underline{\underline{\text{Ans}}}$$

49] By walking $\frac{6}{7}$ of his usual speed a man is 12 min late. find the usual time taken by him to cover that distance.

Speed
 $\frac{6}{7}$

Time
 $\frac{1}{6}$ unit — 12 min

usual time = $6 \times 12 = 72 \text{ min}$ Ans

50]

In covering a certain distance the ratio of speed of A & B is 3:4. A takes 30 min more than B to reach the destination. find the time taken by A to reach the destination?

	Speed	Time
A	3	4
B	4	3

1 unit $\xrightarrow{\times 30}$ 30 min

usual time taken by A = $4 \times 30 = 120$ min

& By B = $3 \times 30 = 90$ min.

51] A person running at $\frac{7}{11}$ of its usual speed reached a place in 22 hrs. How much time would he save had he run his normal speed?

Speed	Time
$\frac{7}{11}$	22 hrs
11	2
7	14

usual time = 14 hrs.
He would have save $\Rightarrow 22 - 14 = 8$ hrs.

52] A train starts from Delhi at 8:00 am. After 6 hrs there was a breakdown in the train, due to which it travels $\frac{2}{3}$ of its normal speed and hence becomes 40 mins late. If the breakdown would be 200 km further then it becomes 30 min late only. find the distance from Delhi to Agra?

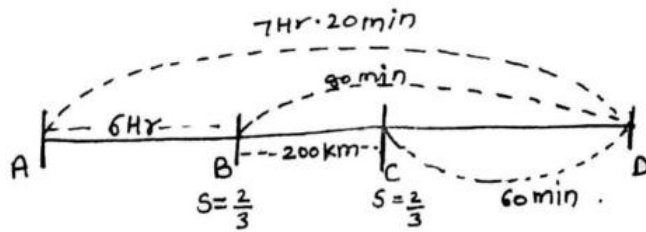

$6 \text{ Hr} + 80 \text{ min}$
 $= 7 \text{ Hr } 20 \text{ min}$

$T = \frac{3}{2} \rightarrow 40$
 $\downarrow \times 40$
 80 min
 (original time)

$T = \frac{3}{2} \rightarrow 30$
 $\downarrow \times 30$
 60
 (usual time)

From point B to D usual time of train = 80 min

\therefore time from A to D = 7 Hr 20 min

From C to D usual time = 60 min

\therefore B to C train takes $(80 - 60) = 20 \text{ min}$ and this distance is given 200 km.

$$T = \frac{20}{60} = \frac{1}{3} \text{ Hr}$$

$$\text{Speed} = \frac{200}{1/3} = 600 \text{ km/Hr}$$

Distance from A to D = $S \times T$

$$\begin{aligned}
 &= \frac{200}{600} \times \frac{22}{3} \\
 &= 4400 \text{ km } \underline{\underline{\text{Ans.}}}
 \end{aligned}$$

$$7 \frac{1}{3} = \frac{22}{3} \text{ Hr}$$

	A	B	
speed	4	: 3	speed $\propto \frac{1}{\text{Time}}$
Time	3	: 4	
if speed is $\frac{4}{3}$ then time is $\frac{3}{4}$.			

OR

S	T	
$\frac{2}{3}$	$\frac{3}{2}$) 1 unit — 10 min
		x 10 — 20 min

$T = \frac{20}{60} = \frac{1}{3}$ Hr

D = 200 km.

$S = \frac{200}{1/3} = 600$ km/Hr

CLASS

By Pardeep Chhoker

10

7206446517

53] A man starts from his home to his office with a certain speed but after 1 Hr he meets with an accident & resumes his journey after 1 Hr and becomes 1 Hr 36 min late due to reducing his speed to $\frac{5}{6}$. If the accident would occurred after 50 km then he will be late by 1 Hr 20 min. Find the distance from home to office ?

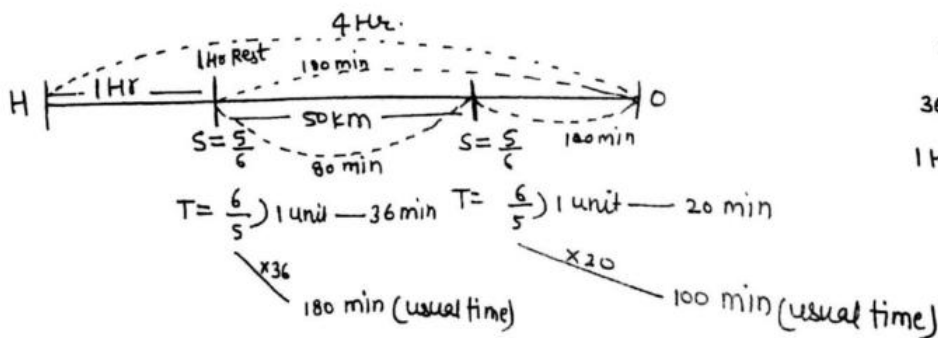

S	T
$\frac{5}{6}$	$\frac{6}{5}$) 1 unit — 16 min
	x 1/6 — 80 min

$D = 50 \text{ km}$

$T = \frac{80}{60} = \frac{4}{3} \text{ Hour}$

$S = \frac{50 \times 3}{4} = \frac{75}{2} \text{ km/hr}$

Distance b/w home to office = $\frac{75}{2} \times 4 = 150 \text{ km}$.

54) 2 guns were fired from same place at an interval of 28 mins. But a man sitting in the train approaching the place hears the 2nd firing 26 min after the 1st. if the speed of sound is 325 m/sec, find the speed of train?

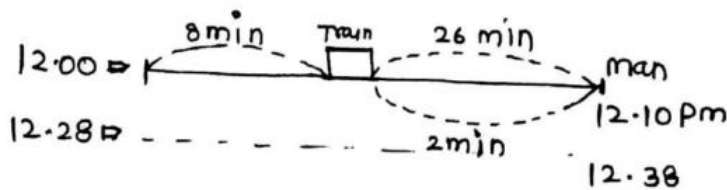

	Time	Speed
Train	26-13	$\xrightarrow{\times 25} 25 \text{ m/s}$
sound	2-1	$\xrightarrow{\times 25} 325 \text{ m/s}$

\therefore speed of Train = 25 m/s.

OR

28
26
जितनी देर बाद
man को सुनाई दी
वै man/train का Time होगा ।

2 जो diff होगा
वै sound का Time होगा

man/train	T	S
	26-13	1
sound	2-1	13

55 Two guns were fired from same place at an interval of 28 mins. But a man sitting in the train approaching going away from the place hears the 2nd firing 30 min after the 1st. If the speed of train is 20 km/hr find the speed of sound?

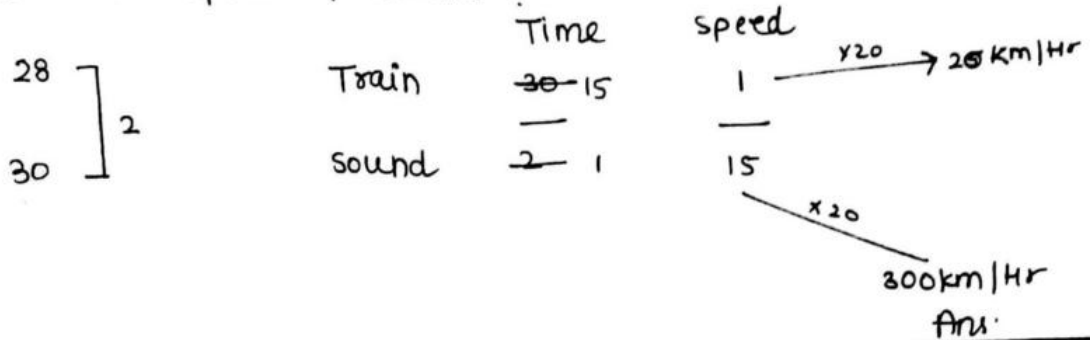

56 The buses are departed after every 20 min, but man going away from the bus depot after every 24 min get the buses. find the speed of buses if the speed of man is 30 km/hr.

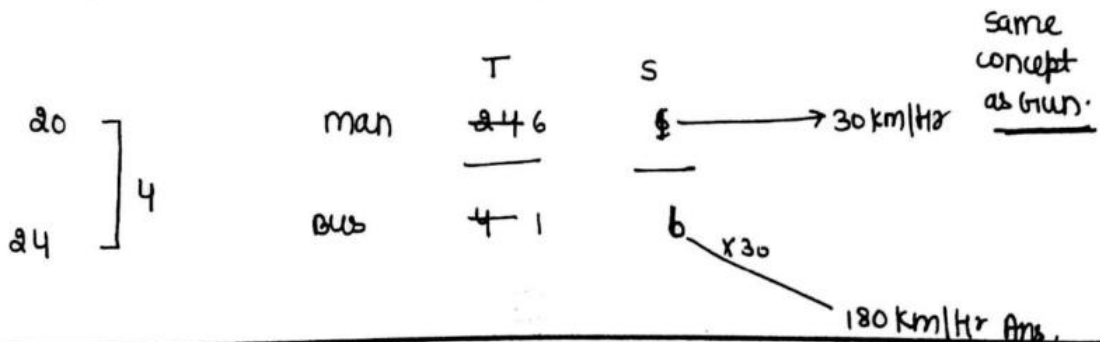

57 Two places A & B are 300 km apart, Mohit starts from city A at 8:24 am and an hour later Rohit starts from city A & after travelling for one hour he reaches at city C that Mohit had passed 40 min earlier. City C falls on the way from A to B. If they reach city B at same time, find their speed.

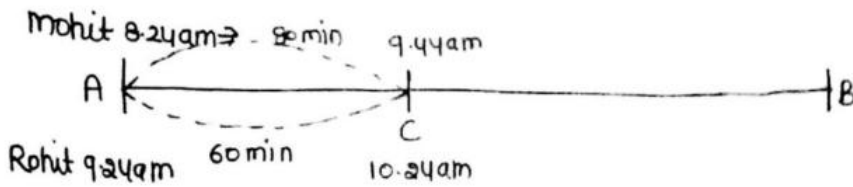

	T	S
Mohit	$\frac{80-4}{3x}$	$\frac{75}{4x}$
Rohit	$\frac{60-3}{4x}$	

$$\frac{100-300}{3x} - \frac{75-300}{4x} = 1$$

$$\frac{25}{x} = 1$$

$$x = 25$$

$$\text{Mohit} = 3 \times 25 = 75 \text{ km/Hr}$$

$$\text{Rohit} = 4 \times 25 = 100 \text{ km/Hr}$$



58] A boy starts from his home at a certain time with a certain speed to pick up his girlfriend from office at 5:00 pm. One day his girlfriend left the office at 3:00 pm and start walking to home with a speed of 40 km/Hr and meet the boy in the way who left his home at his usual time. They reached home 40 min earlier than their usual time. find the speed of boy.

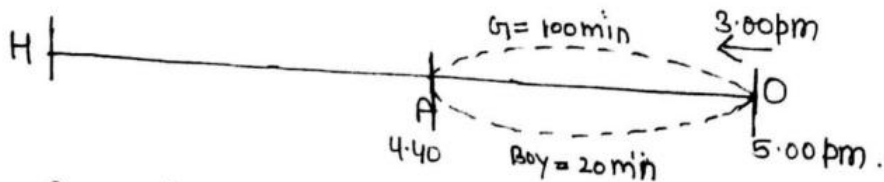

40 मिनट पहले पहुंच गए घर

क्योंकि आज Boy को A से O और O से A नहीं आना पड़ा
 \therefore A से O & O से A आने जाने में 40 min लगे (20+20)
 \therefore Hence they meet at 4:40 on the way.

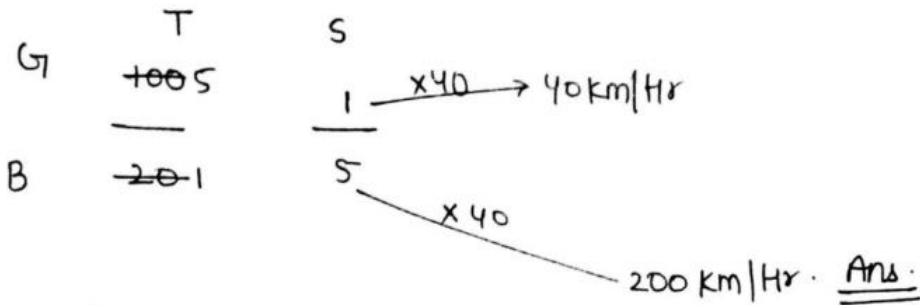

59] 2 places A and B are 60 km apart. 2 men P & Q start from A at same time & meet 1st time at a place 12 km from B & they have to reach at A after immediate return from B, if the speed of slower person is 48 km/Hr. find the diff of their speed?

If two or more objects starts at same time for a certain time then they travel the distance in the ratio of their speeds and vice-versa.

Eg:

A	B
5 km/Hr	4 km/Hr
3 Hr	3 Hr
+5 km	+2 km
5	4

Same ratio of speed & distance.



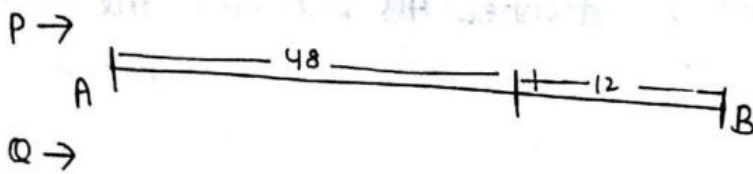

D. $\frac{P}{Q} = \frac{48 \text{ km}}{72 \text{ km}}$
 $\frac{2}{3}$

S: $\frac{2}{3}$
 $\times 24 \rightarrow 48 \text{ km/Hr}$ $\times 24 \rightarrow 72 \text{ km/Hr}$

diff. b/w their speed = 24 km/Hr.

60 Rohit and mohit starts at same time from A to B, after reaching their destination they turned to their starting point and they meet 1st time at 15 km from B. if the diff b/w their speed is 60 km/Hr then find the speed of faster if A & B are 60 km apart ?

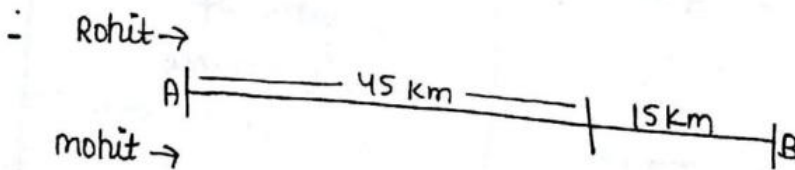

D. Rohit : mohit
 $45 \text{ km} : 75 \text{ km}$

S: $\frac{3}{5}$
 $\times 30 \rightarrow 90 \text{ km/Hr}$ $\times 30 \rightarrow 150 \text{ km/Hr}$

diff. = 60
 $\frac{60}{3} = 20$

Ans

61] A train approaches a tunnel AB, inside the tunnel a cat is located at a point ie $\frac{2}{5}$ the distance AB measure from the entrance. When the train whistle then cat run. If the cat decides to run towards A side the train catches the cat exactly at A. If the cat decides to run towards B side, the train catches the cat exactly at B. find ratio of speed of train & cat ?

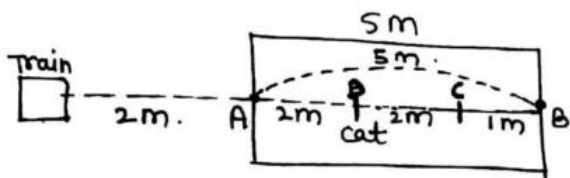

	Train	cat
Distance	5	1
speed	5	1



* cat is at point D. Train & A के बीच का distance 2m है. जब Train A point पर पहुंचेगी तो cat D से C पर पहुंच जायेगी. अब जितने time में train A से B 5m cover करती है उतने time में cat C से B 1m. \therefore same time पे चले हैं, same time पर पहुंचे हैं. so जो distance travel करेंगे अपनी speed की ratio में करेंगे।

62] A, B, C travels a distance of 1200 km from Delhi to Mumbai. B & C takes a car & A starts with tonga and after a certain distance C throws B from car. B takes a cycle and C returns to take A and finally they reach Mumbai at same time. If the speed of car is 50 km/hr and of cycle & tonga is 10 km/h each. find the total time of journey.

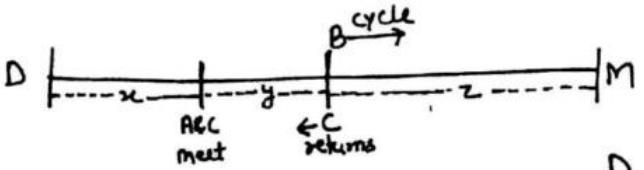

$$\frac{x+2y}{x} = \frac{50}{10}$$

$$\boxed{\frac{x}{y} = \frac{1}{2}}$$

\therefore जितने time में C (x+2y) distance cover करेगा उतने time में A (x) करेगा. \therefore दोनों जो distance cover करेंगे वो speed के ratio में करेंगे.

Dis. Speed

C $\frac{2y+z}{z} = \frac{50}{10}$

B

same case C और B का होगा.

$$\frac{z}{y} = \frac{1}{2}$$

X : Y : Z

1 : 2 : 1

1+2+1 = 4 → 1200 Km

1 unit → 300 Km.

Time taken =

$$\frac{300}{10} + \frac{900}{50}$$

= 48 Hrs. Ans.

$T = \frac{D}{S}$

#

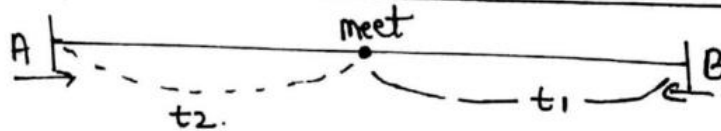

A & B starts walking towards each other
 After meeting A cover his distance in t_1
 time and B cover his distance in t_2 time
 Ratio of their speed is

$$\frac{A}{B} = \sqrt{\frac{t_2}{t_1}}$$

- 63] 2 men A & B start from Delhi & Agra at same time towards each other, after meeting on the way they cover their remaining journey in $7\frac{1}{9}$ Hr & $6\frac{1}{4}$ Hr respectively. find the slower speed if faster speed is 40 km more than slower?

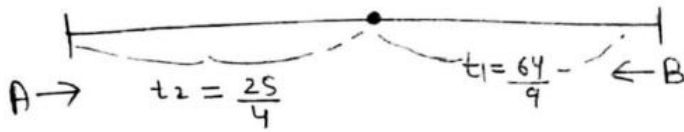

$$\frac{A}{B} = \frac{\sqrt{\frac{25}{4}}}{\sqrt{\frac{64}{9}}} = \sqrt{\frac{25}{4} \times \frac{9}{64}} = \frac{15}{16}$$

$$\frac{A}{B} = \frac{15}{16} \text{) 1 unit } \times 40 = 40 \text{ km}$$

$$A = 15 \times 40 = 600 \text{ km/hr}$$

$$B = 16 \times 40 = 640 \text{ km/hr}$$

64] A distance of 600 km is to be covered in 2 parts. In 1st phase 120 km is travelled by train and rest by car and it took total of 8 hr, but if 200 km is covered by train and rest by car it takes 20 min more. find the avg speed of car and train?

$$\frac{120}{T} + \frac{480}{C} = 8 \text{ --- (i)}$$

$$\frac{200}{T} + \frac{400}{C} = 8\frac{1}{3} \text{ --- (ii)}$$

Multiply (i) by 5 and (ii) by 3.

$$\frac{600}{T} + \frac{2400}{C} = 40$$

$$\frac{600}{T} + \frac{1200}{C} = 25$$

$$\frac{80 \times 1200}{C} = 15$$

$$C = 80 \text{ km/hr}$$

Put in (i)

$$\frac{120}{T} + \frac{480}{80} = 8$$

$$\frac{120}{T} = 8 - 6 = 2$$

$$T = \frac{120}{2} = 60$$

$$T = 60 \text{ km/hr}$$

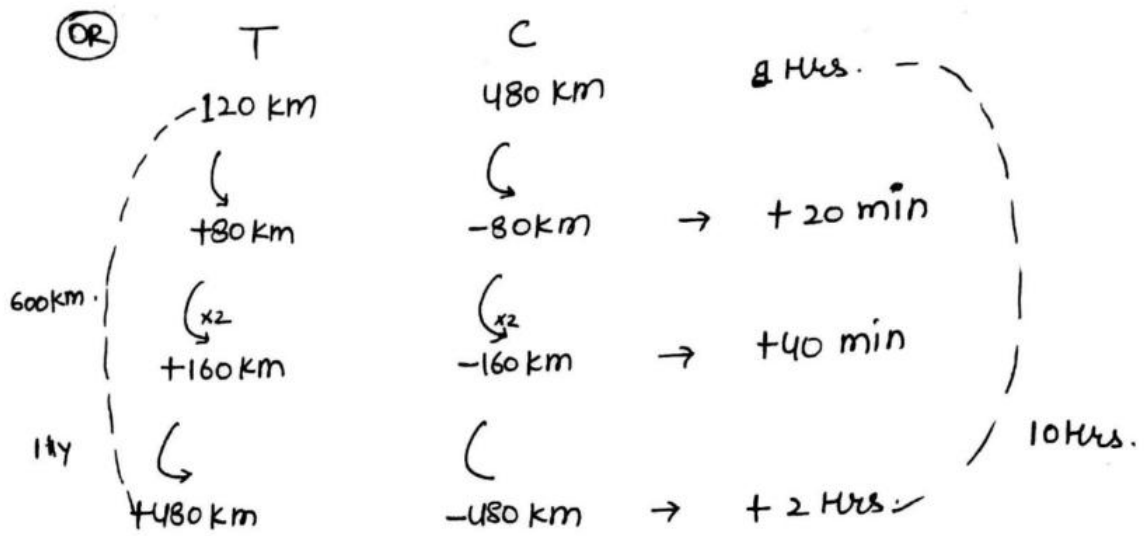

speed of Train = $\frac{600}{10} = 60 \text{ km/Hr.}$

⇒

T	C	
$\frac{120 \text{ km}}{60}$	$\frac{480 \text{ km}}{6}$	8 Hr
= 2 Hr	80 km/Hr.	
	↓	
	Car speed.	<u>Ans.</u>

CLASS

11.

By Pardeep Chhoker

7206446517

65] A man takes 6.30 Hrs in walking to a certain distance and riding back on horse. If he rides both sides on horse he would have saved 2 Hrs 10 min. How much time does he take on walking both sides.

$$W + R = 6.30$$

$$R + R = 4.20$$

↓ ↓

$$2.10 \quad 2.10$$

$$50. \quad W + R = 6.30$$

↓
2.10

$$W = 4.20$$

$$W + W = 4.20 + 4.20 = 8.40 \text{ Hrs. } \underline{\underline{\text{Ans}}}$$



66] Without any stoppage a person travel a certain distance at an avg speed of 42 km/Hr and with stoppage it travel the same distance with 28 km/Hr avg speed. Find how many min per hour does he stop ?

$$\frac{42-28}{42} \times 60$$

$$\frac{14}{42} \times 60 = 20$$

$$= 20 \text{ min/hr.}$$

$$\left(\frac{\text{Faster speed} - \text{Slower speed}}{\text{Faster speed}} \times 60 \right) \text{ min/hr}$$

67] Excluding stoppage the speed of bus is 54 km/hr
Including stoppage it is 45 km/hr. How many
min does the bus stops per hour.

$$\frac{54-45}{54} \times 60$$

$$\frac{9}{54} \times 60 = 10 \text{ min/hr. } \underline{\text{Ans}}$$

68] A train covers a distance of 36 km with speed
of 12 km/hr, if it stops 12 min after every 1 km.
find the total time covered in distance by the
train?

$$\frac{36}{12} = 3 \text{ hr.}$$

He stops 12 min after every 1 km.

∴ He stops 35 times.

$$\frac{35 \times 12}{60} = 7 \text{ hrs he stops.}$$

$$\text{Total time} = 3 + 7 = 10 \text{ hrs.}$$



69] An express train travelled at 100 km/hr stopping
for 3 min after every 75 km and a local train
travelled at 50 km/hr stopping for 1 min after every
25 km. If both train starts together then how many
kms did the local train travel in the time it
took the express train to travel 600 km?

Express Train

$$\frac{600}{100} = 6 \text{ Hr.}$$

Stoppage Time = $\frac{600}{75} = 7$ times (8th time तो destination पर पहुंच जास्गी)

$$7 \text{ times} \times 3 \text{ min} = 21 \text{ min.}$$

Total time taken by Express train = 6 Hr 21 min

Slower Train

50 km/Hr & stops 2 min in every Hr.

$$6 \text{ Hr} + 6 \times 2 (12 \text{ min})$$



300 km (in 6 Hr 12 min)



Time left = 9 min $\Rightarrow \frac{50 \times \frac{9}{60}^3}{2} = 7.5 \text{ Km.}$

Total distance covered by slower train = 307.5 Km.

70 Speed of a steam engine is 24 km/Hr without any wagon. The decrease in speed of engine is directly proportional to the square root of no. of wagons attached. if 4 wagons are attached with engine speed becomes 20 km/Hr. find the max. no. of wagons which are attached with engine so that engine can carry.

$$\text{Decrease} \propto \sqrt{w}$$

$$D = K \sqrt{w}$$

$$24 - 20 = K \sqrt{4}$$

$$2 \times 4 = K \times 2$$

$$\boxed{K = 2}$$

$$\therefore D = 2\sqrt{w}$$

Train की speed zero करने के लिए 24 decrease करेंगे

$$12 - 24 = 2\sqrt{w}$$

$$w = 144$$

144 wagon पे speed zero हो जास्गी means Train 143 wagon ले जा सकती हैं।

143 wagon Ans

71) The distance b/w 2 stations X and Y is 650 km. if 2 trains start together at same time from both stations towards each other and meet after 10 hrs but if one train is started 4 hrs 20 min after the first then they meet after 8 hrs. find the speed of trains.

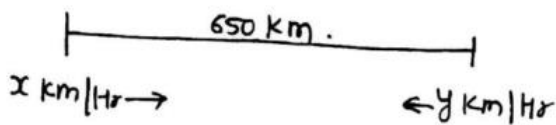

meeting time = 10 hrs.

$$\therefore \text{Relative speed } (x+y) = \frac{650}{10} = 65 \text{ km/hr.}$$

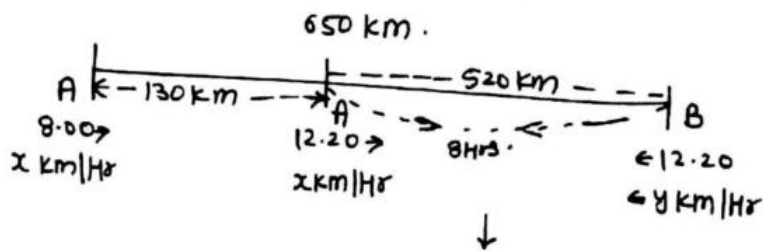

meet time = 8 hrs.

$$D = S \times T = 65 \times 8 = 520 \text{ km.}$$

speed of A in covering 130 km in 4 hrs 20 min

$$S = \frac{130}{\frac{13}{3}} \times 3 = 30 \text{ km/hr.}$$

$$4 \frac{20}{60} = \frac{13}{3} \text{ hr.}$$

Speed of Train A (x km/hr) = 30 km/hr.

Speed of Train B (y km/hr) = 65 - 30 = 35 km/hr.

Ans

72 A person travel 120 km by a steamer, 460 km by train & 60 km by Horse. The total journey took 13 Hr 30 min. If the rate of the train is 3 times that of horse and 1.5 times that of steamer. Find the speed of train.

$$\begin{array}{ccc} T & H & S \\ 3x & : & 1x & : & 2x \end{array}$$

$$\frac{120}{3x} + \frac{60}{x} + \frac{460}{2x} = \frac{27}{2}$$

$$\frac{270}{x} = \frac{27}{2}$$

$$\boxed{x=20}$$

$$\text{Speed of Train} = 3x = 3 \times 20 = 60 \text{ km/Hr.}$$

73 A man travel 360 km in 4 hrs partly by air and partly by train. If he had travelled all the way by air then he would have arrived 2 hrs earlier at his destination and save $\frac{4}{5}$ of the time he was in train. Find the distance travelled by air and train separately?

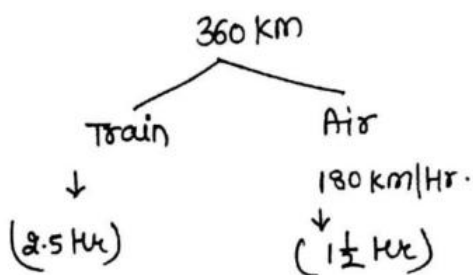

$$\text{By Air} = 180 \times \frac{3}{2} = 270 \text{ km.}$$

$$\text{By Train} = 360 - 270 = 90 \text{ km}$$

Ans.

$$T + A = 4 \text{ hrs}$$

$$A = 4 - 2 = 2 \text{ hrs.}$$

$$\text{Speed in Air} = \frac{360 \text{ km}}{2 \text{ hrs}} = 180 \text{ km/Hr.}$$

$$* \text{ Train time} = t \text{ hour}$$

$$t \times \frac{4}{5} = 2$$

$$t = 2.5 \text{ Hr.}$$

$$\text{Air} = 4 - 2.5 = 1.5 \text{ Hr.}$$

2 Hr जल्दी पहुंचा है तो Train के time का $\frac{4}{5}$ save किया है।

74 From two places 60 km apart A & B starts towards each other at same time and meet each other after 6 hrs. if A travel $\frac{2}{3}$ of his speed and B travel with double of his speed then they would have met after 5 hrs. find the speed of A.

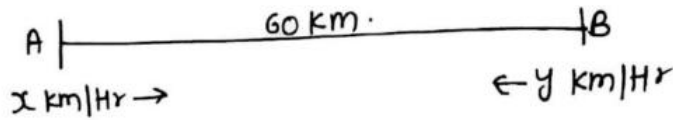

$$x + y = 10$$

$$\left(\frac{2x}{3} + 2y\right) = 12$$

$$\Rightarrow \begin{array}{r} x + 3y = 18 \\ x + y = 10 \end{array}$$

$$\hline 2y = 8$$

$$2y = 8$$

$$\boxed{y = 4 \text{ km/Hr}}$$

$$x = 10 - 4 = 6.$$

$$\therefore \boxed{x = 6 \text{ km/Hr}}$$

$$\begin{aligned} R \cdot S &= \frac{d}{t} \\ &= \frac{60}{6} \\ &= 10 \end{aligned}$$

$$* \frac{60}{5} = 12$$

75 A man travel from A to B at 20 km/Hr. and come back from B to A at 30 km/Hr. find the avg. speed of the whole journey.

$$\text{Avg speed} = \frac{\text{Total distance}}{\text{Total time.}}$$

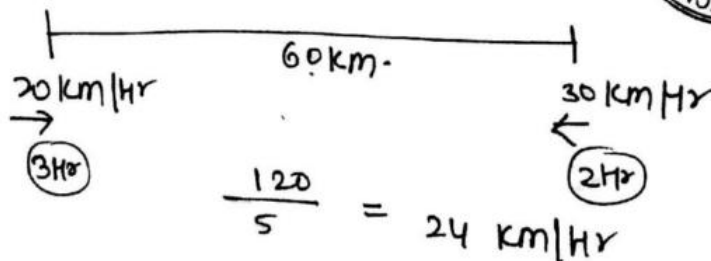

- 76] A man travel from A to B at 20 km/Hr and he come back from B to A at 30 km/Hr. and he again travel from A to B at 40 km/Hr. find the avg speed of the whole journey?

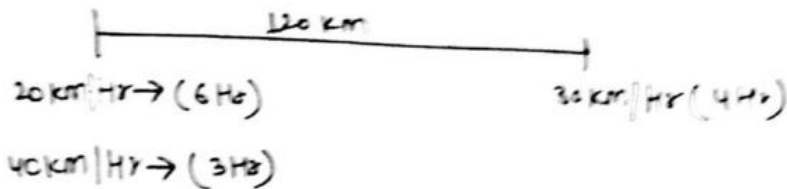

Avg speed = $\frac{360}{13}$ km/Hr.



$120 + 120 + 120 = 360$

- 77] Four cities A, B, C & D are on the corners of a square. And the side of the square is 100 km. A man travel from A to B at 10 km/Hr, B to C @ 20 km/Hr, C to D @ 30 km/Hr and D to A @ 40 km/Hr. find the avg speed of the whole journey.

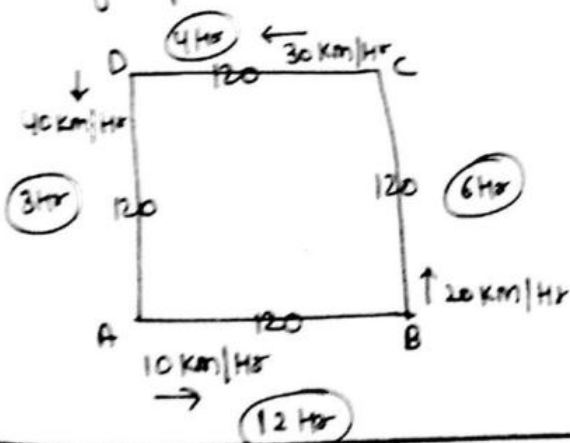

Avg. speed में सभी दिशा से कोई भी distance ले सकते हैं।

$\frac{120 \times 4}{25} = \frac{96}{5}$ km/Hr.

- 78] A man travel from A to B a 39 km distance with a speed of 15 km/Hr and he travel from B to C 52 km distance with a speed of 18 km/Hr. find the avg speed of whole journey?

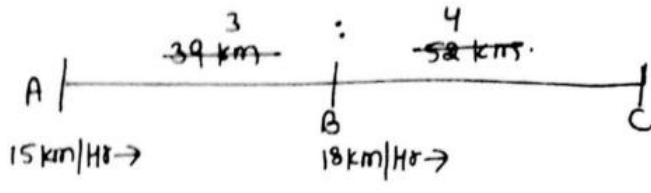

कोई भी distance ले सकते हैं but ratio same आना चाहिए distance का

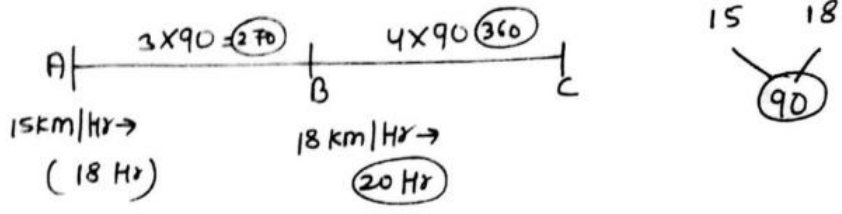

$$\text{Avg speed} = \frac{270 + 360}{18 + 20} = \frac{630}{38} \text{ km/hr}$$

79 A man travel from A to B at a speed of 29 km/hr in 29 min. and he travel a distance from B to C with a speed of 39 km/hr in 29 min. find the avg speed of whole journey.

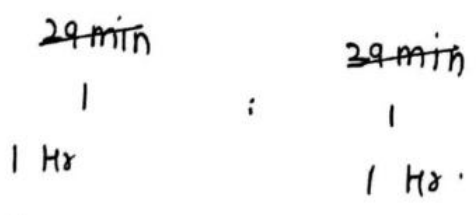
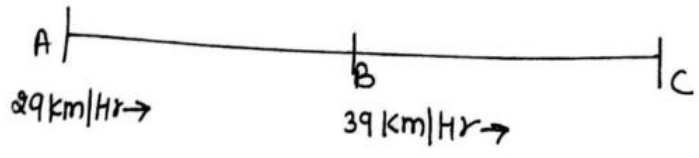

कोई भी Time ले सकते हैं But original वाले time का जो ratio है वही हमारा होना चाहिए.

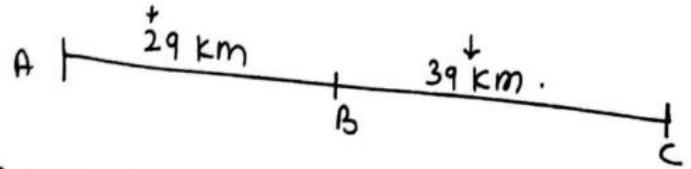

$$\text{Avg speed} = \frac{29 + 39}{1 + 1} = \frac{68}{2} = 34 \text{ km/hr}$$

80 A gives B a start of 5 sec. in 1000 m race. But 99
 both finish the race at same time. find the time
 taken by A to finish the race. if speed of B is
 5m/sec.

$$B = \frac{1000}{5} = 200 \text{ sec.}$$

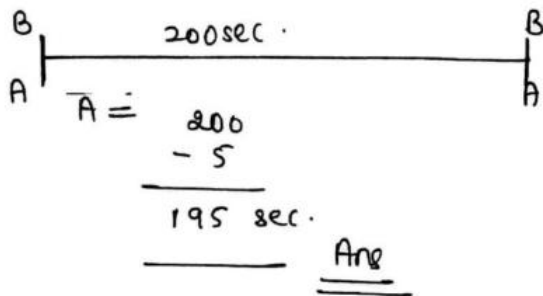

81 A is $1\frac{2}{3}$ times faster than B. A gives 60 m start to B
 in a race. find the length of race if both finish
 the race at same time.

	A	:	B
Speed →	$5x$:	$3x$
distance	$5x$:	$3x$
	$2x \rightarrow 60$		
	$x = 30$		

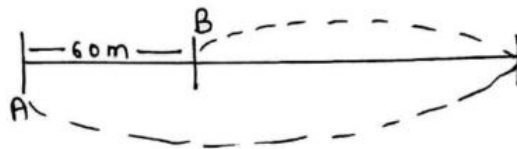

Race track = $5x = 150 \text{ mt.}$

82 In a 1000 m race A gives a start of 100 m to B &
 150 m to C. How much start B can give to C in
 a race of 1000 m.

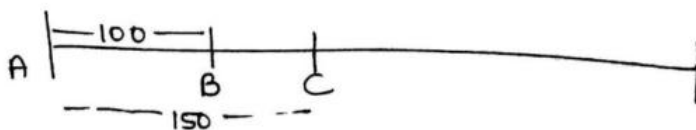

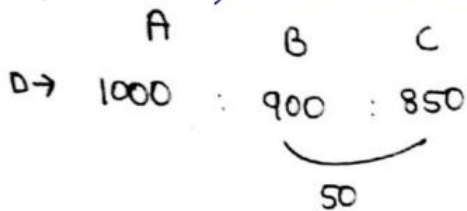

if 900 mt race B to C a start of — 50 mt
 " " " " — $\frac{50}{900}$
 1000 mt " " " = $\frac{50}{900} \times 1000$
 = $55 \frac{5}{9}$ m Ans

83] A can finish a race in 3 min, 10 sec. while B can finish the same race in 3 min 20 sec. By what distance A will defeat B in a race of 1000 m.

	A	:	B
Time	190		200
Speed	20	:	19
	$\times 50 \downarrow$		$\downarrow \times 50$
	1000		950
	50 mt. <u>Ans.</u>		

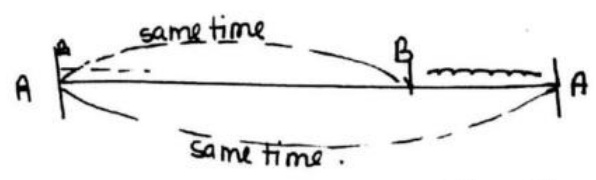

Same Time पर चले हैं और same time के लिए दौड़े हैं तो speed के ratio में distance cover करेंगे.

84] In a 100 m race A runs at a speed of 9 km/hr. He gives a start of 10 m to B and still defeat him by 10 sec. find speed of B.

$9 \text{ km/hr} \times \frac{5}{18} = \frac{5}{2} \text{ m/s}$
 $A = \frac{100 \times 2}{5} = 40 \text{ sec.}$

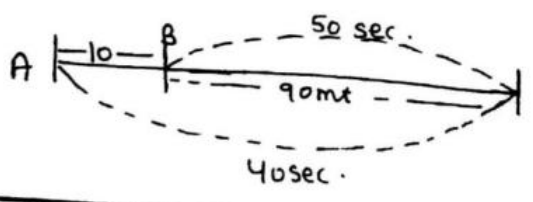

B cover 90 mt in 50 sec.
 $\text{speed}_B = \frac{90}{50}$
 $= \frac{9}{5} \text{ m/s.}$

85] In a 100 m race A runs at a speed of 5 km/hr. He gives a start of 8 m to B and still defeat him by 8 sec. find speed of B ?

$$A = 5 \times \frac{5}{18} = \frac{25}{18} \text{ m/s.}$$

$$A = \frac{4}{\frac{100 \times 18}{25}} = 7.2 \text{ sec.}$$

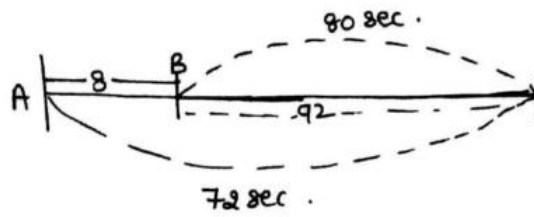

B will cover 92 m in 90 sec.

$$S = \frac{92}{90} = \frac{23}{20} \text{ m/sec. } \underline{\underline{\text{Ans.}}}$$

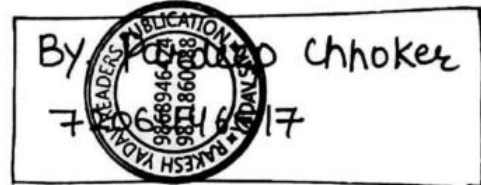

#

→ Boat (B)

→ water (W)

Relative Speed = $B+W$

→ Boat

← water

Relative Speed = $B-W$

Downstream = $(B+W)$

Upstream = $(B-W)$

- ① A boat row down a river at 21 km/Hr and row up the river at 9 km/Hr. What is the velocity of the stream.

$$B + W = 21$$

$$B - W = 9$$

$$2B = 30$$

$$B = 15 \text{ km/Hr}$$

$$\text{water} = 21 - 15 = 6 \text{ km/Hr. } \underline{\text{Ans.}}$$



- ② A swimmer can swim downstream at 14 km/Hr and upstream (Us) at 6 km/Hr. Find the speed of swimmer in still water?

$$S + w = 14$$

$$S - w = 6$$

$$2S = 20$$

$$S = 10 \text{ km/Hr } \underline{\text{Ans}}$$

- 3] The speed of a boatman in the direction of stream 103 is 15 km/hr. while the speed of stream is 1.5 km/hr. What is the speed of boatmen against the stream.

$$B + W = 15$$

$$\downarrow \\ 1.5$$

$$B = 13.5 \text{ km/hr.}$$

Upstream $\Rightarrow B - W$

$$\Rightarrow 13.5 - 1.5 = 12 \text{ km/hr.}$$

-
- 4] A swimmer swims a distance of 36 km in 6 hrs downstream. and a distance of 40 km upstream in 8 hrs. find the speed of swimmer in still water ?

$$B + W = 6$$

$$B - W = 5$$

$$B = 5.5 \text{ km/hr} \text{ --- Ans}$$

$$W = 0.5 \text{ km/hr}$$

$$S = \frac{36}{6} = 6$$

$$S = \frac{40}{8} = 5$$



-
- 5] In 3 hrs a swimmer can row 21 km down stream and 15 km against the stream in same time. find the speed of stream ?

$$B + W = 7$$

$$B - W = 5$$

$$B = 6 \text{ km/hr}$$

$$W = 1 \text{ km/hr} \text{ --- Ans.}$$

$$\frac{21}{3} = 7$$

$$\frac{15}{3} = 5$$

- 6] Two places are 108 km apart. Two boats starts from both places at same time towards each other. If one boat is going downstream then other one is going to upstream. After how much time will they meet each other if their speeds are 12 km/hr & 15 km/hr.

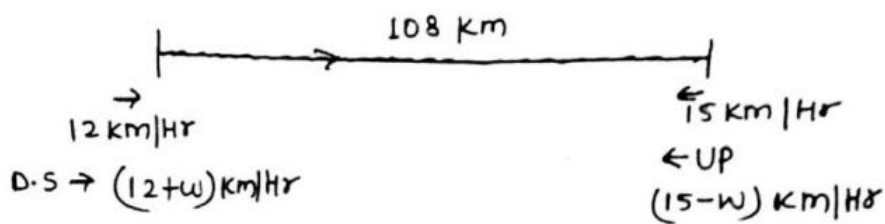

$$\text{meeting time} = \frac{\text{distance}}{\text{Relative speed}}$$

$$\text{Relative speed} = 12+w + 15-w = 27$$

$$\text{meet time} = \frac{108}{27} = 4 \text{ hrs.}$$

- 7] A boat takes double of time taken by it to go downstream while coming in upstream. If speed of water is 3 km/hr. find the speed of boat.

$$\frac{D}{B+3} \times 2 = \frac{D}{B-3}$$

$$T = \frac{D}{S}$$

$$2B-6 = B+3$$

$$B = 9 \text{ km/hr Ans.}$$

- 8] A man can row $9\frac{1}{3}$ km/hr in still water & he finds that it takes him thrice as much time to row upstream as to row downstream. find speed of water/current.

$$\frac{D}{\left(\frac{28}{3} + w\right)} \times 3 = \frac{D}{\left(\frac{28}{3} - w\right)}$$

$$w = \frac{14}{3} \text{ km/Hr.}$$

OR

$$D.S = 1 \text{ Hr.}$$

$$U.P = 3 \text{ Hr.}$$

$$\left(\frac{28}{3} + w\right) \times 1 = \left(\frac{28}{3} - w\right) \times 3$$

$$w = \frac{14}{3} \text{ km/Hr.}$$

$$D.S \text{ Relative speed} = \frac{28}{3} + w \quad 105$$

$$U.P \text{ Relative speed} = \frac{28}{3} - w$$

$$T = \frac{D}{S}$$

$$D = ST$$

यहाँ distance को equate किया है।

9] A boatman can bow certain distance D.S in 2Hrs and U.P the same distance in 3 Hrs. If the stream flows at the rate of 4 km/Hr. find the speed of boat in still water ?

$$D.S = 2 \text{ Hr.}$$

$$U.P = 3 \text{ Hr.}$$

$$D.S \text{ speed} = B + 4$$

$$U.P \text{ speed} = B - 4$$

$$(B + 4) \times 2 = (B - 4) \times 3$$

$$2B + 8 = 3B - 12$$

$$B = 20 \text{ km/Hr.}$$

10] A boatman goes 6 km upstream and back again to the starting point in 2 hrs. If the speed of water is 4 km/Hr. find the speed of boat ?

$$\frac{6}{B + 4} + \frac{6}{B - 4} = 2$$

either solve or pick from options.

option c satisfies.

$$B = 8 \text{ km/Hr. } \underline{\text{Ans.}}$$

$$T = \frac{D}{S}$$

A) 6.5 km/Hr

B) 7.5 km/Hr

C) 8 km/Hr

D) 8.5 km/Hr.

- 11 A boat travels ~~8 km~~^{4 km} A to P and downstream P to A in 3 hrs. The distance b/w P to A is 4 km, the speed of water is 1 km/hr. Find the speed of boat in still water?

$$\frac{4}{B+1} + \frac{4}{B-1} = 3 \text{ Hr}$$

option D satisfies.

$$B = 3 \text{ km/hr.}$$

A) 4.5 km/H.

B) 5.2 km/H

C) 2.5 km/H

D) 3 km/H

- 12 Priyanka was travelling in her boat. Suddenly a wind blows her hat off & started floating back downstream. The boat continued to travel upstream for 12 more minutes before priyanka realised her hat had fallen off. She turned back downstream and she caught up the hat as soon as it reached the starting point. If her hat flew off exactly 3 km from where she started find the speed of water?

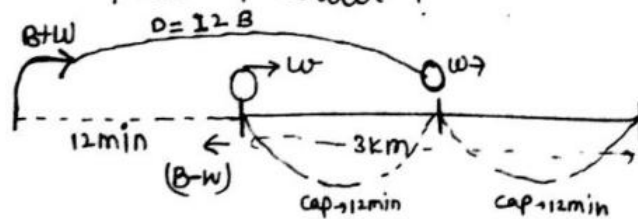

$$\text{Relative speed of boat \& cap} = B - W + W = B.$$

$$B \times \frac{12}{60} = \cancel{0.2} B. \quad D = ST \Rightarrow B \times 12 = 12 B.$$

$$\text{R.s in same dir'n} = B + W - W = B.$$

$$\text{Time of catch} = \frac{D}{S} = \frac{12B}{B} = 12 \text{ min.}$$

Total time taken by cap to flow back = $12+12 = 24 \text{ min}$

$$D = 3 \text{ km}$$

$$T = \frac{24}{60} = \frac{2}{5}$$

$$S = \frac{D}{T} = \frac{3}{\frac{2}{5}} = 7\frac{1}{2} \text{ km/Hr. } \underline{\text{Ans}}$$

OR

Boat की speed
नहीं निकलेगी ।

$$D = 3 \text{ km}$$

Time = double ले लो = $2 \times 12 = 24 \text{ min} = \frac{2}{5} \text{ Hr.}$

$$S = \frac{3}{\frac{2}{5}} = 7\frac{1}{2} \text{ km/Hr. } \underline{\text{Ans}}$$

13 A boatman goes 39 km D.S and 25 km U.S & takes 8 Hr. While it takes 10 Hrs to go 52 km D.S and 30 km U.S. find the speed of boat ?

$$\frac{39}{B+W} + \frac{25}{B-W} = 8 \text{ --- (i)}$$

$$\frac{52}{B+W} + \frac{30}{B-W} = 10 \text{ --- (ii)}$$

Multiply (i) by 6 and (ii) by 5

$$\frac{234}{B+W} + \frac{150}{B-W} = 48$$

$$\frac{260}{B+W} + \frac{150}{B-W} = 50$$

$$\frac{26}{B+W} = 2$$

$$\boxed{B+W = 13}$$

put $B+W=13$ in (i)

$$3 + \frac{25}{B-W} = 8$$

$$\frac{25}{B-W} = 5$$

$$\boxed{B-W = 5}$$

$$B+W = 13$$

$$B-W = 5$$

$$B = 9 \text{ km/Hr}$$

$$W = 4 \text{ km/Hr}$$

OR You can pick value from options or assume yourself to satisfy the eqn.

14 A boatman goes 24 km D.S and 36 km U.S in 9 hrs. While it takes $8\frac{1}{2}$ hrs to go 36 km D.S and 24 km U.S. find the speed of boat ?

$$\frac{24}{B+W} \times 3 + \frac{36}{B-W} \times 3 = 9 \times 3 \Rightarrow \frac{72}{B+W} + \frac{108}{B-W} = 27$$

$$\frac{36 \times 2}{B+W} + \frac{24 \times 2}{B-W} = \frac{17}{2} \times 2 \Rightarrow \frac{72}{B+W} + \frac{48}{B-W} = 17$$

$$\frac{60}{B-W} = 10$$

Put $(B-W) = 6$ in eq(1)

$B-W = 6$

$$\frac{24}{B+W} + 6 = 9$$

$$\frac{24}{B+W} = 3$$

$B+W = 8$

$$B+W = 8$$

$$B-W = 6$$

$$B = 7 \text{ km/hr}$$

$$W = 1 \text{ km/hr}$$

OR Assume values to satisfy the eqn.

15 A ship is 77 km from the shore, springs a leak which admits $2\frac{1}{4}$ ton of water in every $5\frac{1}{2}$ min. An outlet tank can through out 12 tons of water per hour. find at what speed it should move such that when it begins to sink a rescue ship moves with 6 km/hr escapes the passengers of the ship if 69 ton of water is enough to sink ?

$$\frac{11}{2} \text{ min} \text{ ————— } \frac{9}{4} \text{ ton}$$

$$1 \text{ min} \text{ ————— } \frac{\frac{9}{4}}{11/2} = \frac{9}{22} \text{ ton}$$

$$60 \text{ min} \text{ ————— } \frac{9}{22} \times \frac{30}{60} = \frac{270}{11} \text{ ton/hr enters into ship}$$

$$\Rightarrow \frac{270}{11} - (12) \rightarrow \text{outlet pipe.}$$

$$\frac{270-132}{11} = \frac{138}{11} \text{ ton/hr filling in ship per hour.}$$

$$\underline{\text{Now}} \quad \frac{69}{138/11} = \frac{69 \times 11}{138} = \frac{11}{2} \text{ Hr} \rightarrow \text{ship will sink in } \frac{11}{2} \text{ Hr.}$$

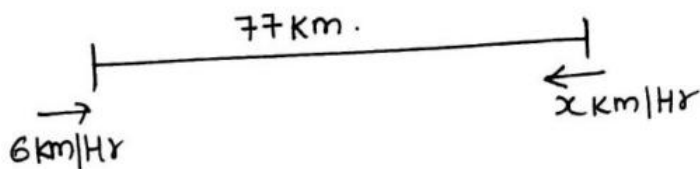

$$(6+x) \times \frac{11}{2} = 77$$

$$6+x = 14$$

$$x = 8 \text{ km/Hr.} \quad \underline{\underline{\text{Ans.}}}$$

By Pardeep Chhoker

7206446517

CLASS
13

PERCENTAGE

111

$$\frac{1}{2} = 50\%$$

$$\frac{1}{3} = 33\frac{1}{3}\%$$

$$\frac{1}{4} = 25\%$$

$$\frac{1}{5} = 20\%$$

$$\frac{1}{6} = 16\frac{2}{3}\%$$

$$\frac{1}{7} = 14\frac{2}{7}\%$$

$$\frac{1}{8} = 12\frac{1}{2}\%$$

$$\frac{1}{9} = 11\frac{1}{9}\%$$

$$\frac{1}{10} = 10\%$$

$$\frac{1}{11} = 9\frac{1}{11}\%$$

$$\frac{1}{12} = 8\frac{1}{3}\%$$

$$\frac{1}{13} = 7\frac{6}{13}\%$$

$$\frac{1}{14} = 7\frac{1}{7}\%$$

$$\frac{1}{15} = 6\frac{2}{3}\%$$

$$\frac{1}{16} = 6\frac{1}{4}\%$$

$$\frac{1}{17} = 5\frac{15}{17}\%$$

$$\frac{1}{18} = 5\frac{5}{9}\%$$

$$\frac{1}{19} = 5\frac{5}{19}\%$$

$$\frac{1}{20} = 5\%$$

$$\frac{1}{24} = 4\frac{1}{6}\%$$

$$\frac{1}{25} = 4\%$$

$$\frac{1}{40} = 2\frac{1}{2}\%$$

$$\frac{3}{8} = 37\frac{1}{2}\%$$

$$\frac{5}{8} = 62\frac{1}{2}\%$$

$$\frac{4}{7} = 57\frac{1}{7}\%$$

$$\frac{5}{7} = 71\frac{3}{7}\%$$

$$\oplus \frac{1}{3} = 33\frac{1}{3}\%$$

$$\frac{2}{3} = 66\frac{2}{3}\%$$

$$\frac{1}{5} = 20\%$$

$$\frac{4}{5} = 80\%$$

$$\frac{1}{4} = 25\%$$

$$\frac{3}{4} = 75\%$$

$$\frac{1}{11} = 9\frac{1}{11}\%$$

$$\frac{5}{11} = 45\frac{5}{11}\%$$

$$\frac{7}{11} = 63\frac{7}{11}\%$$

$$\frac{10}{11} = 90\frac{10}{11}\%$$

$$\frac{1}{9} = 11\frac{1}{9}\%$$

$$\frac{4}{9} = 44\frac{4}{9}\%$$

$$\frac{7}{9} = 77\frac{7}{9}\%$$

$$\frac{1}{12} = 8\frac{1}{3}\%$$

$$\frac{5}{12} = 8\frac{1}{3} \times 5$$

$$= 40\frac{5}{3}$$

$$\Rightarrow 41\frac{2}{3}$$

$$\frac{1}{12} = 8\frac{1}{3}\%$$

$$\frac{7}{12} = 58\frac{1}{3}\%$$

$$\frac{11}{12} = 91\frac{2}{3}\%$$

$$\begin{array}{l} \textcircled{*} \frac{1}{6} = 16 \frac{2}{3} \% \quad \left| \quad \frac{1}{7} = 14 \frac{2}{7} \% \quad \right| \quad \frac{1}{8} = 12 \frac{1}{2} \% \quad 112 \\ \frac{5}{6} = 16 \frac{2}{3} \times 5 \quad \left| \quad \frac{4}{7} = 57 \frac{1}{7} \% \quad \right| \quad \frac{5}{8} = 62 \frac{1}{2} \% \\ = 83 \frac{1}{3} \% \quad \left| \quad \right| \quad \frac{3}{8} = 37 \frac{1}{2} \% \end{array}$$

$$\textcircled{*} \rightarrow \frac{11}{7} = 1 + \frac{4}{7} \Rightarrow 157 \frac{1}{7} \%$$

\downarrow \downarrow
 100% 57 $\frac{1}{7}$ %

$$\rightarrow \frac{31}{6} = 5 + \frac{1}{6} \Rightarrow 516 \frac{2}{3} \%$$

\downarrow \downarrow
 500% 16 $\frac{2}{3}$ %



$$\rightarrow \frac{37}{8} = 462 \frac{1}{2} \%$$

$(8 \times 4 \rightarrow 32 \rightarrow 400\% \quad (37-32=5 \rightarrow \frac{5}{8} \rightarrow 62 \frac{1}{2} \%))$

$$\rightarrow \frac{26}{3} = 886 \frac{2}{3} \%$$

$$\frac{21}{11} = 1 + \frac{10}{11} = 190 \frac{10}{11} \%$$

$$\rightarrow \frac{85}{16} = 531 \frac{1}{4} \%$$

New method for larger fractions.

$$\textcircled{\oplus} \quad 29 - 9 \frac{8}{39}$$

$$29 - 9 - \frac{8}{39}$$

$$20 - \frac{8}{39}$$

$$19 + 1 - \frac{8}{39}$$

$$19 \frac{31}{39}$$

$$\textcircled{\oplus} \quad \frac{23}{12}$$

$$200 - 8 \frac{1}{3} = 191 \frac{2}{3} \%$$

$$\textcircled{\oplus} \quad \frac{21}{11}$$

$$200 - 9 \frac{1}{11} = 190 \frac{10}{11} \%$$

$$\textcircled{24} - 1 \quad \frac{1}{2} = 0.5$$

$$200\% - 8 \frac{1}{3}$$

$$191 \frac{2}{3} \%$$

$$200 - 9 = 191$$

$$190 + 1 \frac{1}{11}$$

$$190 \frac{10}{11} \%$$



$$\textcircled{\#} \frac{44}{15} = 300 - 6\frac{2}{3} = 293\frac{1}{3} \%$$

$$\textcircled{*} \frac{39}{8} = 500 - 12\frac{1}{2} = 487\frac{1}{2} \%$$

$$300 - 7 = 293\frac{1}{3} \text{ Ans}$$

$$\frac{2}{3} \times 113 = 1 \text{ कमी}$$

so $\frac{1}{3}$

$$\textcircled{\#} 566\frac{2}{3} \% = 500 \% + 66\frac{2}{3} \% \Rightarrow 5 + \frac{2}{3} \Rightarrow 5\frac{2}{3} \Rightarrow \frac{17}{3}$$

$$\rightarrow 437\frac{1}{2} \% = 4 + \frac{3}{8} = \frac{35}{8}$$

$$\rightarrow 157\frac{1}{7} = 1 + \frac{4}{7} = \frac{11}{7}$$

$$\rightarrow 216\frac{2}{3} = 2 + \frac{1}{6} = \frac{13}{6}$$



$$\textcircled{\#} 25 \% = \frac{1}{4}$$

Result
original value/No.

$$4 \times 25 \% = 1$$

$$71\frac{3}{7} \% = \frac{5}{7}$$

$$7 \times 71\frac{3}{7} \% = 5$$

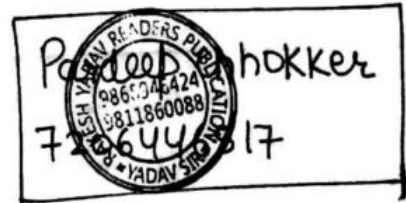

- ① if $16\frac{2}{3}\%$ of a no. is added with itself then result becomes 4956. find the original no.

$$16\frac{2}{3}\% = \frac{+1}{6}$$

original no.

$$6+1 = 7 \rightarrow 4956$$

$$1 \rightarrow 708$$

$$6 \rightarrow 708 \times 6 = 4248$$

original no. = 4248 Ans.

- ② if $6\frac{2}{3}\%$ of a no. is sub. from itself then result becomes 5670. find the original no.

$$6\frac{2}{3}\% = \frac{-1}{5}$$

O.N. $\times 405$

$$14 \rightarrow 5670$$

$$1 \rightarrow 405$$

6075 Ans

O.N.
- original no.

- ③ if $11\frac{1}{9}\%$ of a no. is added with itself then result becomes ~~4956~~⁹⁰⁰. Find the original no.

$$11\frac{1}{9}\% = \frac{+1}{9}$$

$\times 90$

$$10 \rightarrow 900$$

$$1 \rightarrow 90$$

810 Ans

- ④ if 64 is added in a no. then no. becomes $157\frac{1}{7}\%$ of itself. Find the number.

$$157\frac{1}{7}\% = \frac{11}{7}$$

$\times 16$

$$4 \rightarrow 64$$

$$1 \rightarrow 16$$

112 Ans

- ⑤ if 930 is added in a no. then no. becomes $444\frac{4}{9}\%$ of itself. find the original no.

$$444\frac{4}{9}\% = \frac{40}{9} \left. \begin{array}{l} 31 \longrightarrow 930 \\ 1 \longrightarrow 30 \\ \times 30 \\ \hline \end{array} \right\} \begin{array}{l} 444\frac{4}{9}\% \quad 115 \\ 400\% + 44\frac{4}{9}\% \\ 4 + \frac{4}{9} = \frac{40}{9} \end{array}$$

⑥ If 16 is added in a no. then result becomes $116\frac{2}{3}\%$ of itself. find the no.

$$116\frac{2}{3}\% \left(= \frac{7}{6} \right) + 1 \longrightarrow 16$$

$$\left[\times 16 \right] \longrightarrow 96 \text{ Ans}$$

⑦ if 21 is added in a no. then result becomes $137\frac{1}{2}\%$ of a no. find the no.

$$137\frac{1}{2}\% = \frac{11}{8} \left. \begin{array}{l} 3 \longrightarrow 21 \\ 1 \longrightarrow 7 \\ \times 7 \\ \hline \end{array} \right\} 56 \text{ Ans}$$

⑧ if the length of a rectangle is \uparrow by $37\frac{1}{2}\%$ and its breadth is \downarrow by 20%. Find the % change in its area.

	L	x	B	=	Area		$37\frac{1}{2}\% = +\frac{3}{8}$
ori. \rightarrow	8		5	=	40		
new \rightarrow	11		4	=	44		$20\% = \frac{1}{5}$

$$\% \text{ change in Area} = \frac{4}{40} \times 100 = 10\%$$

⑨ The price of sugar is \uparrow by $16\frac{2}{3}\%$ and the consumption of a family is \downarrow by 20%. find the % change in his expenditure.

	Price	x	cons.	=	Exp.		$16\frac{2}{3}\% = +\frac{1}{6}$
ori -	6		5	=	30		
New -	7		4	=	28		$20\% = \frac{1}{5}$

$$\frac{2}{30} \times 100 = 6\frac{2}{3}\%$$

- ⑩ The sale of a cinema ticket is \uparrow by $57\frac{1}{7}\%$ and price of ticket \uparrow by $16\frac{2}{3}\%$. Find the $\%$ change in his revenue.

	Sale	x	Price	=	Revenue	
ori \rightarrow	7		6	=	42) +35
New \rightarrow	11		7	=	77	

$$\frac{77-42}{42} \times 100$$

$$\frac{1}{6} = 16\frac{2}{3}\%$$

$$\frac{5}{6} \times 100 = 83\frac{1}{3}\%$$

$$\frac{5}{6} = 83\frac{1}{3}\%$$

- ⑪ if the sides of a square is \uparrow by 40% . Find the $\%$ change in its area.

	side	Area	
ori \rightarrow	5	25) +24
New \rightarrow	7	49	

$$\frac{24}{25} \times 100 = 96\%$$

- ⑫ The population of a town is 1,89,000. $\frac{4}{9}$ of them are males & rest females. 50% male are married. i) find the $\%$ of married population. ii) find the $\%$ of married female.

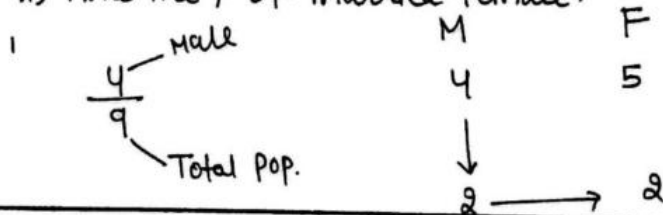

i) $\frac{4}{9} \times 100 = 44\frac{4}{9}\%$

ii) $\frac{2}{5} \times 100 = 40\%$

- ⑬ A labour works 60 Hr. per week and he earn Rs 2400 as wages. If his per hour wages \uparrow by 40% and duration of work reduced by $16\frac{2}{3}\%$. Find the $\%$ change in his income?

Rs/hr	x	hour	=	wages	
5 Rs/hr	x	6h	=	30) +5
7 Rs/hr	x	5h	=	35	

$$40\% = \frac{+2}{5}$$

$$16\frac{2}{3}\% = \frac{-1}{6}$$

$$\frac{5}{30} \times 100 = 16\frac{2}{3}\%$$

(14) A man multiply a no. by $\frac{7}{4}$ instead of $\frac{3}{5}$. find the % change in his revenue.

$$\begin{array}{l} \checkmark \frac{3}{5} \times 20 = 12 \\ \times \frac{7}{4} \times 20 = 35 \end{array} \left. \vphantom{\begin{array}{l} \checkmark \\ \times \end{array}} \right) 23 \quad \frac{23}{12} \times 100 \quad \left| \begin{array}{l} \text{let no.} \rightarrow 20 \\ \text{(LCM of 4,5)} \end{array} \right. \\ = 191\frac{2}{3}\%.$$

(15) A student multiplied a no. by $\frac{3}{5}$ instead of $\frac{5}{3}$. find the % error in the calculation.

$$\begin{array}{l} \checkmark \frac{5}{3} \times 15 = 25 \\ \times \frac{3}{5} \times 15 = 9 \end{array} \left. \vphantom{\begin{array}{l} \checkmark \\ \times \end{array}} \right) -16 \quad \frac{16}{25} \times 100 = 64\%.$$

(16) A student multiply a no. by $\frac{3}{4}$ instead of $\frac{4}{3}$. find % error in calculation.

$$\begin{array}{l} \checkmark \frac{4}{3} \times 12 = 16 \\ \times \frac{3}{4} \times 12 = 9 \end{array} \left. \vphantom{\begin{array}{l} \checkmark \\ \times \end{array}} \right) \quad \frac{7}{16} \times 100 = 43\frac{3}{4}\%.$$

(*) if the income tax in \uparrow by 19%. net income is \downarrow by 6%. find the rate of income tax.

Income Tax Net income

$$25 \quad 6 \quad 19$$

$$\frac{6}{25} \times 100 = 24\%$$

Tax $\frac{1}{\text{net income}}$

$$\frac{\text{Tax} \times 19}{100} = \text{NI} \times \frac{6}{100}$$

$$\frac{\text{Tax}}{\text{NI}} = \frac{6}{19} \quad \left| \begin{array}{l} \Rightarrow \text{Income} = \\ 6+19 = 25. \end{array} \right.$$

(#)

Income	Tax	Net income
100	20	80
100	25	75

-5

Tax में जो \uparrow होगा, उतना ही \downarrow NI में होगा & vice-versa

- 18) if the income tax is ↑ by 17% then net income is reduced by 3%. find the rate of income tax. 118

$\text{Tax} \times \frac{17}{100} = \text{NI} \times \frac{3}{100}$ $\frac{\text{Tax}}{\text{NI}} = \frac{3}{17}$	<table border="0" style="width: 100%; border-collapse: collapse;"> <tr> <td style="text-align: center;">Income</td> <td style="text-align: center;">Tax</td> <td style="text-align: center;">Net income</td> </tr> <tr> <td style="text-align: center;">20</td> <td style="text-align: center;">3</td> <td style="text-align: center;">17</td> </tr> <tr> <td colspan="3" style="text-align: center; padding-top: 10px;"> $\frac{3}{20} \times 100 = 15\%$ </td> </tr> </table>	Income	Tax	Net income	20	3	17	$\frac{3}{20} \times 100 = 15\%$		
Income	Tax	Net income								
20	3	17								
$\frac{3}{20} \times 100 = 15\%$										

19)

Seats (s) $\times 71\frac{3}{7}\% = 25$

$s \times \frac{5}{7} = 25 - 5$

$s = 35$

wagons = 35

Total sheets = 1225

$1225 \times \frac{80}{100} = 980.$

In a train there are as many wagons as there are no. of seats in each wagon. In one of the wagon carrying 25 persons is filled with $71\frac{3}{7}\%$ of its capacity. find the maximum no. of passengers that can be accommodated if it has min 20% seats always vacant.

- 20) A man can type 20 lines in 10 minutes but he leaves 8% margin on each line. In how much time he will type 23 pages with 40 lines on each page on w/c he leaves 25% more margin than before.

1 min → 2 lines

8% margin → 92% type

Efficiency (1min) ⇒ 2 × 92%

$\frac{5}{40 \times 23 \times 90\%} = 450 \text{ min.}$



$8 \times \frac{25}{100} = 2$

$8 + 2 = 10\%$ margin now

- 21) if x earns 25% more than y. what % less does y earn than x.

$\frac{x}{5} \rightarrow \frac{y}{4} \Rightarrow \frac{1}{5} \times 100 = 20\%$

- 22) if Kirshan salary is $16\frac{2}{3}\%$ less than Radha. By how much % does Radha's salary is more than Kirshan.

$\frac{K}{5} \rightarrow \frac{R}{6} \Rightarrow \frac{1}{5} \times 100 = 20\%$

$16\frac{2}{3} = \frac{1}{6}$

$$\begin{array}{r} 40\% \quad -50 \\ 50\% \quad +40 \\ \hline 90 \rightarrow 10\% \\ 1\% \rightarrow 9 \end{array}$$

$$\frac{50}{9} = 5 \frac{5}{9}\%$$

$$\begin{aligned} \text{pass}\% &= 40 + 5 \frac{5}{9} \\ &= 45 \frac{5}{9}\% \end{aligned}$$

28) When a student score 30% marks then he fails by 5 marks. But when he scores 40% marks he got 10 more marks than passing %. Find (i) Maximum marks (ii) Passing %.

$$\begin{array}{r} 30\% \quad -5 \\ 40\% \quad +10 \\ \hline 10\% \quad \quad 15 \\ 1\% \quad \quad 1.5 \end{array}$$

max. marks = 150

$$\begin{aligned} \text{Pass marks} &= 30 + 3 \frac{1}{3} \\ &= 33 \frac{1}{3}\% \end{aligned}$$

29) There are two types of animals in a room some are cats & some are dogs. Each cat takes 7 biscuits and each dog takes 9 biscuits. if 355 biscuits are eaten by 45 animals. find the no.

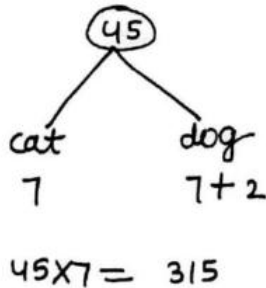

$$\begin{array}{r} 355 \\ -315 \\ \hline 40 \end{array}$$

$$\frac{40}{2} = 20 \text{ dogs}$$

Cats = 25

of cats & dogs. by allegation

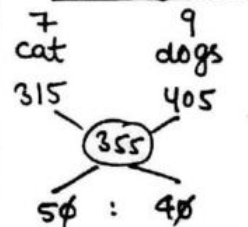

$$\begin{aligned} 9 &\rightarrow 45 \\ 1 &\rightarrow 5 \\ \text{Cats} &= 5 \times 5 = 25 \\ \text{dogs} &= 5 \times 4 = 20 \end{aligned}$$

30) In a zoo, there are rabbits and pigeons. if the heads are counted there are 280. if legs are counted there are 820. How many pigeons are there.

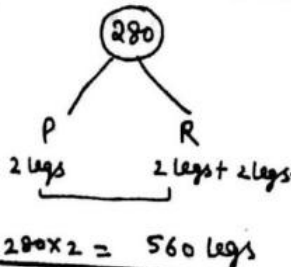

$$\begin{array}{r} 820 \\ -560 \\ \hline 260 \end{array}$$

Rabbits = 130

Pigeons = 150



31) The population of a town is 6000. If males are ↑ by 5%, and female are ↑ by 9%. then population will become 6500 after 1 year. Find the no. of males & females.

$$\frac{8}{100} \times 6000 = 300$$

$$\begin{array}{r} 500 \\ - 300 \\ \hline 200 \end{array}$$

$$F \times \frac{4}{100} = 200 \quad \left| \begin{array}{l} 1\% \rightarrow 50 \\ 100\% \rightarrow 5000 \end{array} \right.$$

$$F = 5000$$

$$M = 1000$$

32) The population of a village was 9600. if the males & females as \uparrow by 8% and 5% the population will become 10,272 after 1 year find the no. of males at present.

$$\frac{9600 \times 5}{100} = 480$$

$$\begin{array}{r} 672 \\ - 480 \\ \hline 192 \end{array}$$

$$3\% \rightarrow 192$$

$$1\% \rightarrow 64$$

$$\text{males} = 6400$$

$$\begin{array}{r} F = 9600 \\ - 6400 \\ \hline 3200 \end{array}$$



CLASS
15

33) A family consumes 25 kg rice and 9 kg wheat per month spends Rs 350. The price of rice is 20% of the price of wheat. if the price of wheat is \uparrow by 20% then find the % reduction in consumption of rice, if it has the same amount to spend. The price of rice is constant.

25 kg Rice	9 kg wheat	Rice	wheat
$1x$	$5x$	O.P \rightarrow 5 Rs/kg	25 Rs/kg
$25x$	$45x$	\downarrow constant	\downarrow 20% \uparrow
$25x + 45x = 350$		New P \rightarrow 5 Rs/kg	30 Rs/kg

$$x = 5$$

wheat = 25 Rs/kg
 Rice = 5 Rs/kg

$$\begin{array}{r} 350 \\ - 270 \\ \hline 80 \text{ Rs for consumption of rice} \end{array}$$

$$\frac{80}{5} = 16 \text{ kg}$$

Reduction in rice consumption =
 $25 - 16 = 9 \Rightarrow \frac{9}{25} \times 100 = 36\%$

- 34) In an election 2 candidates participated. 20% votes declared invalid and the winner gets 70% of the valid votes. and won by 9600 votes. find the no. of
 i) voting list ii) valid votes

122

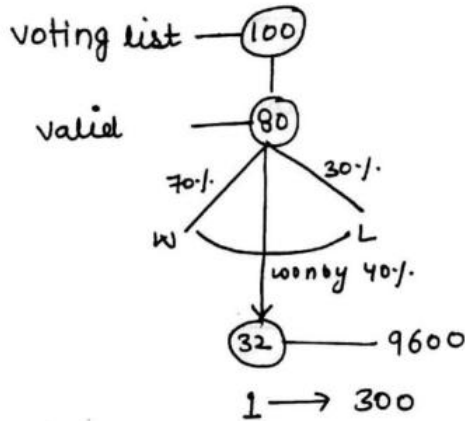

$$x \times \frac{4}{5} \times \frac{3}{5} = 9600$$

$$x = 30,000$$

x = voting list

$$20\% = \frac{1}{5} \text{ — invalid}$$

$$\text{valid} = \frac{4}{5}$$

$$\text{won by } 40\% = \frac{2}{5}$$

$$\frac{2}{5} \text{ of valid votes} = 9600$$

i) voting list = $100 \times 300 = 30000$

ii) valid votes = $80 \times 300 = 24000$

- 35) In an election two candidates participated. 20% votes did not vote. $12\frac{1}{2}\%$ votes declared invalid and winner get 60% of the valid vote and won by 5600 votes. find the no. of voter list.

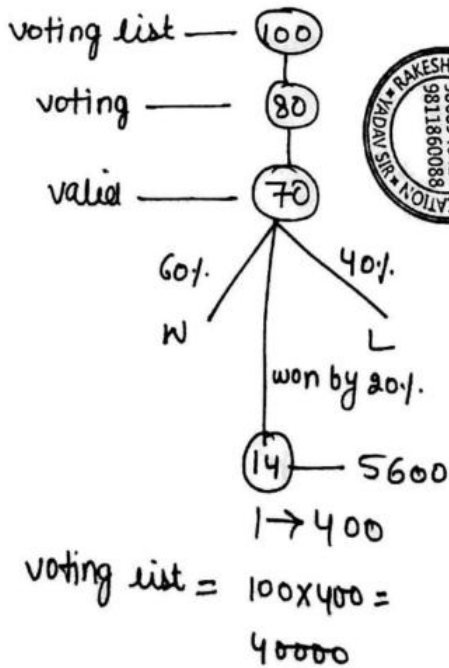

$$x \times \frac{4}{5} \times \frac{7}{8} \times \frac{1}{5} = 5600$$

$$x = 40,000$$

$$20\% = \frac{1}{5} \text{ — do not vote}$$

$$\text{voting} = \frac{4}{5}$$

$$12\frac{1}{2}\% = \frac{1}{8} \text{ — invalid}$$

$$\text{valid} = \frac{7}{8}$$

$$20\% = \frac{1}{5} \text{ (win margin)}$$

voting list = $100 \times 400 = 40000$

(36) In an election 10% voters did not vote and $11\frac{1}{2}\%$ votes declared invalid and the winner get 75% of the valid votes. if he win by 2000 votes then find the voting list.

123

$$x \times \frac{9}{10} \times \frac{8}{9} \times \frac{1}{2} = 2000$$

$$x = 5000$$

(37) In an election two candidates participated, 10% voters did not vote, out of which 10% votes declare invalid and the winner get 70% of the valid votes and win by 7290 votes. Then find the voting list.

voting list — (100)

voting — (90)

valid — (81)

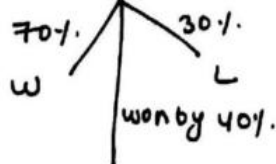

$$81 \times \frac{2}{5} \rightarrow 7290$$

$$1 \rightarrow \frac{7290 \times 5}{81 \times 2} = 225$$

$$\text{voting list} = 225 \times 100 = 22500$$

$$x \times \frac{9}{10} \times \frac{9}{10} \times \frac{2}{5} = 7290$$

$$x = \frac{7290 \times 10 \times 10 \times 5}{9 \times 9 \times 2}$$

$$x = 22500$$

(38) In an election two candidates participated. 20% voters did not cast their votes, out of w/c 600 votes declared invalid and the winner get 75% of valid votes and wins by 1500 votes. Find the no. of voting list.

$$\underbrace{\left(x \times \frac{4}{5} - 600\right)}_{\text{valid votes}} \times \frac{1}{2} = 1500$$

valid votes = $1500 \times 2 = 3000$

voting $\left(x \times \frac{4}{5}\right) = 3000 + 600 = 3600$

voting list $(x) = \frac{3600 \times 5}{4} = 4500$

OR

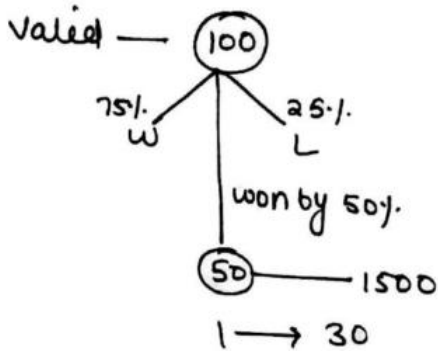

valid votes = $30 \times 100 = 3000$

voting = valid + invalid
 = $3000 + 600 = 3600$

$$\frac{4}{5} \begin{array}{l} \text{voting} \\ \text{total} \end{array}$$

4 → 3600
 1 → 900

Total votes = $900 \times 5 = 4500$

39) In an election two candidates participated, 10% voters did not vote, 2500 votes declared invalid and the winner gets 55% of the valid votes and wins by 2000 votes. Find the no. of voters in the voting list?

$$\left(x \times \frac{9}{10} - 2500\right) \times \frac{1}{10} = 2000$$

$$x = \frac{2500}{\frac{2500}{9} \times 10} = 25000$$

40) A salesman is allowed 12% commission on the total sales made by him and a bonus of 1% on the sales over 15000. If the total earning of the salesman is 7650 Rs, find the total sales.

Total sales = x

commission = $x \times \frac{12}{100}$

Bonus = $(x - 15000) \times \frac{1}{100}$

$\Rightarrow \frac{12x}{100} + (x - 15000) \times \frac{1}{100} = 7650$

$\Rightarrow \frac{12x}{100} + \frac{x}{100} - 150 = 7650$

$\frac{13x}{100} = 7800$

x = 60,000

Total sales = 60,000

15000	15000 +
↓	↓
12%	13%

125

अगर सारी sale पै 13% हो तो
salesman को (15000 पै 1%) का
extra benefit होगा।

$15000 \times \frac{1}{100} = 150$

Now his earning = 7650 + 150 = 7800

T.S का 13% = 7800

$T.S \times \frac{13}{100} = 7800$

T.S = 60,000

41) A salesman is allowed ~~12%~~ commission on the total sales made by him and a bonus of 1% on the sales over 20,000 if the total earning of the salesman is Rs 6800. find the total sale.

20,000	+
↓	↓
1%	10%

Now Total earning = 6800 + 200 = 7000

$T.S \times \frac{10}{100} = 7000$

T.S = 70,000

42) A salesman is allowed $5\frac{1}{2}\%$ commission on the total sales made by him and a bonus of $\frac{1}{2}\%$ on the sales over 10,000. if his total earning is Rs 1990, find the total sales.

$10,000 \times \frac{1}{200} = 50$

1990 + 50 = 2040

$T.S \times \frac{6}{100} = 2040$

T.S = 34000 Rs.

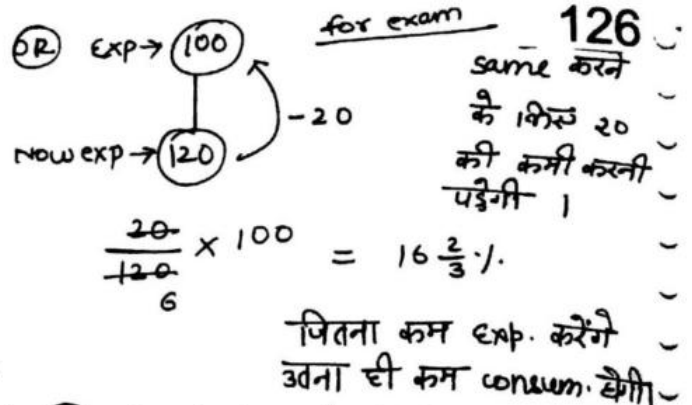
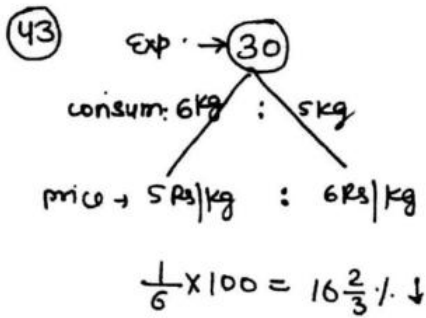

44 if the price of sugar is ↓ by 30%. Then by how much % the consumption ↑ so that the exp. remains same.

43 The price of sugar ↑ by 30%. By how much % the consumption is ↓ so that expenditure will not increase.

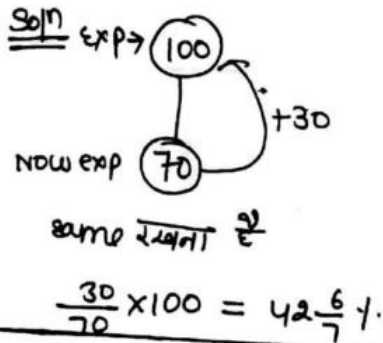

45 The price of sugar is ↓ by 30%. By how much % the consumption is ↑ so as the expenditure will ↓ by 10% only.

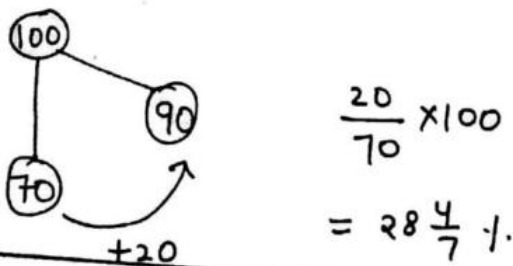

46 The price of sugar is ↑ by 20%. By how much kg of consumption is ↓ so as the expenditure will ↑ by 5% only when he originally consume 200 kg sugar.

$\frac{15}{120} \times 100 = 12\frac{1}{2}\%$

\Rightarrow

- 1 → dec. consumption
- 8 → original 127.
- 260
- 1 → 35

35 kg Ans.

47) The price of sugar is ↑ by 30% due to this a family use 40 kg less sugar so as expenditure will ↑ by 10% only. find original consumption.

$\frac{-20}{130}$

$\frac{-2}{13}$ — dec. cons.

- 2 — 40
- 1 — 20

original

x20

260 kg Ans.

48) The price of sugar is ↓ by 30% due to this a family purchase 32 kg more sugar so as the exp. will ↓ by 16% only. find the current consumption.

$= \frac{+1}{5}$ — 32

$\frac{32}{5}$ — o.c.

$\frac{32}{5} \times 32 = 160$

current cons =
 $32 + 160 = 192$

49) The price of sugar is ↑ by 20% due to this a family purchase 12 kg less sugar for Rs 300. find

i) original consumption iii) original price
 ii) current consumption iv) current price

OK

voting list — 100

voting — 90

valid — 90 (let)

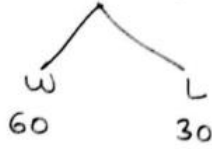

30 → 900 - 300 = 600

1 → 20

Not logical (समक अनु निकालने के लिए है) 129.

V.L — 100 × 20 = 2000

valid — 90 × 20 = 1800 - 300
= 1500

voting — 90 × 20 = 1800

52 In an election 2 candidate participate. 20% voters did not vote & 120 votes declare invalid. winner gets ~~200~~ more votes than his opponent winner wins by 200 votes and winner gets 41% of the voter list. find the voting list

Solⁿ

voting list — 100

voting — 80

valid — 80 (let)



2 → 200 - 120 = 80

1 → 40

V.L → 100 × 40 = 4000

voting → 80 × 40 = 3200

53 A company allowed 9% commission on the total sales to his salesmen. and a bonus of 1% on the sales over Rs 20,000. if the salesman deposited 63200 in the company after deducting his earning on the total sales. Find the total sales made by the salesman.

Total sales = x
 Commission = $x \times \frac{9}{100}$
 Bonus = $(x - 20,000) \times \frac{1}{100}$
 Earning = Comm. + Bonus
 $= \frac{9x}{100} + (x - 20,000) \times \frac{1}{100}$
 $= \frac{9x}{100} + \frac{x}{100} - 200$
 $= \frac{x}{10} - 200$
 T.S - Earning = 63,200
 $x - (\frac{x}{10} - 200) = 63,200$
 $\frac{9x}{10} = 63,000$
 $x = 70,000$ Ans.

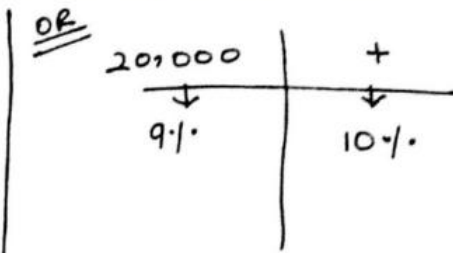

if company give 10% commission on all sale (company को 20000 पे 1% का less) होगा।
 $20,000 \times \frac{1}{100} = 200$
 company gets = 63200 - 200 = 63000
 $10\% = \frac{1}{10}$ — Earning
 — Total sale
 deposit = 10 - 1 = 9 → 63,000
 1 → 7000
 T.S = 10 × 7000 = 70,000 Ans.

(54) A company give 12% commission to his salesman on his total sales and above sales of 15000, 1% bonus. if the salesman deposited 52350 in the company after deducting his commission from total sales. find total sales.

$15,000 \times \frac{1}{100} = 150$
 $52,350 - 150 = 52,200$

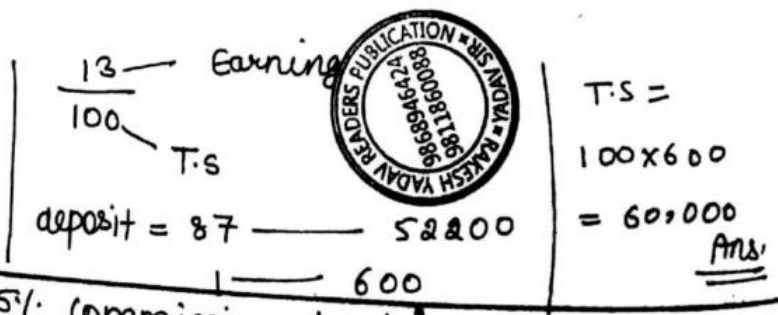

(55) A company give 5% commission to his salesman upto the sale of 10,000 and a ~~bonus~~ commission of 4% on the sales above 10,000. if the salesman deposited Rs 31,100 in the company after deducting his commission then find total sales.

$$10,000 \times \frac{1}{100} = 100$$

$$\text{Deposit} = 31100 + 100 = 31200$$

$$\frac{4}{100} = \frac{-1}{25}$$

$$\text{Deposit} = 24 - 1300 = 1300$$

$$T.S = 1300 \times 25 = 32500 \quad 131$$

56) A, B, C and D purchase a flat of 56 lakhs. The share of B+C+D is 460% of A, the share of A+C+D is 366 $\frac{2}{3}$ % of B and C's share is 40% of A+B+D. Find the share of D.

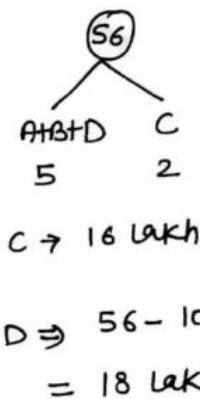
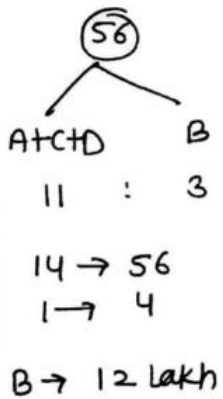
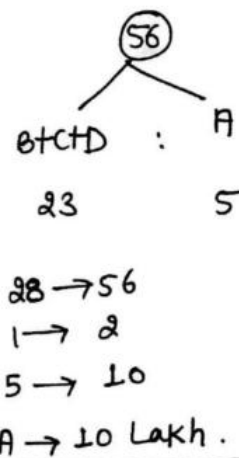

$$460\% = 4 + \frac{3}{5} = \frac{23}{5}$$



57) The price of sugar is ↓ by 20% due to this a family purchase 20 kg more sugar for Rs 400. find
i) original consumption iii) original price
ii) current consumption. iv) current price.

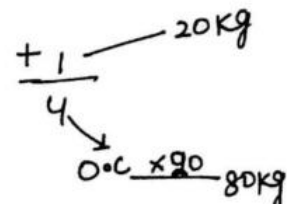
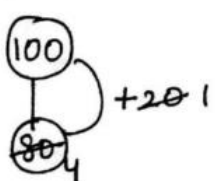

$$O.C = 80 \text{ kg}$$

$$O.P = \frac{400}{80} = 5 \text{ Rs/kg}$$

$$C.C = 100 \text{ kg}$$

$$C.P = \frac{400}{100} = 4 \text{ Rs/kg}$$

58) A reduction of Rs 2 per kg enables a man to purchase 4 kg more sugar for Rs 16. Find original price.

- A) 3 Rs/kg c) 5 Rs/kg
- B) 4 Rs/kg d) 6 Rs/kg

O. price = x Rs/kg

C. price = $(x-2)$ Rs/kg

$$\frac{16}{x-2} - \frac{16}{x} = 4$$

option से

Ans - B (4 Rs/kg)

59) A reduction of 50 paise/dozen in the price of eggs a person buy 1 dozen more eggs for Rs 66. find original price.

A) 5 Rs/kg C) 7 Rs/kg

O. price = x Rs/kg

B) 6 Rs/kg D) 8 Rs/kg

C. price = $x-50$

$$\frac{66}{x-0.5} - \frac{66}{x} = 1$$



6 Rs per dozen.

60) A man spends 60% of his income. If his income is ↑ by 15% and his expenditure is ↑ by 15%. find the % change in his saving.

Income	Exp.	Saving
500	300	200
+75	+45	+30
575	345	230

$$60\% = \frac{3}{5} \begin{matrix} \text{EXP.} \\ \text{I} \end{matrix}$$

$$\frac{30}{200} \times 100 = 15\% \uparrow$$

61) A man spends 75% of his income. if his income is ↑ by 20% & exp. is ↑ by 10%. Find the % change in the saving.

Income	Exp	Saving
400	300	100
+80	+30	+50

$$75\% = \frac{3}{4} \begin{matrix} \text{EXP} \\ \text{I} \end{matrix}$$

$$\frac{50}{100} \times 100 = 50\% \uparrow$$

Q) A man spends Rs 5700 out of his income of 8550. If his income and exp. is ↑ by 19% and 13%. find the % change in saving.

133

I	Exp	S
300	200	100
↓ +57	↓ +26	↓ +31
		131

$$\frac{8550}{3} : \frac{5700}{2}$$

$$\frac{31}{100} \times 100 = 31\% \uparrow \text{ Ans}$$

CLASS
17

Pardeep Chhoker
7206446517

Q63) The population of a town is ↑ by $16\frac{2}{3}\%$ in 1st year, ↓ by $37\frac{1}{2}\%$ in 2nd year, ↑ by $57\frac{1}{7}\%$ in 3rd year. Then find the present population if after 3 years the population will become 1,65,000.

(+)	(-)	(+)
$16\frac{2}{3}\%$	$37\frac{1}{2}\%$	$57\frac{1}{7}\%$
$+\frac{1}{6}$	$-\frac{3}{8}$	$+\frac{4}{7}$

$$x \times \frac{7}{6} \times \frac{5}{8} \times \frac{11}{7} = \frac{3000}{165000}$$

$$x = 1,44,000$$

6	7
8	5
7	11
48	55 → 165000
	1 → 3000

$$48 \rightarrow 48 \times 3000 = 144000$$



Q64) A man spends 5% of his total income in travelling and 20% of the rest spend in food and then he donate Rs 120 and he still left with 1400 Rs. find his income.

T	F
5%	20%
$-\frac{1}{20}$	$-\frac{1}{5}$

$$x \times \frac{19}{20} \times \frac{4}{5} - 120 = 1400$$

$$x \times \frac{19}{20} = \frac{80}{1520}$$

$$x = 2000 \text{ Rs}$$

OR	
20	19
5	4
100	76 → 1520
x 20	1720
2000 Rs	Ans

65) An electronic contractor has certain length of wire 134-
10% wire has stolen and 70% of the remaining was
sold out. Find the original length of wire if 810
mtr. wire is still left.

$$x \times \frac{9}{10} \times \frac{3}{10} = 810$$

$$x = 3000 \text{ mtr.}$$

66) In a library 20% of the books are in Hindi, 50% of
the remaining in English and 30% of the remaining
are in French and rest 6300 books are in regional
language. Then find the no. of books in library.

$$\begin{array}{ccc} H & E & F \\ 20\% & 50\% & 30\% \end{array}$$

$$\frac{1}{5} \quad \frac{1}{2} \quad \frac{3}{10}$$

$$x \times \frac{4}{5} \times \frac{1}{2} \times \frac{7}{10} = \frac{450}{900} \times 6300$$

$$x = 450 \times 2 \times 25$$

$$= 900 \times 25 = 22500$$

67) A manufacturer sold his goods to wholeseller at 25%
profit and the wholeseller sells it to retailer at 20%
profit and the retailer sold it to customer at 28% profit.
Then find the cost price of goods for manufacturer if the
customer purchase it at Rs 9600.

$$x \times \frac{5}{4} \times \frac{6}{5} \times \frac{32}{25} = \frac{50}{9600}$$

$$x = 5000$$

68) A spends 50% of his income on household items and of the
remaining 50% on transport, 25% on entertainment, 10% on
sports and remaining amount of 900 is saved. What is
Mr. A's monthly income.

$$x \times \frac{1}{2} \times \frac{15}{100} = 900$$

$$x = 12000 \text{ Ans}$$

T	E	SP
50	25	10

↓
85% of Remaining

saved = 15%

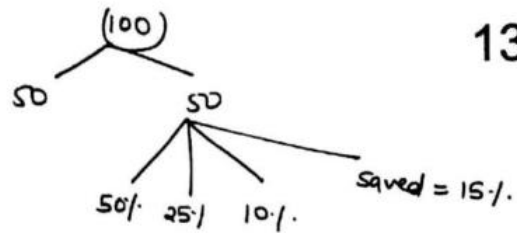

135

$$50 \times \frac{15}{100} = 900$$

$$1 \rightarrow 120$$

$$100 \rightarrow 12000$$

69) Mr. Max spent 20% of his income on food and 15% on childrens education, 40% of the remaining he spent on entertainment & transport together and 30% on medical. He is left with an amount of Rs 8775 after all these expenditures. What is Mr Max's monthly income.

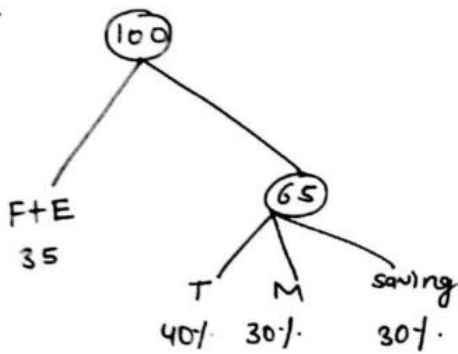

$$\frac{65}{100} \times \frac{30}{100} = 8775$$

$$1 \rightarrow \frac{8775 \times 2}{13 \times 3}$$

$$1 \rightarrow 450$$

$$100 \rightarrow 45000$$

OR

$$x \times \frac{65}{100} \times \frac{30}{100} = 8775$$

70) In a class of 60 children, 30% children can speak only English, 20% only Hindi and rest of the children can speak both the languages. How many children can speak Hindi?

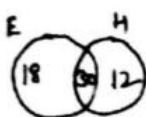

Hindi → 42

71) In an exam, 65% of the students passed in maths, 48% passed in physics and 30% passed in both. How much % of students failed in both the subjects. 136

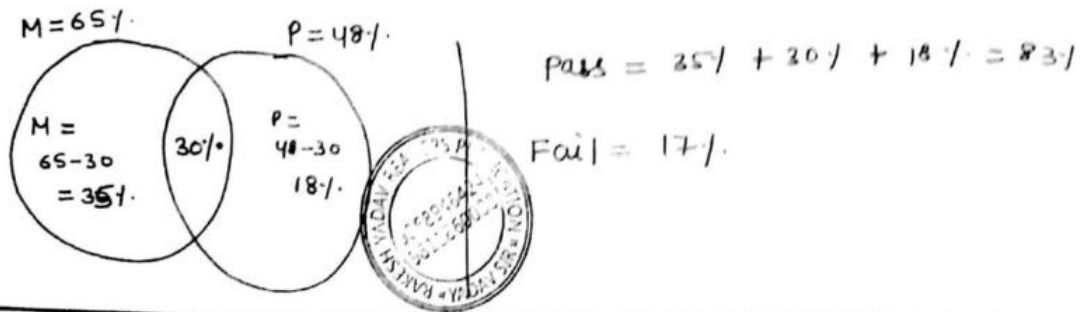

72) In an exam, 35% of the students failed in maths, and 25% in English. If 10% failed in both math & English then how much % passed in both the subjects.

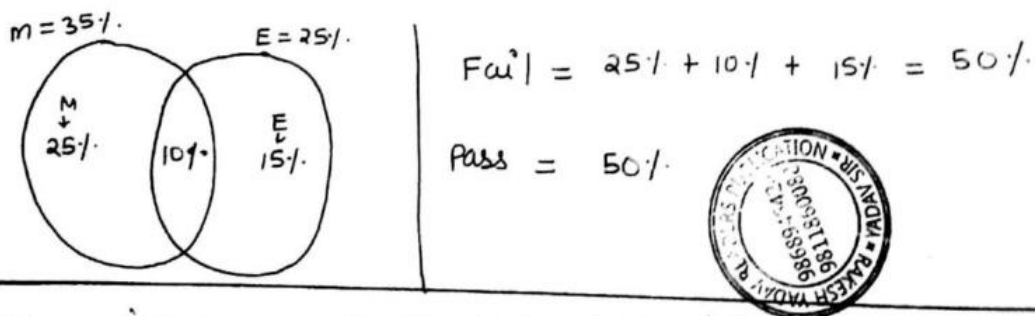

73) In a village each of the 60% of families has a cow, each of the 30% families has buffalo and each of the 15% of the families has both a cow and a buffalo. In all there are 96 families in the village. How many families do not have a cow or a buffalo.

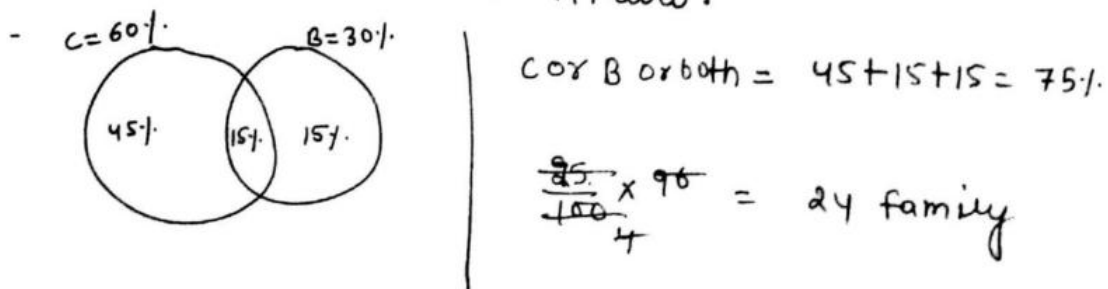

(74) if the numerator of a fraction is increased by 200% and the denominator is increased by 350%, the resultant fraction is $\frac{5}{12}$. What was the original fraction?

let the original fraction be $\frac{x}{y}$

ACQ:
$$\frac{x \times (100 + 200)\%}{y \times (100 + 350)\%} = \frac{5}{12}$$

$$\Rightarrow \frac{300x}{450y} = \frac{5}{12}$$

$$\Rightarrow \frac{x}{y} = \frac{5}{12} \times \frac{450}{300} \Rightarrow \frac{x}{y} = \frac{5}{8} \quad \underline{\text{Ans.}}$$



(75) A solution of salt and water contain 5% salt. If 20L of water is evaporated then salt becomes 15%. find the initial solution.

	<u>salt</u>	<u>water</u>	} salt is same throughout	<u>salt</u>	<u>water</u>
initial	1x3	19x3		1	19
new	3	17		15%	85%
				3	17

-40L → 20L
1 → 1/2

Initial solution = $60 \times \frac{1}{2} = 30L$ Ans

(76) 12 L of mix of acid & water contain 30% acid. How much litre of water should be withdrawn to make acid 40%.

	<u>Acid</u>	<u>water</u>	} (6+14) = 20L — 12L 1 — $\frac{12}{20} = \frac{3}{5}$ Ltr water withdrawn = $\frac{3}{5} \times 5 = 3L$
Initial	3x2 (6)	7x2 (14)	
new	2x3 (6)	3x3 (9)	

-5L

- 74) When income of a man is ↑ by 6000 Rs, tax rate reduced from 18% to 15%, while in both the situation 25% of the income is tax free. find his initial income, if he paid equal taxes in both cases.

$$x \times \frac{75}{100} \times \frac{18}{100} = (x+6000) \times \frac{75}{100} \times \frac{15}{100}$$

$$6x = 5x + 30000$$

$$x = 30,000$$

Tax rate 18% से 15% हुआ है तो 6000 बचे है

(CR)	x	x + 6000
	18%	15%

$$x \times \frac{3}{100} = 6000 \times \frac{5}{100}$$

$$x = 30,000$$

3% tax saving, 6000 पे 15% के equal है.

- 78) A man saves a certain part of his monthly income so that he can purchase a car in 16 months. Find the % ↑ in his saving so that he can purchase the same car in 14 months only.

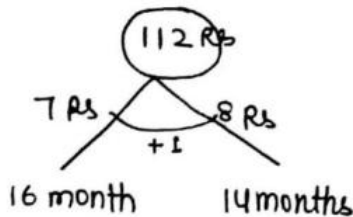

$$\Rightarrow \frac{1}{7} \times 100 \Rightarrow 14 \frac{1}{7} \% \uparrow$$

- 79) A watermelon contains 90% water. After some time it contains only 12% water, if now its weight is 50 kg calculate the original weight.

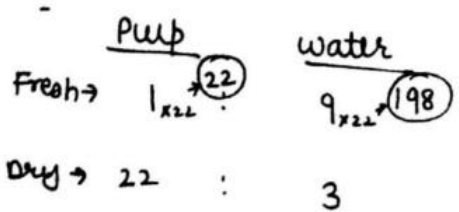

Pulp का wt. same रहता है
Fresh | Dry में

$$10 \times F = 88 \times 50$$

$$F_{resh} = 440 \text{ kg}$$

$$\text{Dry } (22+3) = 25 \rightarrow 50 \text{ kg}$$

$$1 \rightarrow 2 \text{ kg}$$

$$\text{wt. of fresh} = (22+198) \times 2 = 440 \text{ kg}$$

(80) 20 kg fresh watermelon contains 96% water, after some time water remains 95%. Find the present weight of watermelon.

139

$$\begin{array}{l} P \quad W \\ F \rightarrow 1 : 24 \end{array}$$

$$\rightarrow 4 : 96$$

$$1 : 24$$

$$D \rightarrow 1 : 19$$

$$\rightarrow 5 : 95$$

$$1 : 19$$

wt. of fresh melon $(1+24) = 25$ unit $\rightarrow 20$ kg

1 unit $\rightarrow \frac{4}{5}$ kg

$$\begin{array}{l} 20 \times 4 = 5 \times D \text{ melon} \\ D \text{ melon} = 16 \text{ kg} \end{array}$$

wt. of Dry melon $(1+19) = 20 \Rightarrow \frac{20 \times 4}{5} = 16$ kg Ans

(81) Fresh fruit contains 68% water and dry fruit contains 20% water. How many kg of dry fruits can be made from 75 kg of fresh fruits.

$$\begin{array}{l} 32 \times 75 = 80 \times Df \\ Df = 30 \text{ kg} \end{array}$$

$$\begin{array}{l} P \quad W \\ F \rightarrow 8 : 17 \end{array}$$

Fresh $(8+17) = 25$ unit $\rightarrow 75$ kg

1 $\rightarrow 3$ kg

$$D \rightarrow 4 \times 2 : 1 \times 2$$

Dry fruit $(8+2) \rightarrow 10 \rightarrow 10 \times 3 = 30$ kg Ans

(82) A company allow 7% commission on total sales to the salesman. But if the salesman is appointed on a fix salary of Rs 3000 + 4% commission on the sales more than Rs 10,000, then salesman receive Rs 800 more on the 2nd condition. find the total sales.

$$1^{st} \rightarrow x \times \frac{7}{100} = \frac{7x}{100}$$

$$2600 + \frac{4x}{100} = \frac{7x}{100} + 800$$

$$2^{nd} \rightarrow 3000 + (x-10000) \times \frac{4}{100}$$

$$x = 60,000$$

$$\rightarrow 3000 + \frac{4x}{100} - 400$$

$$\rightarrow 2600 + \frac{4x}{100}$$

83) In an election Kareena and Katrina participated 140. $\frac{2}{5}$ of the voters promised to vote for Kareena and rest promise to vote for Katrina. On the voting day 15% of the voters went back on their promise to vote for Kareena and 25% of the voters went back on their promise to vote for Katrina. Find the total no. of voters, if Kareena wins by 750 votes.

<u>Kareena</u>	:	<u>Katrina</u>
200	:	300
-30	:	-75
<hr/>	:	<hr/>
170	:	225
+75	:	+30
<hr/>	:	<hr/>
245	:	255
$\underbrace{\hspace{10em}}_{10}$		



$\frac{2}{5}$ → Kareena
 $\frac{3}{5}$ → Total
 2 : 3
 200 : 300

10 → 750
 1 → 75

Total votes = 500×75
 $= 37500$

84) Ram purchase 6 Black and x white balls. The price of black ball is $\frac{5}{2}$ of the price of the white ball. At the time of making the bill clerk made a mistake and interchange the no. of balls, due to this the bill amount increased by 45%. Find x.

<u>Black</u>		<u>white</u>
6	X	x
5 Rs		2 Rs
$30 + 2x$ (Right bill)		
$5x + 12$ (Wrong bill)		

$B = w \times \frac{5}{2}$
 $\frac{B}{w} = \frac{5}{2}$

$\frac{30+2x}{12+5x} = \frac{100}{145}$

$x = 15$

Profit = SP - CP

Loss = CP - SP

Profit % = $\frac{P}{CP} \times 100$

Loss % = $\frac{L}{CP} \times 100$

Discount = MP - SP

D% = $\frac{D}{MP} \times 100$

CP = $\frac{SP \times 100}{(100 + P)\%}$

CP = $\frac{SP \times 100}{(100 - L)\%}$

SP = $\frac{MP(100 - D)\%}{100}$

SP = $\frac{CP \times (100 + P)\%}{100}$



$$\frac{MP}{CP} = \frac{100\% + P\%}{100\% - D\%}$$

① Find the cost price of an article which is sold at Rs 630 at a profit of 12.5%.

12.5% = $\frac{1}{8}$ P
CP

SP = 9 — 630
1 — 70

CP = 8 × 70 = 560 Rs

② Find the CP of an article w/c is sold at Rs 1470 at a profit of 16 $\frac{2}{3}$ %.

16 $\frac{2}{3}$ % = $\frac{1}{6}$ P
CP

SP = 7 — 1470
1 — 210

CP = 6 = 6 × 210 = 1260 Rs

③ A shopkeeper sells his article at 16 $\frac{2}{3}$ % P on SP. Find his actual profit %.

16 $\frac{2}{3}$ % = $\frac{1}{6}$ P
SP

SP → 6
P → 1
CP → 5

Actual % P = $\frac{1}{5} \times 100$
= 20%

④ A shopkeeper sells his goods at 8 $\frac{1}{3}$ % P on SP. Find actual P%.

8 $\frac{1}{3}$ % = $\frac{1}{12}$ P
SP

SP = 12
P = 1
CP = 11

P% = $\frac{1}{11} \times 100$
= 9 $\frac{1}{11}$ %

⑤ A man sells his goods at 25% loss on SP. find his loss %.

$$25\% = \frac{1}{4} \text{ loss} \quad CP = 5 \quad \text{loss \%} = \frac{1}{5} \times 100 = 20\%$$

⑥ cost price of 16 articles is equal to SP of 14 articles. Find profit or loss %.

$$16 \times CP = 14 \times SP \quad \frac{CP}{SP} = \frac{7}{8} \Rightarrow P = 1 \quad | \quad P\% = \frac{1}{7} \times 100 = 14\frac{2}{7}\%$$

⑦ A man finds that CP of 2750 articles is equal to SP of 2500 articles. find P or L %.

$$\frac{CP}{SP} = \frac{2500}{2750} = \frac{10}{11} \Rightarrow P = 1 \quad | \quad P\% = \frac{1}{10} \times 100 = 10\%$$

⑧ cost price of 12 articles is equal to SP of 9 articles. while the discount on 10 article is equal to the profit earn on 5 articles. find the difference b/w P% & D%.

$12 \times CP = 9 \times SP$ $\frac{CP}{SP} = \frac{3}{4}$ $P\% = \frac{1}{3} \times 100 = 33.33\%$	$10 \times D = 5 \times P$ $\frac{D}{P} = \frac{1}{2}$	<table border="0"> <tr> <td>CP</td> <td>SP</td> <td>MP</td> </tr> <tr> <td>3</td> <td>4</td> <td>4.5</td> </tr> <tr> <td colspan="2">1</td> <td>0.5</td> </tr> </table>	CP	SP	MP	3	4	4.5	1		0.5
CP	SP	MP									
3	4	4.5									
1		0.5									

$P\% - D\% = 33.33\% - 11.11\% = 22.22\% \text{ Ans}$



$D\% = \frac{0.5}{4.5} \times 100 = 11.11\%$

⑨ CP of 12 articles is equal to SP of 9 articles while the D on 8 articles is equal to P on 6 articles. Find the diff b/w P% & D%.

$\frac{CP}{SP} = \frac{9}{12} = \frac{3}{4}$ $P\% = \frac{1}{3} \times 100 = 33.33\%$	$8 \times D = 6 \times P$ $\frac{D}{P} = \frac{3}{4}$	<table border="0"> <tr> <td>CP</td> <td>SP</td> <td>MP</td> </tr> <tr> <td>3x4</td> <td>4x4</td> <td>19</td> </tr> <tr> <td colspan="2">1x4</td> <td>3</td> </tr> </table>	CP	SP	MP	3x4	4x4	19	1x4		3
CP	SP	MP									
3x4	4x4	19									
1x4		3									

$P\% - D\% = 33.33\% - 15.79\% = 17.54\% \text{ A}$

$D\% = \frac{3}{19} \times 100 = 15.79\%$

10) After selling 72 articles a man loses SP of 9 articles. find L%.

143

SP of 1 Article = 1 Rs

loss = 9 Rs

SP = 72 Rs

CP = 72 + 9 = 81 Rs

loss % = $\frac{9}{81} \times 100$

= $11\frac{1}{9}$ %

By:
Pardeep Chhokker
7206446517

11) After selling 72 Articles a man earns a profit of SP of 9 articles. find profit %.

SP of 1 Article = 1 Rs

profit = 9 Rs

SP = 72 Rs

CP = 72 - 9 = 63

P% = $\frac{9}{63} \times 100$

= $14\frac{2}{7}$ %

12) After selling 72 Articles a man earns a profit of CP of 9 article. find profit %.

CP of 1 Article = 1 Rs

P = 9 Rs

CP of 72 Articles = 72 Rs

P% = $\frac{9}{72} \times 100$

= $12\frac{1}{2}$ %



13) After selling 10 candles a man earn a profit of the SP of 3 pens. While selling 10 pens a man losses SP of 4 candles.

The numerical value of P% and L% is equal and the CP of candle is half of the CP of the pen. find the ratio of SP of candle to pen.

	candle	pen
CP →	x	2x
SP →	a	b

CP → 10x

P → 3b

P% → $\frac{3b}{10x} \times 100$

CP → 20x

loss → 4a

L% → $\frac{4a}{20x} \times 100$

⇒ P% = L%

$\frac{3b}{10x} \times 100 = \frac{4a}{20x} \times 100$

3b = 2a

$\frac{a}{b} = \frac{3}{2}$ Ans

- (14) The profit earned when article is ~~set~~ sold for ¹⁴⁴Rs 800 is 20 times the loss incurred when it is sold for Rs 275. find at what price he sold his goods if he wants to earn 20% P.

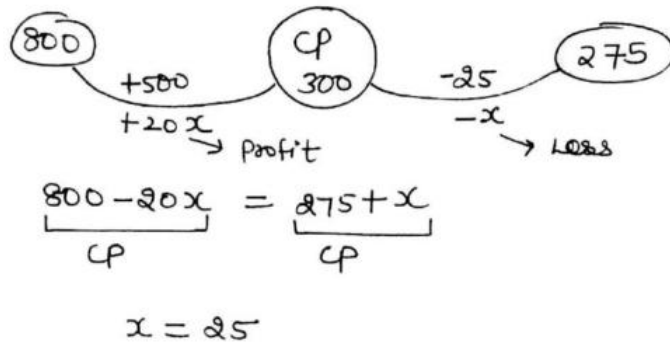

$$CP = 300$$

$$P = \frac{300 \times 20}{100} = 60$$

$$SP = 300 + 60 = 360$$

(OR)

$$800 - 275 = 525$$

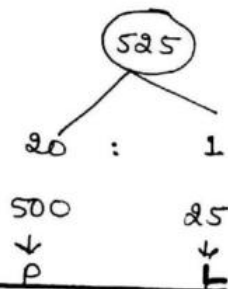

- (15) Profit after selling an article for Rs 717 is $11\frac{1}{9}\%$ ^{more than} of the loss incurred when it is sold at Rs 527. What would be the selling price if he wants to earn a profit of 10%.

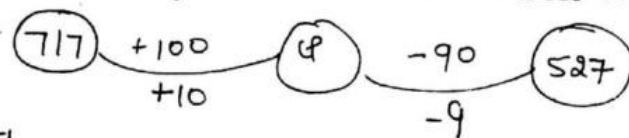

$$11\frac{1}{9}\% = \frac{10}{9}$$

$$717 - 527 = 190$$

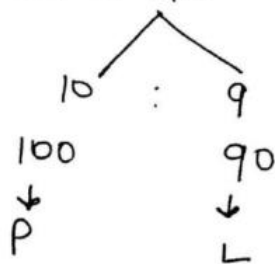

$$CP = 617$$

$$P = 61.7$$

$$SP = 617 + 61.7 = 678.7 \text{ Rs.}$$

(6) A shopkeeper sells at 9% less. Had he sold it Rs 750 more than he would gain 7%. find initial cost price.

145

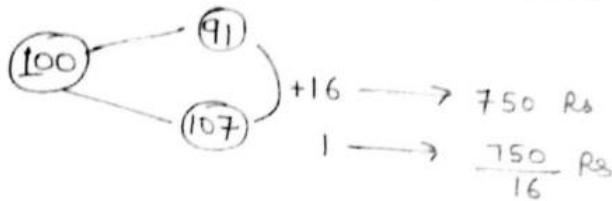

$$\text{initial cp} = 100 \times \frac{750}{16} = 4687.50 \text{ P.}$$

(17) A shopkeeper sells his goods at 7% P. Had he sold it Rs 4248 more than he would gain 13% P. find initial CP.

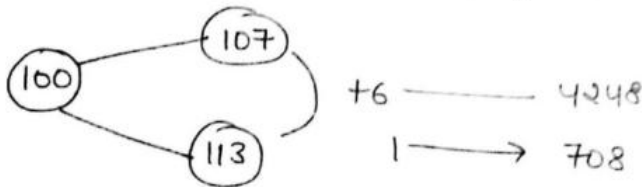

$$\text{CP} = 100 \times 708 = 70800$$

(18) A shopkeeper sells his goods at 30% P. Had he purchase it for 10% less and sold it Rs 18 less than he would gain 30% find initial CP.

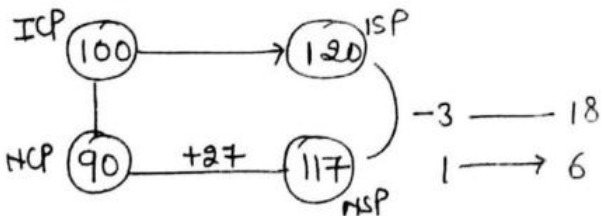

$$90 \times \frac{30}{100} = 27$$

$$\text{Initial cp} = 100 \times 6 = 600 \text{ Rs.}$$

(19) A man sell his goods at 10% P. Had he purchase it for 20% less and sold it for Rs 20 more than he would gain 40%. find initial CP.

$$80 \times \frac{40}{100} = 32$$

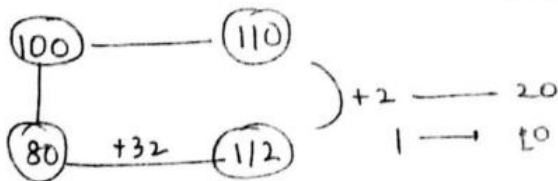

$$\text{initial cp} = 100 \times 10 = 1000 \text{ Rs.}$$

CLASS

19

20) A man sells his goods at 25% profit. Had he purchase it for 900 less and sold it for 900 less then he would gain 5% more profit. find the initial cost price.

$$P = 25\% = \frac{1}{4} \quad \begin{array}{cc} \text{ICP} & \text{ISP} \\ 4x & 5x \end{array}$$

$$\begin{array}{l} \text{NCP} \\ \text{NSP} \end{array} \quad \frac{4x - 900}{5x - 900} = \frac{10}{13}$$

$$52x - 11700 = 50x - 9000$$

$$2x = 2700$$

$$x = 1350$$

$$\text{ICP} = 4 \times 1350 = 5400 \text{ Rs.}$$

OR

4×3	5×3	
2 (diff same # तर # तर multiply)		$\Rightarrow 2 \rightarrow 900$
$\frac{10}{900}$	$\frac{13}{900}$	$1 \rightarrow 450$
		$12 \rightarrow 12 \times 450$
		$= 5400 \text{ Rs.}$

$$30\% = \frac{3}{10}$$

OR

$$\frac{30}{5} \times 900 = 5400 \text{ Rs.}$$

21) A man sells his goods at 20% profit. Had he purchase it for Rs 600 less and sold it for Rs 400 less then he would gain 10% more profit. find the initial cost price.

$$20\% = \frac{1}{5}$$

$$\begin{array}{cc} \text{ICP} & \text{ISP} \\ 5x & 6x \end{array}$$

$$\frac{5x - 600}{6x - 400} = \frac{10}{13}$$

$$5x = 3800$$

$$\text{ICP} = 3800 \text{ Rs.}$$



22) A man purchase some article (a) 11 article for Rs 10 and sells all the articles (a) 10 article for Rs 11. find P% or L%.

Article	Price	
11 x 10	10 x 10	(100)
10 x 11	11 x 11	(121)

) +21

$$\frac{21}{100} \times 100 = 21\% \text{ P}$$

(23) A man purchase some pencils @ 6 pencils for Rs 5 with he sells all the articles @ 5 article for Rs 6. Find overall profit or loss %.

Article	price	
6x5	5x5	(25)
5x6	6x6	(36)

+11 $\frac{11}{25} \times 100 = 44\% P$

(24) A man purchase some orange @ 1 orange for Rs 2 and same no. of oranges @ 2 orange for Rs 1 and he sells all of them @ 4 oranges for Rs 3. Find profit or loss %.

	Article	price	price/article	
CP	1	2 Rs	$\frac{2}{1} \times 4 = 8$	
CP	2	1 Rs	$\frac{1}{2} \times 4 = 2$	
SP	4	3 Rs	$\frac{3}{4} \times 8 = 6$	$\frac{4}{10} \times 100 = 40\% L$

OR

	Article	price	
CP	1x2	2 Rs x 2	
CP	2	1 Rs	
CP	4	5 Rs) -2
SP	4	3 Rs	

$\frac{2}{5} \times 100 = 40\% L$



(25) A man buys some oranges at the rate of 5 for Rs 1 and same no. of oranges @ 4 for Rs 1. He sold all of them @ 9 for Rs 2. During the whole transaction he incurs a loss of 30 Rs. Find the no. of articles that he purchase.

	Article	Price	
CP	5	$\frac{1}{5} \times 180$) -2 → 30
CP	4	$\frac{1}{4} \times 180$	
SP	9	$\frac{2}{9} \times 360 = 80 Rs$	

360 Articles CP → 80 Rs

$360 \times 30 = 10,800$ Any

(5, 4, 9) HCF LCM → 180

- (26) A dishonest shopkeeper promise to sell his goods at its cp but he uses 30% less weight. Find the profit %.

148

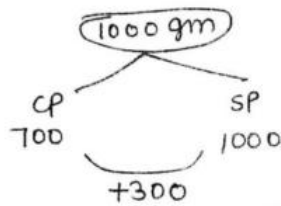

$$\frac{300}{700} \times 100 = 42\frac{6}{7} \%$$

- (27) A dishonest shopkeeper promise to sell his goods at its cp. but he uses 960 gm wt. instead of 1kg. Find P%.

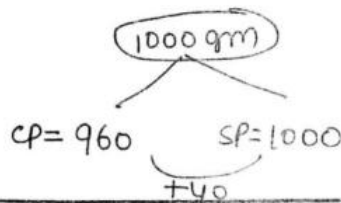

$$\frac{40}{960} \times 100 = 4\frac{1}{6} \% P$$

- (28) A shopkeeper promise to sell his goods at 44% loss but he uses 30% less weight. Find actual loss %.

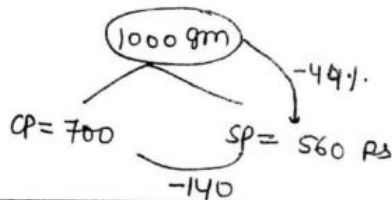

$$\frac{140}{700} \times 100 = 20\% L$$

- (29) A shopkeeper promise to sell his goods at 10% profit but he uses 20% less weight. Find the profit %.

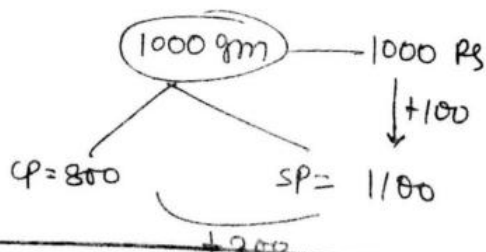

$$\frac{300}{800} \times 100 = 37\frac{1}{2} \% P$$

- (30) A shopkeeper promise to sell his goods at x% ~~loss~~ profit but he uses 20% less weight thus gain 37½%. Find x.

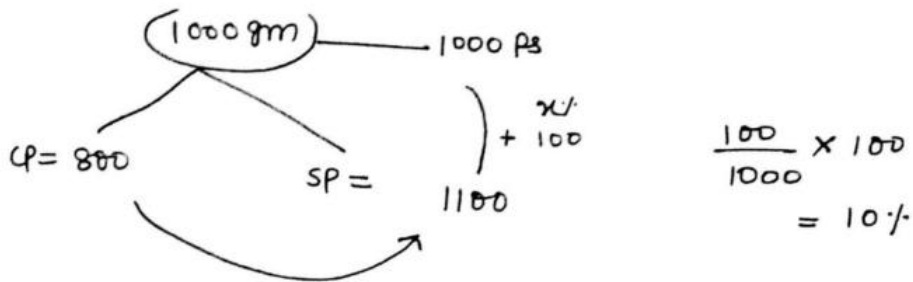

$37\frac{1}{2}\% = \frac{3-P}{8} \times CP$
 $SP = 11$
 $CP 8 \text{ --- } SP 11$
 $CP 800 \text{ --- } SP 1100$

31) A shopkeeper promise to sell his goods at $x\%$ loss but he uses 20% less weight thus gain 20% . find x .

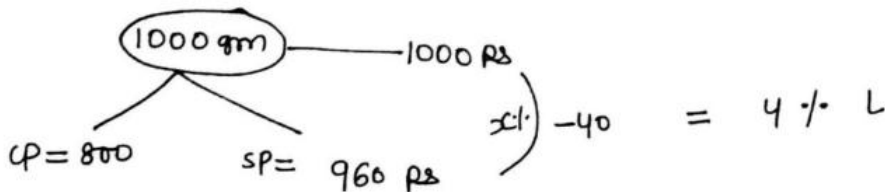

$20\% = \frac{1-P}{5} \times CP$
 $CP 5 \text{ --- } SP 6$
 $\left. \begin{array}{l} \\ \end{array} \right\} \begin{array}{l} \times 160 \\ \times 160 \end{array}$
 $800 \quad \quad \quad 960$

32) A shopkeeper promise to sell his goods at $x\%$ loss but he uses 25% less weight thus gain 20% . Find x .

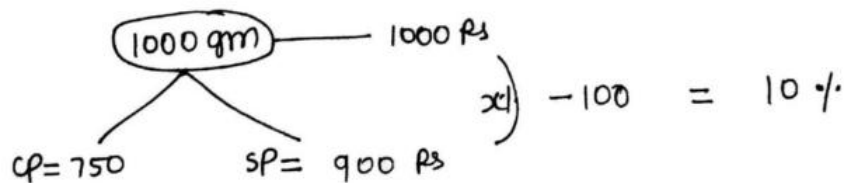

$20\% = \frac{1-P}{5} \times CP$
 $SP = 6$
 $\left. \begin{array}{l} 5 \text{ --- } 750 \\ 1 \text{ --- } 150 \end{array} \right\}$
 $6 \text{ --- } 900$

33) A dishonest shopkeeper makes a cheating of 20% at the time of buying the goods and 40% cheating at the time of selling the goods. He promise to sell his goods at 10% loss. find the profit %.

1000 gm — CP = 1000 Rs

1200 gm — CP = 1000 Rs

2 x 600 gm — SP = 900 Rs (10% L)

1200 gm — SP = 1800 Rs

$$P\% = \frac{800}{1000} \times 100 = 80\%$$

(34) A shopkeeper marks his goods 40% above the CP and gives 25% discount to customer. At the time of selling the goods he uses 800 gm weight instead of 1kg. Find his profit %.

4 x 1000 gm — CP = 1000 Rs x 4 = 4000
 5 x 800 gm — SP = 1050 Rs x 5 = 5250 } 1250

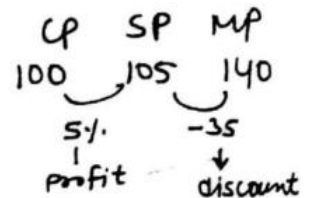

$$\frac{1250}{4000} \times 100 = 31.25\%$$

$$140 \times \frac{25}{100} = 35$$

(35) A shopkeeper marks his goods 20% above the CP and gives 10% discount to the customer. At the time of selling the goods he uses 900 gm weight instead of 1kg and at the time of buying he uses 1100 gm instead of 1 kg. Find his profit %.

1000 gm — CP = 1000 Rs
 x 9 1100 gm — CP = 1000 Rs x 9 = 9000
 x 11 900 gm — SP = 1080 Rs x 11 = 11880 } +2880

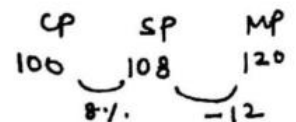

$$\frac{2880}{9000} \times 100 = 32\% P$$

(36) A dishonest shopkeeper makes a cheating of 10% at the time of buying the goods & 10% cheating at the time of selling the goods. Find the profit %.

100 gm — cp = 100 Rs

9 x 110 gm — cp = 100 Rs x 9 = 900

11 x 90 gm — sp = 100 Rs x 11 = 1100

151

$\frac{200}{900} \times 100 = 22 \frac{2}{9} \%$

SSC इसका Ans 21% मानता है

$\frac{10 + 10 + \frac{10 \times 10}{100}}{100} = 21\%$

37) A man purchase some no. of oranges at the rate of 11 oranges for Rs 1. How many for a Rs did he sell to gain 10%.

price	100	:	110
	10	:	11
quantity	11	:	10
	↓		↓
	11 orange		10 orange

Article → 11 orange : 10 orange
Price → 10 Rs/orange : 11 Rs/orange

38) A man purchases some no. of oranges @ 25 oranges for Rs 2. How many for a Rs did he sell to gain 25%.

Price	100	:	125
	4	:	5
quantity	5	:	4
	x5		x5
	25 orange		20 orange

अगर sale | purchase की amount same करनी है तो जैसा इस type में है price का जो ratio होगा उसके opposite quantity का ratio होगा
20 orange Ans

39) By selling 32 oranges for a Rs a man loss 40%. How many for a rupee did he sell to earn 20%.

Price	60	:	120
	1	:	2
Quan.	2	:	1
	x16		x16
	32 orange		16 orange Ans

Pardeep Chokker
7206446517

40) By selling 12 oranges for a Rs a man ~~loss~~ 20%. How many for a Rs did he sell to earn 20% 152

Price	80	:	120	
	2	:	3	
Quantity	3	:	2	
	x4		x4	
	12 oranges		8 oranges	<u>Ans</u>

41) By selling 45 oranges for Rs 40 a man loss 20%. How many did he sell for Rs 24 to earn 20%.

Price	80	:	120
	2	:	3
Q.	3	:	2
	x15		x15
	45		30

40 Rs — SP = 30 oranges

1 Rs — SP = $\frac{30}{40}$

24 Rs → $\frac{30}{40} \times 24 = 18$ oranges.

CLASS
20



42) Bhuvnesh makes 750 articles at a cost of 60 paise/article. He fixed the selling price such that if only 600 articles are sold, he would have made profit of 40% on the outlay. However, 120 articles got spoilt and he was able to sell 630 articles at this price. Find his actual profit % as the percentage of total outlay assuming that the unsold articles are useless.

CP = $750 \times \frac{60}{100} = 450$ Rs

SP = $450 \times \frac{140}{100} = 630$



600 Articles — SP = 630 Rs

1 Article — SP = $\frac{630}{600} = \frac{21}{20}$ Rs

SP of 630 articles = $\frac{21}{20} \times 630 = 661.5$ Rs

P = 661.5 - 450 = 211.5 Rs

P% = $\frac{211.5}{450} \times 100 = 47\%$

OR

CP = 100 Rs

600 A — SP = 140

1A — SP = $\frac{140}{600} = \frac{7}{30}$

630 Article — SP = $\frac{7}{30} \times 630 = 147$

Profit % = 47%

→ अगर amount of profit पूछा होता तो ये नहीं apply कर सकते। P% पूछा है तो real data की need नहीं है। comparison करना है कोई भी value उठा लो

(43) A man purchase some no. of articles at Rs 5400 and he sells $\frac{2}{3}$ rd of them at 5% profit. At what profit % did he sell the remaining to gain 13% overall.

2 x 5% = 10%

1 x 29% = 29%

3 x 13% = 39%

29% Ans.



(44) A man purchase some no. of articles at Rs 189000 and he sells $\frac{3}{8}$ of them at 12% profit. At ^{what} % did he sell the remaining to gain 4% overall.

$$\begin{array}{r} 3 \times 12\% = +36\% \\ 5 \times \frac{4}{5}\% = -4\% \\ \hline 8 \times 4\% = +32\% \end{array}$$

45) A manufacturer estimates that on inspection 12% of the articles he produces will be rejected. He accepts an order to supply 22,000 articles at Rs 7.50 each. He estimates the profit on his outlay including the manufacturing of rejected article to be 20%. find cost of manufacturing each article.

$$SP = 22000 \times \frac{88}{100} \times 7.50$$

$$20\% = \frac{1}{5} \begin{array}{l} \text{--- P} \\ \text{--- CP} \end{array} \quad SP = 6$$

$$6 \text{ unit} \rightarrow 22000 \times \frac{88}{100} \times 7.50$$

$$\text{CP} \rightarrow \begin{array}{l} 22000 \\ \text{Articles} \end{array} \quad 5 \rightarrow \frac{22000 \times 88 \times 7.50 \times 5}{6 \times 100}$$

$$CP (\text{per Article}) = \frac{22000 \times 88 \times 7.50 \times 5}{6 \times 100 \times 22000} = 5.50 \text{ Rs.}$$

DISCOUNT

Buy 5 get 4 free

$$\begin{array}{l} MP \text{ of } 1 \text{ Article} = 10 \text{ Rs} \\ MP \text{ of } 9 = 90 \text{ Rs} \\ SP \text{ of } 5 = 50 \text{ Rs} \end{array} \quad \left. \begin{array}{l} \\ \\ \end{array} \right\} -40$$

$$\begin{aligned} D\% &= \frac{40}{90} \times 100 \\ &= 44\frac{4}{9}\% \end{aligned}$$

Buy 3 get 3 free

$$\begin{array}{l} MP \text{ of } 6 = 60 \text{ Rs} \\ SP \text{ of } 3 = 30 \text{ Rs} \end{array} \quad \left. \begin{array}{l} \\ \end{array} \right\} 30$$

$$\begin{aligned} D\% &= \frac{30}{60} \times 100 \\ &= 50\% \text{ discount} \end{aligned}$$



⊕ Buy 5 get 4 free + 20% more discount

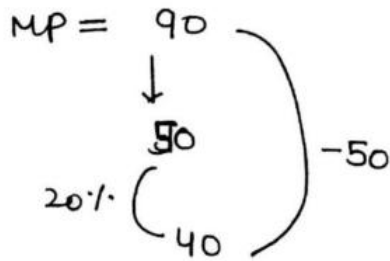

$$D\% = \frac{50}{90} \times 100 = 55\frac{5}{9}\% \text{ discount}$$

⊕ Buy 4 get 5 free + 50% more discount

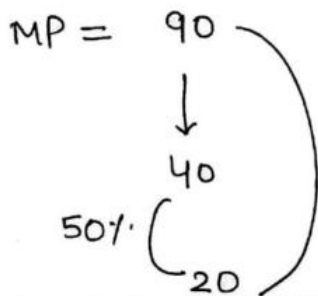

70 $\frac{70}{90} \times 100 = 77\frac{7}{9}\% \text{ discount}$

46) A shopkeeper allow 25% discount on mark price and earn 30% profit. If he gets Rs 90 as profit. find the amount of the discount.

CP	SP	MP
	3x13	4x13
$\frac{10 \times 3}{30}$	$\frac{13 \times 3}{39}$	52
P = 9	D = 13	
x10	x10	
90	130 Rs	<u>Ans</u>

25% = $\frac{1}{4}$ (D, MP)
 SP = 3

30% = $\frac{3}{10}$ (P, CP)
 SP = 13

47) By how much % a shopkeeper mark his goods above its CP so as by giving 20% discount he may gain 10%.

<p>CP SP MP</p> <p> 4x11 : 5x11</p> <p>$\frac{10 \times 4}{40} : \frac{11 \times 4}{44} = \frac{55}{55}$</p> <p style="text-align: center;">+15</p> <p>$\frac{15}{40} \times 100 = 37\frac{1}{2}\%$</p>	<p>OR</p> <p>(100% - D%) (100% + P%) 156</p> <p>CP MP</p> <p>80 110</p> <p style="text-align: center;">+30</p> <p>$\frac{30}{80} \times 100 = 37\frac{1}{2}\%$</p>
--	--

(48) By how much % a shopkeeper mark his goods above its CP so as by giving 10% discount he may gain 30%.

<p>CP MP</p> <p>96 136</p> <p style="text-align: center;">4</p> <p>$\frac{4}{9} \times 100 = 44\frac{4}{9}\%$</p>
--

(49) A shopkeeper mark his goods at such a price that after allowing a discount of 12.5% on the mark price he can earn a profit of 20% of the article cost him Rs 1400 then find its mark price.

<p>CP MP</p> <p>$1 - \frac{1}{8}$ $1 + \frac{1}{5}$</p> <p>$\frac{7}{8} : \frac{6}{5}$</p> <p>35 : 48</p>
--



35 → 1400
 1 → 40 Rs
 48 → 40 × 48 = 1920 Rs

(50) A shopkeeper gives 25% discount to his customer but he sells only smuggled goods and as a bribe he pays 10% on the cost price. Find what should be the MP if he desires to make a profit of 9 1/11% and the cost price of article is 2500 Rs.

Pardeep Chhokker 157
7206446517

CP		MP
$1 - \frac{1}{4}$:	$1 + \frac{1}{11}$
$\frac{3}{4}$:	$\frac{12}{11}$
11	:	16
$\downarrow \times 250$		$\downarrow \times 250$
2750		4000

$$2500 \times \frac{10}{100} = 250$$

$$2500 + 250 = 2750 \text{ Rs.}$$

51) By selling an article for Rs 1170 a man allow 10% discount and earn 30% profit. if the article is sold at 0% discount what should be the profit %.

CP	MP
90	130

If sold at 0% discount then it is sold at MP means

$$SP = 130$$

$$P\% = \frac{40}{130} \times 100 = 44 \frac{4}{9} \%$$

52) By selling an article for 15600 Rs a man allow 8% discount and 19.6% profit. if the article is sold at 0% discount what should be the profit %.

CP	MP
92	119.6
276	119.6 SP

$$\frac{27.6}{92} \times 100 = 30\%$$

53) By selling an article for Rs 1170 a man allow 10% discount and earn 30% profit. if the article is sold at 5% discount what should be the profit %.

CP	MP
90	130
+335	-6.5 Rs (-5%)
	123.5 SP

$$\frac{33.50}{90} \times 100 = 37 \frac{2}{9} \%$$

54) A shopkeeper give 3 articles free on purchase of 158 articles. He also allow ~~allow~~ a discount of 20% & still earn 25% profit. find the ratio of cost price and mark price.

Buy 5 get 3 free + 20% D.

$$MP = 80$$

$$\downarrow$$

$$50$$

$$\downarrow 20\%$$

$$SP = 40$$

$$25\% = \frac{1}{4} P$$

$$SP = 5$$

$$5 \rightarrow 40$$

$$1 \rightarrow 8$$

$$CP = 4 \times 8$$

$$= 32 \text{ Rs}$$

$$CP : MP$$

$$32 : 80$$

$$2 : 5 \quad \underline{\underline{\text{Ans}}}$$

OR

CP

$$\frac{80}{8}$$

$$10$$

$$2$$

MP

$$\frac{125}{5}$$

$$25$$

$$5$$

:

:



55) A shopkeeper give 1 article free on the purchase of every 15 article, he also allow a discount of 4% to customer and still earn 35% profit. find the ratio of CP & MP.

CP

$$96$$

$$\frac{96}{16}$$

$$6$$

$$2$$

MP

$$135$$

$$\frac{135}{15}$$

$$9$$

$$3$$

:

:

:

(56) A shopkeeper give 4 articles free on the purchase of every 12 articles he also allow a discount of 20% to customer and still earn 20% profit. find the ratio of CP to MP of the article.

159

CP	MP
80	120
$\frac{80}{16}$	$\frac{120}{12}$
5	10
1	2

(57) Rakesh Yadav Readers publication published 3500 books for 3,50,000 Rs at CP, he give 500 books free to some book shops, he also allowed a discount of 25% on the mark price and give 1 book free for every purchase of 29 books. find the amount of profit or loss if the mark price of each book is 160 Rs.

$$CP = 3,50,000$$

$$SP = 2900 \times 120 = 3,48,000$$

$$\text{loss} = 2000$$

29 Books — 1 free

if 30 books sold, money will come only of 29 books

3000 books then money will be of 2900 books.

$$160 \times \frac{25}{100} = 40$$

$$160 - 40 = 120 \text{ Rs.}$$

(58) A rickshaw dealer buys 30 rickshaws for Rs 4725. of these 8 are four seaters and the rest are two seaters. At what price must he sell the four seaters so that if he sells the two seaters at $\frac{3}{4}$ th of this price, he makes a profit of 40% on his outlay.

Four seater Two seater

FB →	8	22
SP	4x	3x
	32x	66x

40% = $\frac{2-P}{5} \times CP$

CP - 5 → 4725
1 → 945

SP → 7 → 945 × 7 = 6615

32x + 66x = 6615

98x = 6615

x = 67 approx

4x = 67 × 4 = 268 ⇒ 270 Rs

CLASS
21

Equation

30% Book + 40% Pen = Profit

40% Book + 30% Pen = Profit + 800

-10% B + 10% P = -800

$\frac{10}{100} (B - P) = -800$

B - P = 8000

~~800 × 10~~
~~100~~

$\frac{800}{10} \times 100 = 8000$

59) A man sold a book at 9% Profit and a pen at 13% P. If he sold the book at 13% Profit and the pen at 9% Profit, he gain Rs 80 more. find the cost price of book and pen. if he ~~sell~~ purchase both at Rs 20,000.

9% B + 13% P = [P]

13% B + 9% P = [P] + 80 Rs

B - P = $\frac{80}{4} \times 100 = 2000$

B + P = 20,000

B - P = 2,000

B = 11,000

P = 9000

60) A man purchase a book and a pen for Rs 25000. He sell the book at 13% P and pen at 17% Profit. if he sold the book at 17% profit and pen at 13% profit he earns Rs 80 more. find their individual cost price.

161

$$B + P = 25,000$$

$$B - P = 2000$$

$$\frac{80}{4} \times 100 = 2000$$

$$B = 13,500$$

$$P = 11,500$$

61) A shopkeeper bought two cycles in Rs 1600. if he sold 1st cycle at 10% profit and 2nd at 20% profit, he earns a certain profit. if he sold 1st at 20% P & 2nd at 10% P, he get Rs 5 more. The prices of both the cycles is ?

$$T_1 + T_2 = 1600$$

$$\frac{5}{100} \times 100 = 50$$

$$T_1 - T_2 = 50$$

$$T_1 = 825$$

$$T_2 = 775$$

62) The total cost of 8 books and 5 pens is 92. then find the cost of 3 books and 2 pens if the cost of 5 books & 8 pens is 77.

$$8B + 5P = 92$$

$$5B + 8P = 77$$

$$\text{Add} \rightarrow 13B + 13P = 169$$

$$B + P = 13$$

$$B - P = 5$$

$$B = 9$$

$$P = 4$$

subtract

$$3B - 3P = 15$$

$$B - P = 5$$

$$3B + 2P$$

$$27 + 8$$

$$= 35 \text{ Rs.}$$

63 Rakesh yadav has 2 bats and 1 ball. The cost of ball is 96. If he sells the ball along the value of the 1st bat, the amount received will be twice the value of the 2nd bat. But if he sells the ball with the 2nd bat, the amount received will be less than the value of the 1st bat by Rs 306. What is the value of the 1st bat?

$$\begin{array}{l}
 A \quad B \quad \text{ball} = 96 \\
 A + 96 = 2B \quad | \quad B + 96 = A - 306 \\
 A = 996 - 96 \quad | \quad B = 2B - 96 - 306 - 96 \\
 \boxed{A = 900} \quad | \quad \boxed{B = 498}
 \end{array}$$



64 Rakesh yadav sells a pen at 5% loss and a book at 15% P, he gets Rs 7 as profit. If he sells the pen at 5% profit & the book at 10% profit, he gets Rs 6 more. The prices of book & pen are?

$$\begin{array}{l}
 -5\%P + 15\%B = 7 \quad \text{(i)} \\
 5\%P + 10\%B = 13 \quad \text{(ii)} \\
 \frac{25}{100} B = 20 \\
 \boxed{B = 80}
 \end{array}$$

$$\begin{array}{l}
 \text{put value of B in (i)} \\
 -5\%P + \frac{3}{100} \times 80 = 7 \\
 -5\%P = 7 - 12 = -5 \\
 \frac{5}{100} P = 5 \\
 \boxed{P = 100}
 \end{array}$$

65 A man sells a table at 12% loss and a book on 19% profit, & earns a profit of 160 Rs but if he sell the table 12% profit & book at 16% loss then he bears a loss of 40 Rs. find the price of the book.

$$\begin{array}{l}
 -12\%T + 19\%B = 160 \\
 12\%T - 16\%B = -40 \\
 \hline
 3\%B = 120 \\
 \frac{3}{100} B = \frac{120}{100} \\
 \boxed{B = 4000}
 \end{array}$$

Ans

$$\begin{array}{l}
 \text{put in eq (ii)} \\
 \frac{12}{100} T - \frac{16}{100} \times 4000 = -40 \\
 \frac{12}{100} T = -40 + 640 = \frac{600}{100} \\
 \boxed{T = 5000Rs}
 \end{array}$$

T = 5000Rs

66) A man sells a table at 15% profit and a chair at 12% loss & earns 540 Rs as profit. If he sell the table at 12% loss & chair at 15% profit then he bears no profit no loss. find the price of table & chair. 163

$$-12\% \cdot T + 15\% \cdot C = 0$$

$$\frac{15}{100} C = \frac{12}{100} T$$

$$\frac{C}{T} = \frac{4}{5}$$

T	C
500	400
75	- 48
27 unit — 540	

$$\begin{aligned} \text{Table} &= 500 \times 20 \\ &= 10000 \\ \text{Chair} &= 400 \times 20 \\ &= 8000 \end{aligned}$$

67) A man sells a book and a table at 13% & 19% profit respectively & earns 1060 Rs as profit. But if he sells the book at $16\frac{2}{3}\%$ P and Table at $11\frac{1}{9}\%$ less then bears no profit no loss. find their CP?

$$\frac{1}{6} B = \frac{1}{9} T$$

$$\frac{B}{T} = \frac{2}{3}$$

BOOK	Table
200	300
26	+ 27
53 — 1060	
1 —> 20	

$$\begin{aligned} \text{BOOK} &= 20 \times 200 = 4000 \\ \text{Table} &= 6000 \end{aligned}$$



68) A man sell two articles first at 15% loss & 2nd at 19% profit. if during the whole transaction he bears a loss of 90 Rs if he sell both article at same price then find the cost price of 2nd article.

	I	II
CP	20x7	100
P/L	-3x7	+19
SP	17x7	119

$$\begin{aligned} \text{loss} &= 2 \longrightarrow 90 \\ &1 \longrightarrow 45 \end{aligned}$$

$$\text{CP of 2nd article} = 45 \times 100 = 4500 \text{ Rs.}$$

69) A man sell two articles first on 20% loss and 2nd on 60% profit. Find their selling price if the diff b/w the CP is 3200 Rs if the selling price of both the articles is same.

	I	II	
CP	5x2	5	$CP_1 - CP_2 = 5 \rightarrow 3200$
PL	-1x2	+3	$1 \rightarrow 640$
SP	4x2	8	$SP = 640 \times 8 = 5120 \text{ Rs.}$



70) A man sell 3 article at same price. 1st on 20% profit, and on 10% loss, 3rd on 25% loss. During the whole transaction he bears a loss of Rs 120. find the selling price of each article?

	I	II	III	
CP	5x3	10x2	4x6	$loss = +3 - 2 - 6 = 5$
PL	+1x3	-1x2	-1x6	$5 \rightarrow 120$
SP	6x3	9x2	3x6	$1 \rightarrow 24$
				$SP = 18 \times 24 = 432 \text{ Rs.}$



71) A man sells two articles for Rs 1710. He sells 1st at 10% loss & 2nd at 25% profit. find the amount of overall profit/loss if the cost price of 1st article is equal to the selling price of 2nd article.

	I	II	
CP	10	4x2	$SP = 9 + 10 = 19 \rightarrow 1710$
PL	-1	+1x2	$1 \rightarrow 90$
SP	9	5x2	$PL = -1 + 2 = +1 \rightarrow 90 \text{ Rs Profit}$

72) The selling price of A & B are Rs 1800 each. A calculate his P% on SP while B on CP. find the diff b/w their CP if both claims 20% profit.

	A	B
CP	4x6	5x5
PL	+1x6	+1x5
SP	5x6	6x5

36 → 180¢
 1 unit → 60
 Diff. (CP_{AB}) = 25 - 24 = 1 unit
 = 60 Rs.

73) A and B purchase an article on same price. Later on C purchase both article from A and B at Rs 240 each from A & B. But the profit % of A was P% while profit % of B was Q%. Since B calculate his profit on SP. if C sells one of the article to D at P% profit what is the cost price for D if $Q = 41\frac{2}{3}\%$ P?

	A	B
CP	x	x
SP	240	240

$x \times \frac{P}{100} = 240 \times \frac{Q}{100}$
 $x \times P = 240 \times \frac{5}{12} Q$
 $x = 100$ Rs.
 $Q = \frac{5}{12} P$
 $\frac{Q}{P} = \frac{5}{12}$

(A)
 CP = 100
 SP = 240
 P% = $\frac{140}{100} \times 100$
 P% = 140%

(C) — CP = 240
 SP = $\frac{140}{100} \times 240 = 336$
 336 + 240 = 576 Rs.



Cost price for D = 576 Rs.

74) A company allow 15% discount to his customers and still earn 19% profit. If the production cost of the product is ↑ by 12%. therefore company issued a new list price w/c is 10% higher than the previous list price and company still allow 15% discount to his customers. find the new profit % of the company.

$$\frac{CP}{MP} = \frac{85}{119} = \frac{5}{7}$$

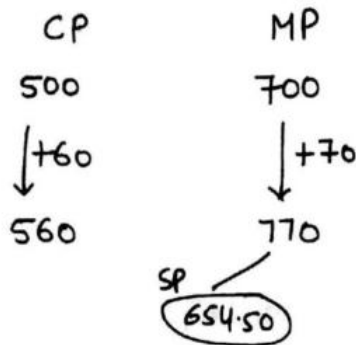

$$770 \times \frac{15}{100} = 115.50$$

$$\%P = \frac{94.50}{560} \times 100$$

$$= 16 \frac{7}{8} \%$$



75) A man purchase a home and a shop. He sold the shop at 10% P and home at 10% Less. and selling price of both the articles is same (1,00,000 Rs each) find the amount of loss.

	I	II
CP	10×9	10×11
P/L	$+1 \times 9$	-1×11
SP	11×9	9×11

$$CP = 90 + 110 = 200$$

$$L = 2$$

$$\frac{2}{200} \times 100 = 1\% \text{ Loss.}$$

$$\% = \frac{-1}{100} \times 100$$

SP = 99

$$SP = 99 \text{ ————— } 2 \text{ lakh}$$

$$1 \text{ ————— } \frac{2}{99} \text{ lakh.}$$

76) A dealer sold 2 TV set for Rs 2400 each. and earn 20% profit on 1st article and 20% loss on 2nd article. find his total profit or loss.

4% loss

$$\frac{1}{25} \times 100 = 4\% \text{ loss}$$

SP = 24	—————	4800
1	—————	200

loss = 200 Rs.

if selling price of two articles is same & one is sold at x% profit & other is sold at x% loss. Then overall

$$\text{Loss\%} = \frac{-x^2}{100}$$

Q.2) A shopkeeper bought some books at discount of 20% on list price. If he want to mark them at such a price given that after giving a discount of 20% he still makes a profit of 25%. find the % of the list price he should mark on his goods above its CP. 167

CP = 80

$$P = 25\% = \frac{1}{4} P$$

$$4 \rightarrow CP$$

$$4 \rightarrow 80$$

$$1 \rightarrow 20$$

SP = 5

SP = 20 x 5 = 100

↳ But this value is obtained after giving 20% discount.

$$D = 20\% = \frac{1}{5} MP$$

$$5 \rightarrow MP$$

$$SP = 4 \rightarrow 100$$

$$1 \rightarrow 25$$

MP → 5 ⇒ 25 x 5 = 125

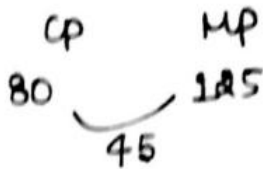

$$\frac{45}{80} \times 100 = \frac{225}{4} = 56\frac{1}{4}\%$$

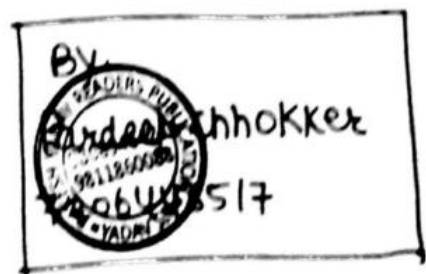
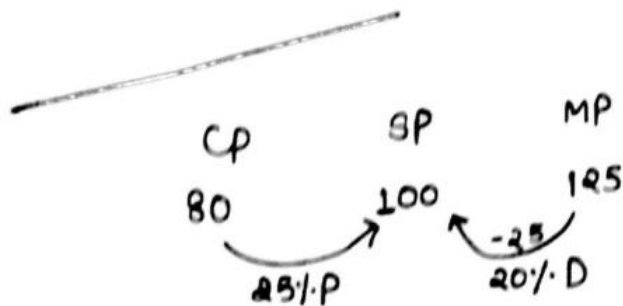

CLASS 22

MIXTURE & ALLEGIATION

169

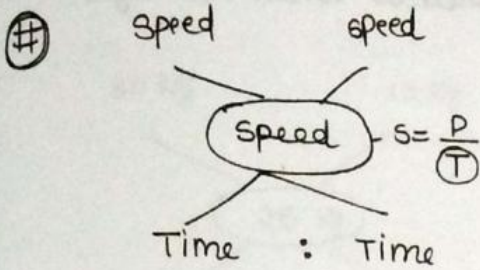

Mean वाली चीज जिसके Respect में निकाली जाती है, ratio उसी का आता है।

$S = \frac{P}{T}$, speed को time के Respect में निकालते हैं। So. Time का ratio आयेगा।

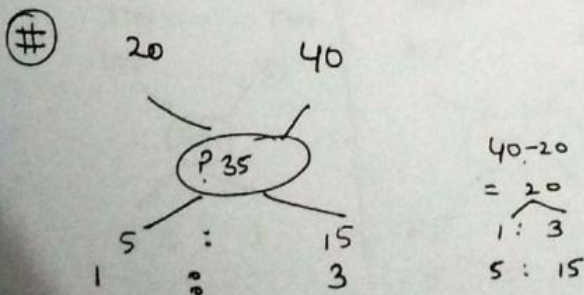
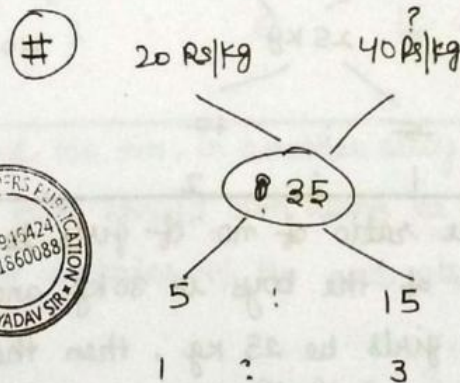
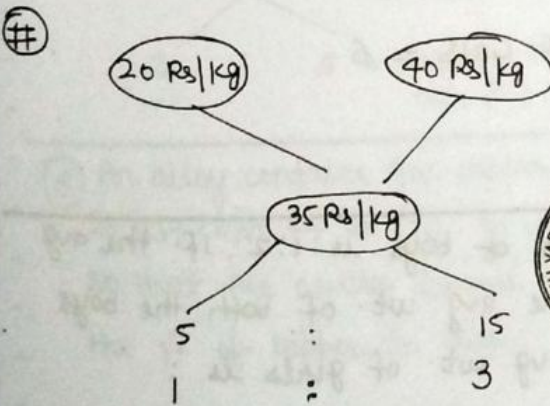
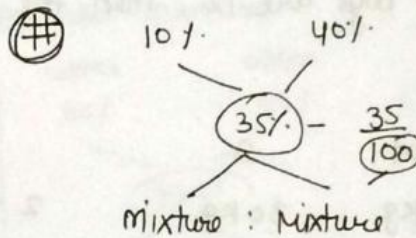
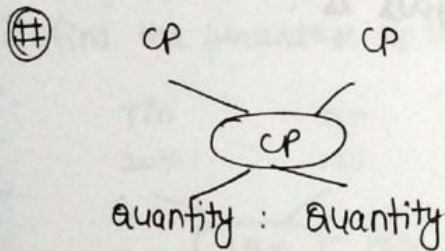
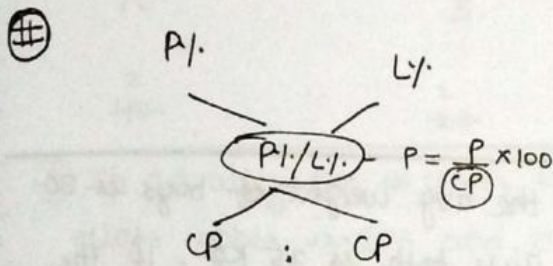

- ① If the avg. weight of a class is 15 kg and the avg weight of another class is 30 kg. then find the ratio of the students of the first class to another class students when the avg. weight of both the classes is 25 kg.

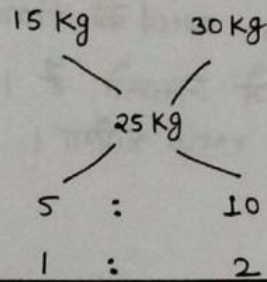

- ② The avg. weight of girls is 15 and the avg weight of boys is 30 and the avg weight of boys and girls both is 25 kg. If the no. of boys are 12, then the no. of girls is :

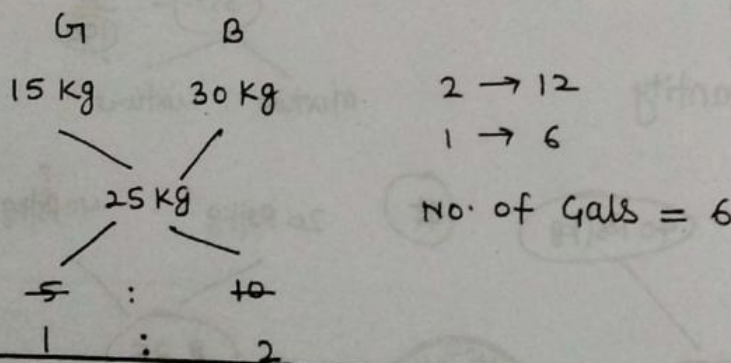

- ③ The ratio of no. of girls to no. of boys is 1:2. if the avg wt. of the boys is 30 kg and the avg wt. of both the boys and girls be 25 kg, then the avg wt. of girls is :

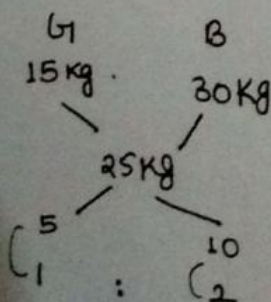

4) The avg weight of a class of 40 students is 30 kg and the avg. weight of a class of 20 students is 15 kg. find the avg weight of both the classes combined. 171

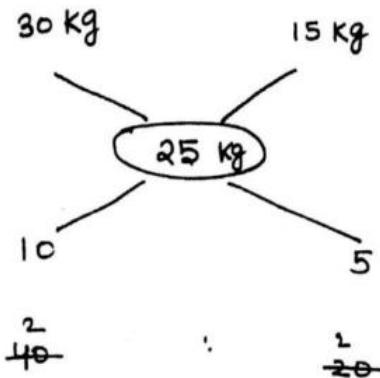

$$30 - 15 = 15$$

$$\begin{array}{c} 15 \\ \swarrow \quad \searrow \\ 2 : 1 \\ 10 \quad 5 \end{array}$$

5) In an alloy 80% is copper and the remaining tin. In another alloy, copper is 85% and tin is 12%. In what ratio should the two alloys be mixed so that the new mixture must have 15% tin. Also find the percentage of copper in the new mixture.

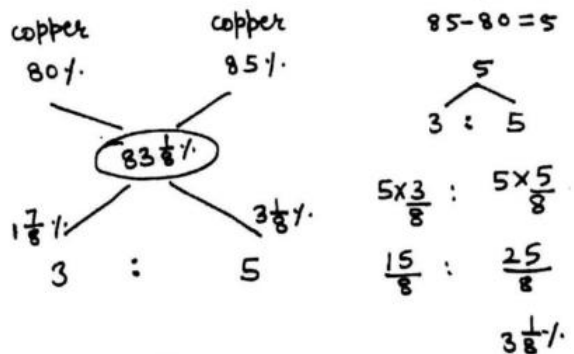
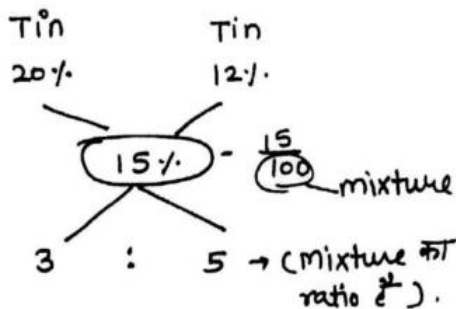

6) An alloy contains 90% copper and 10% tin, in another alloy copper is 93% and 4% is tin. In what ratio should both alloys be mixed so that the newly formed alloy contains 9% tin and also find the % of copper in this:

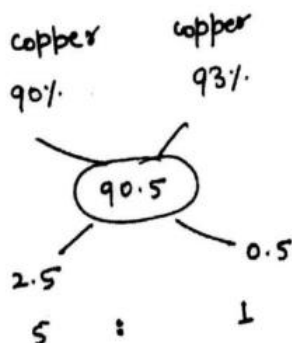
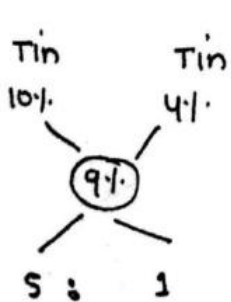

$$93 - 90 = 3$$

$$\begin{array}{c} 3 \\ \swarrow \quad \searrow \\ 5 : 1 \\ 2.5 \quad 0.5 \end{array}$$

⑦ Two varieties of milk with different prices is mixed in the ratio 2:3. The price of 1st type of milk is Rs 10 per litre while the price of 2nd type of milk is 15 Rs/litre. The average price of the mixture is:

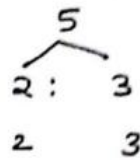
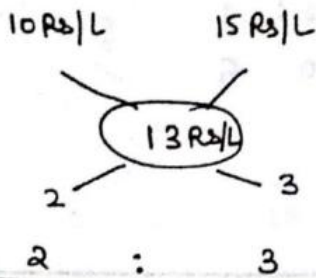

⑧ 5 kg of superior quality of rice is mixed with 25 kg of inferior quality rice. The price of superior quality & inferior quality rice is Rs 18 & Rs 12 respectively. The avg price per kg of the mixture is:

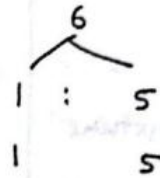
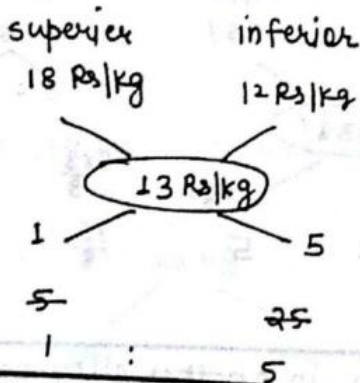

⑨ Bhunesh travels 30 minutes at the speed of 25 km/hr. Further he travels 20 minutes at the speed of 40 km/hr. Find his avg. speed.

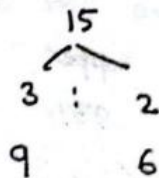
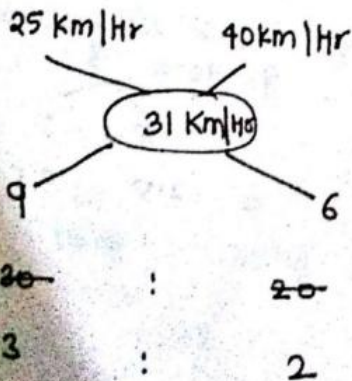

10) Bhuvnesh covered 150 km distance in 10 hours. The 1st part of his journey he covered by car, then he hired a rickshaw. The speed of car & rickshaw is 20 km/hr and 12 km/hr respectively. The ratio of distance covered by car & the rickshaw respectively are:

car Rickshaw
20 km/hr 12 km/hr

$$\frac{150}{10} = 15 \text{ km/hr}$$



3 : 5 (Time ratio)

C	R
20×3	12×5
60	60
1	1

11) A milkman has two type of milk. In the 1st container the % of milk is 80% and in the 2nd container the percentage of milk is 60%. If he mixes 28 litres of the ^{milk of} first container to the 32 litre of milk of the 2nd container, then the % of milk in the mixture is:

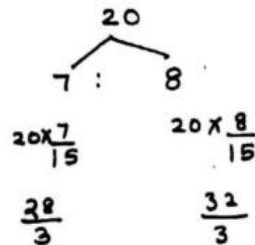
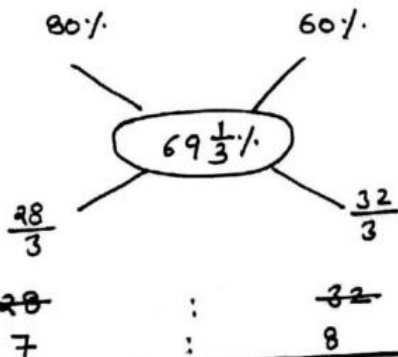

12) A sum of Rs 41 was divided 50 student. If each boy get 90 Paise & each girl get 65 paise. Find the no. of boys.

Boy Girl
90 P 65 P

$$\frac{4100}{50} = 82 \text{ P}$$

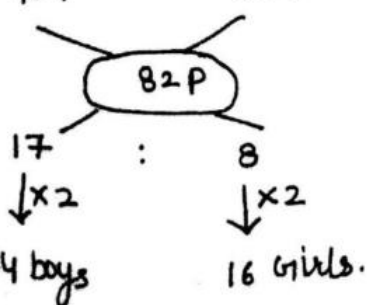

$$17 + 8 = 25 \rightarrow 50$$

$$1 \rightarrow 2$$

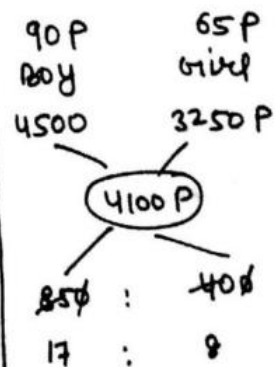

13) A sum of Rs ~~34.60~~ 26.90 is made up of 90 coins that are either 20 paise coins or 50 paise coins. find out how many 20 paise coins are there in the total amount.

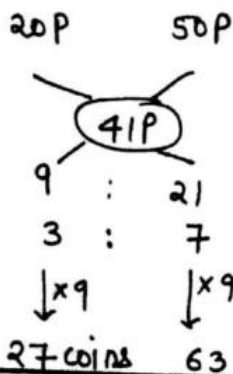

$$\begin{array}{r} 41 \\ \underline{3690} \\ 90 \end{array}$$

$$\begin{array}{l} 10 \rightarrow 90 \\ 1 \rightarrow 9 \end{array}$$

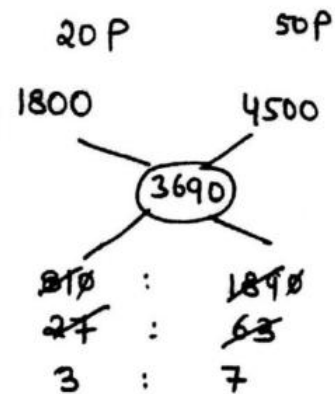

27 coins 63 coins.

14) Rs 69 were divided among 115 students so that each girl gets 50 paise less than a boy. Thus each boy received twice the paise as each girl received. The no. of girls in the class is ;

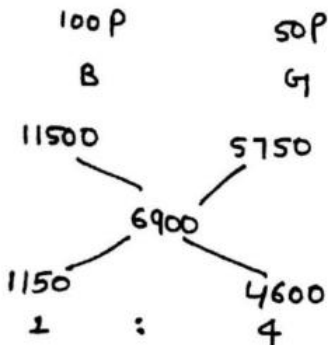

$$\begin{array}{l} B \quad G \\ 2x \quad x \\ 2x - x = 50 \\ x = 50 \end{array}$$

$$\begin{array}{l} 14 \Rightarrow 5 \rightarrow 115 \\ 1 \rightarrow 23 \\ \text{No. of Girls} \rightarrow 23 \times 4 = 92 \end{array}$$

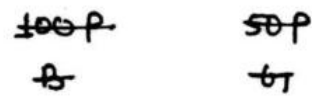

15) A student get +3 marks for each right answer and -0.5 mark for each wrong answer in an exam consists of 250 questions. If the students gets 477 marks in the exam, find the no. of wrong questions attempted by student.

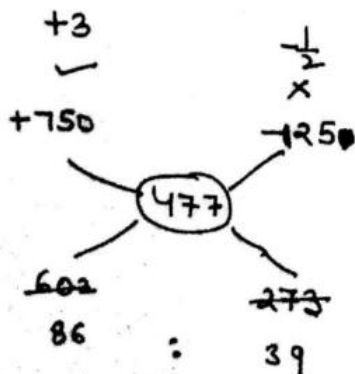

$$\begin{array}{l} 86 + 39 \\ = 125 \rightarrow 250 \\ 1 \rightarrow 2 \\ \text{wrong Ques} = \\ 39 \times 2 = 78 \end{array}$$

16) In the centre of a square room of side 10 metre, there is a square carpet and the rest of the floor is covered with cloth. If the cost of covering the full floor is 1338.50 Rs and the price of carpet and cloth is 15 Rs/m² and 6.50 Rs/m² respectively. find the width of the cloth border.

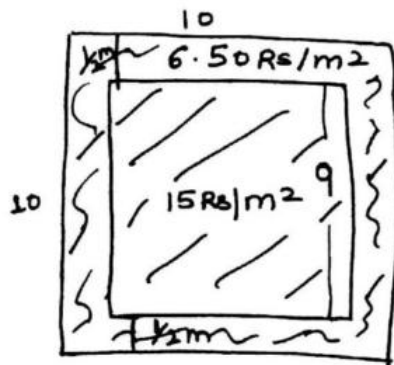

Area = 100 m²

<u>Carpet</u>	<u>Cloth</u>
15 Rs/m ²	6.50 Rs/m ²

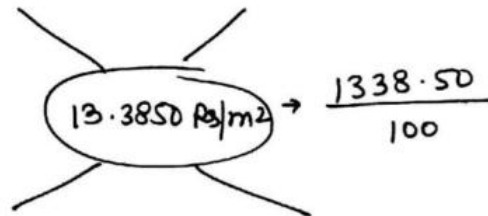

Carpet area = 81 m²

Carpet side = 9 m

width of cloth = 10 - 9 = 1 m

$\frac{1}{2}$ m (both side)

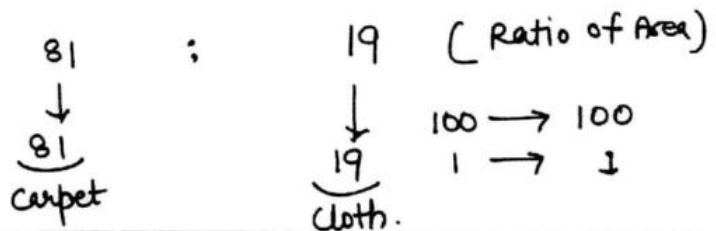

17) In a Delhi zoo, there are deers & ducks. if the heads are counted there are 180 while the legs are 448. What will be the no. of deers in the zoo.

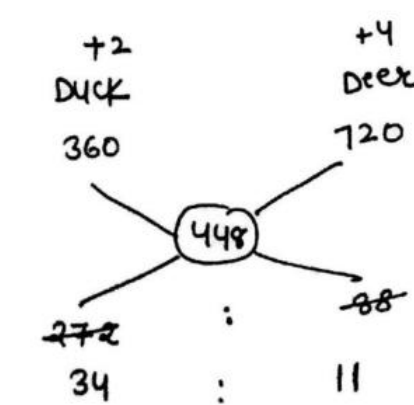

By:
Pardeep Chhokker
7206446517

34:11 → 45 → 180
1 → 4

(Ratio of animals)
No. of deers =
11 × 4 = 44 Ans

(18) In a MCD parking there are some two wheelers & rest are four wheelers. if wheels are counted, there are total 520 wheels but the incharge of the parking told me that 176 there are only 175 vehicles. if no vehicle has a stepney then the no. of two wheelers is :

2 wheelers 4 wheelers

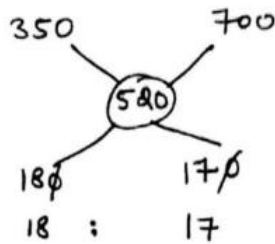

$$35 \rightarrow 175$$

$$1 \rightarrow 5$$

No. of two wheelers = $18 \times 5 \Rightarrow 90$ Ans

(19) In my pocket there are Rs 25 consisting of only the denominations of 20 paise & 50 paise. Thus there are total 80 coins in my pocket. The no. of coins of the denomination of 50 paise is :

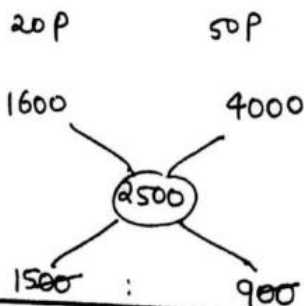

$$15 + 9 \Rightarrow 24 \rightarrow 80$$

$$1 \rightarrow \frac{80}{24} = \frac{10}{3}$$

No. of 50P coins =

$$3 \times \frac{10}{3} = 30 \text{ coins } \underline{\text{Ans}}$$

(20) Rakesh yadav reader publication sold the 20% books at the profit of 50% and 70% books at the profit of 10%. The avg profit percent of the publication shop is, if it sells only these two kinds of books.

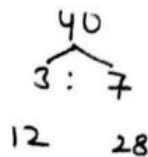
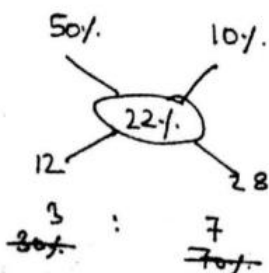

(21) A bus agency has 108 buses. He sold some buses at 9% profit and rest at 36% profit. Thus he gains 17% on the sale of all his buses. The no. of buses sold at 36% P is :

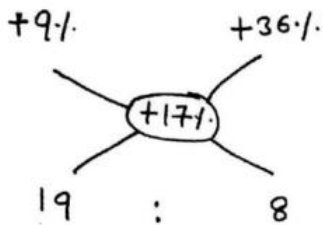

$$\begin{array}{r} 27 \text{ --- } 108 \\ 1 \text{ --- } 4 \end{array}$$



No. of Buses sold at 36% profit =
 $8 \times 4 = 32$

(22) A man purchased a pen & book for Rs 1300. He sold the pen at a profit of 20% and the book at a profit of 25%. In this way, his total profit was $23\frac{1}{13}\%$. find the CP of book.

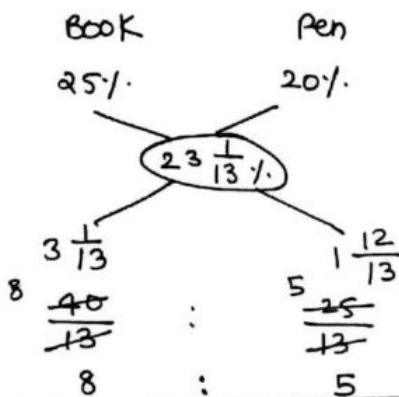

$$\begin{array}{r} 13 \text{ --- } 1300 \\ 1 \text{ --- } 100 \end{array}$$

cost price of Book = $8 \times 100 = 800$

(23) How many kg of sugar worth Rs 3.60 per kg should be mixed with 8 kg of sugar worth Rs 4.20 per kg such that by selling the mixture at Rs 4.40 per kg, there may be a gain of 10%.

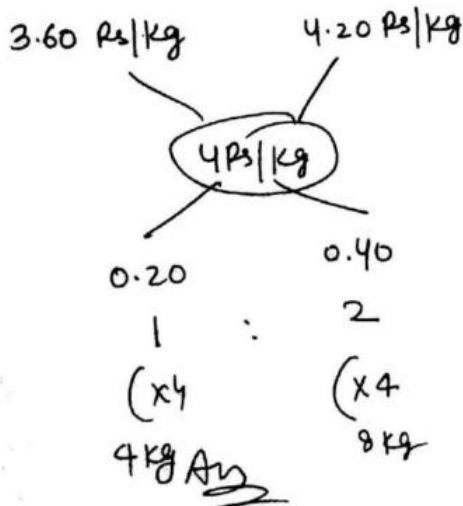

$10\% = \frac{1}{10}$
 $SP = 4.40 \text{ Rs/kg} \xleftarrow{\times 0.4} 11$

$CP = 4.00 \text{ Rs/kg} \xleftarrow{\times 0.4} 10$

24) A shopkeeper purchased two qualities of pulses at the rate of ¹⁷⁸ 200 Rs per quintal and Rs 260 per quintal. In 52 quintal of the 2nd quality, how much pulse of the 1st quality should be mixed so that by selling the resulting mixture at Rs 300 per quintal, he gains a profit of 25%.

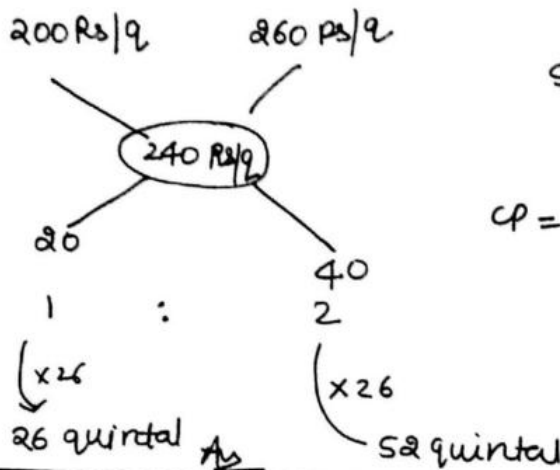

$$SP = 300$$

$$\begin{array}{r} 5 \text{ --- } 300 \\ 1 \text{ --- } 60 \end{array}$$

$$CP = 4 \times 60 = 240$$

$$\begin{array}{r} +1 - P \\ 4 - CP \\ SP = 5 \end{array}$$



25) A man purchased 5 Horses and 10 cows of Rs 10,000. He sells the horse at 15% P and cow at 10% Loss. Find the cost of each horse if he earns a profit of 375.

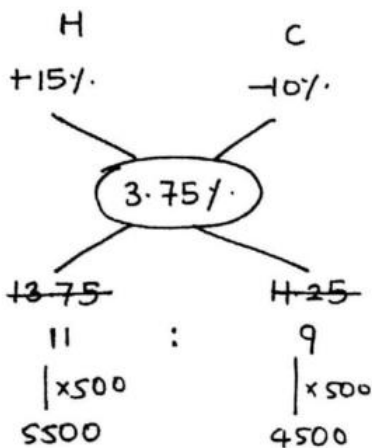

$$P\% = \frac{375}{10,000} \times 100$$

$$= 3.75\%$$

$$11H = 20 \text{ --- } 10,000$$

$$1 \text{ --- } 500$$

$$CP \text{ of 1 Horse} = \frac{5500}{5} = 1100$$

$$CP \text{ of 1 cow} = \frac{4500}{10} = 450$$

26) 20 pens and 16 pencils are purchased by a man for Rs 360. He sold the pens at 25% P and pencils at $\frac{7}{5}$ of its cost price. Find the price of each pencil, if he earns profit of Rs 120 at the end:

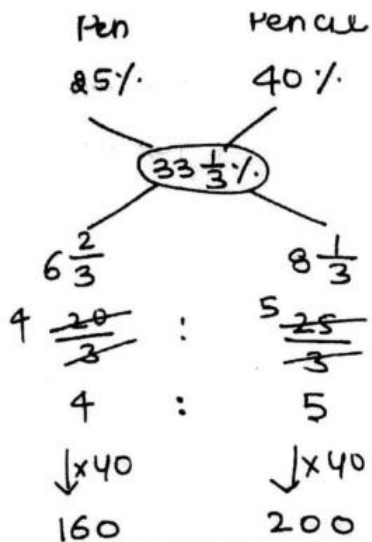

$$\frac{1}{5} \rightarrow 1 \quad \frac{2}{5} \times 100 = 40\% \quad P \quad 179$$

$$P\% = \frac{120}{360} \times 100$$

$$4+5 = 9 \rightarrow 360$$

$$1 \rightarrow 40$$



$$\text{Price of 1 pencil} = \frac{200}{16}$$

$$= 12.50 \text{ Rs}$$

Q7) A man purchased two chairs in Rs 900, he sells the 1st chair at $\frac{4}{5}$ of its cost price while the 2nd chair is sold at $\frac{5}{4}$ of its cost price. if during the whole transaction he earns a profit of 90 Rs, find the cost price of cheaper chair.

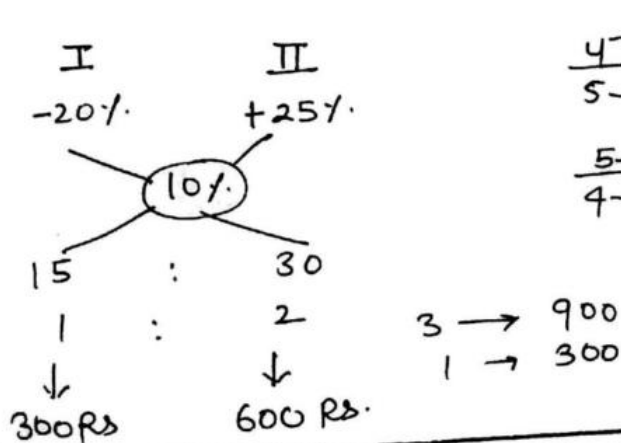

$$\frac{4}{5} \text{ SP} \quad \frac{-1}{5} \times 100 = -20\%$$

$$\frac{5}{4} \text{ SP} \quad \frac{+1}{4} \times 100 = +25\%$$

$$P\% = \frac{90}{900} \times 100 = 10\%$$

Q8) A mixture of sugar is sold at Rs 3.00 per kg. This mix. is formed by mixing the sugar of Rs 2.10 and Rs 2.52 per kg. What is the ratio of cheaper to the costlier quality in the mixture if profit of 25% is earned?

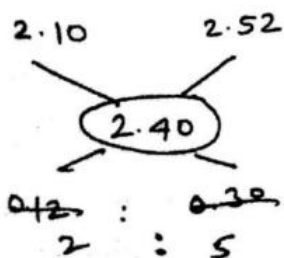

$$\frac{+1}{4} \text{ CP}$$

$$\text{SP} \rightarrow 5 \rightarrow 3$$

$$1 \rightarrow \frac{3}{5}$$

$$4 \rightarrow \frac{3}{5} \times 4 = 2.4$$

Ans

(29) Prakash Yadav sells two types of books viz national books and international books. He sells national books at Rs 18 per book and incurs a loss of 10%. whereas on selling the international books at Rs 30 per book, he gains 20%. In what proportion should the national books and international books be mixed such that he can gain a profit of 25% by selling the combined books at 27.5 Rs per book.

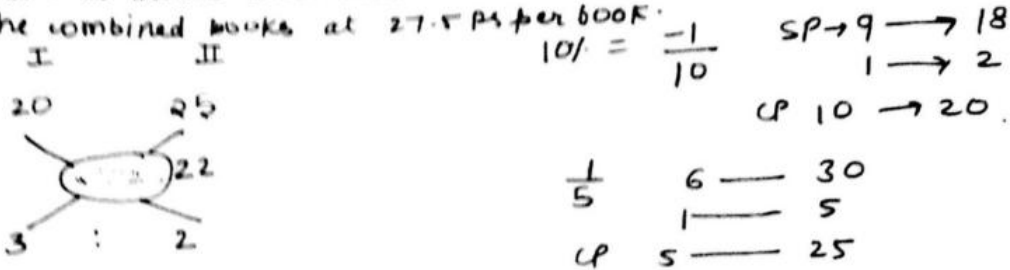

$SP = 27.50 \leftarrow \frac{4 \times 5 \times 5}{5}$

$CP = 4 \times 5 \times 5 = 22$

(30) A milkman has 20 litres of milk. if he mixes 5 litres of water, w/c is freely available in 20 litres of pure milk. If the cost of pure milk is Rs 18 per litre, then the profit of the milkman when he sells all the mixture at cost price, is :

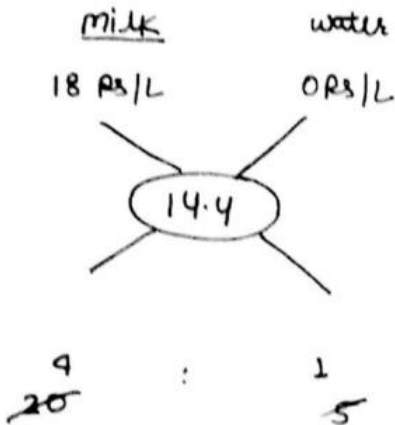

$18 - 0 = \frac{18}{4:1}$

$18 \times \frac{4}{5} = \frac{72}{5}$

$18 \times \frac{1}{5}$

14.4

$SP \rightarrow 18$
 $CP \rightarrow 14.4$) + 3.6

$\frac{3.6}{14.4} \times 100 = 25\% P.$

(31) In what ratio should water and soda be mixed that after selling the mixture at the cost price at profit of 33.33% is made?

- 35) Two vessels contain milk & water. In 1st vessel milk is 90% and in 2nd vessel milk is 40%. In what ratio should be mix both these vessels to obtain a new mixture w/c contain 70% milk.

182

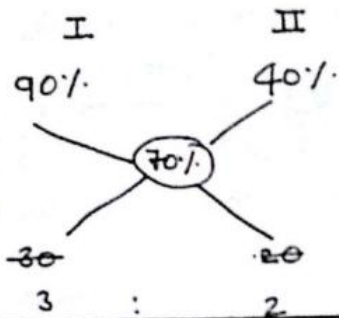

- 36) Two vessel contain milk and water in the ratio 9:1 and 2:3. In what ratio should both vessel is mixed w/c contain milk & water in the ratio 7:3.

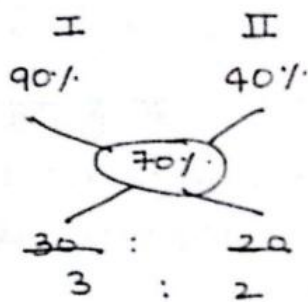

$$\frac{9}{10} \times 100 = 90\%$$

$$\frac{2}{5} = 40\%$$

$$\frac{7}{10} = 70\%$$

OR

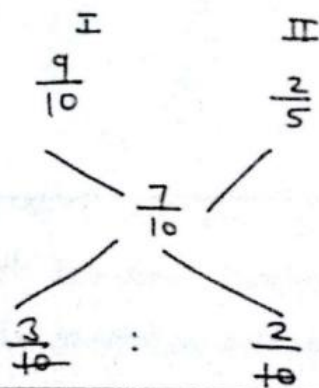

- 37) The ratio of water and wine in two diff. containers is 2:3 and 4:5. In what ratio we are required to mix the mixture of two containers in order to get the new mixture in w/c the ratio of wine and water be 7:5.

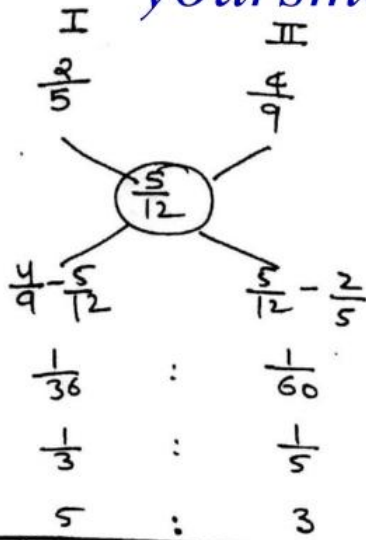

38) Two vessels contain spirit and water respectively in the ratio 1:3 and 2:5. find the ratio in w/c they are to be mixed to get a new mixture in w/c the ratio of spirit to water is 1:2

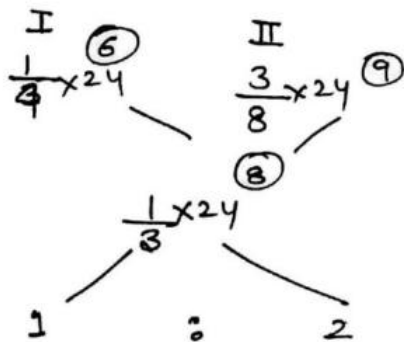

39) Two vessels contain a mixture of milk and water. In the 1st vessel the ratio of milk to water is 8:3 and in 2nd vessel the ratio is 5:1. A 35 L cask is filled from these vessels so as to contain a mixture of milk and water in the ratio of 4:1. How many litres are taken from the 1st vessel.

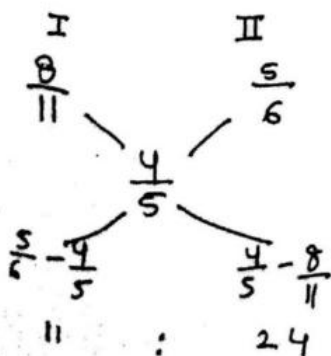

$$11 + 24 \rightarrow 35 \rightarrow 35$$

$$1 \rightarrow 1$$

11 Ltr - I

24 Ltr - II

40) Rakesh yadav purchased two diff kinds of alcohol. in the first mixture the ratio of alcohol to water is 3:4 and in the 184 2nd mixture it is 5:6. If he mixes the two given mixture and makes a third mixture of 18 litre in w/c the ratio of alcohol to water is 4:5. The quantity of first mixture is required to make the 18 litres of the 3rd kind of the mixture is

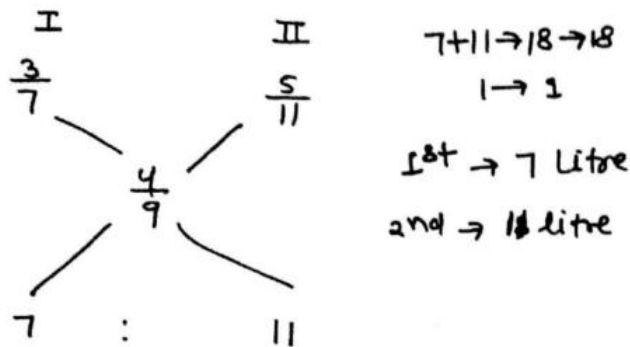

CLASS:

24

41) A mixture of water & milk contains 80% milk. In 50L of such a mixture, how many litres of water is required to increase the % of water to 50%?

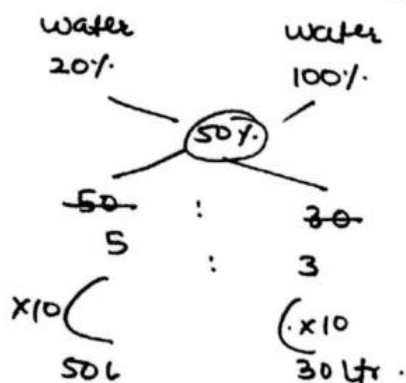

42) In 85L mix. of milk & water, water is only 20%. How many litres of water is required to ↑ the % of water to 90%?

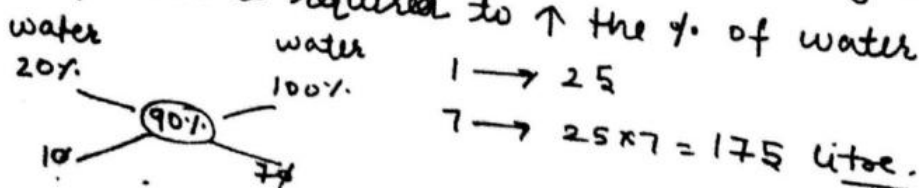

(43) A mix of 125 gallons of wine & water contains 20% wine. How much wine must be added to mix. in order to ↑ the % of wine to 25% of the new mixture? 185

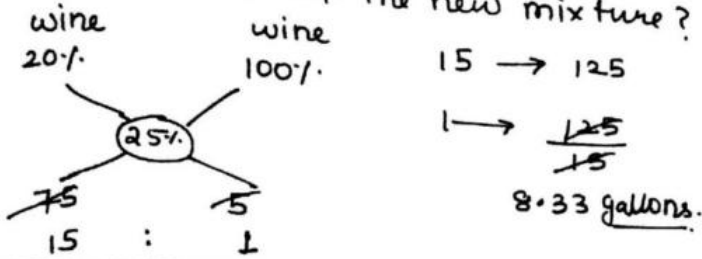

(44) A mix of 20L of milk & water contains ~~44%~~ 10% water. How much water should be added to it to ↑ the % of water to 25%.

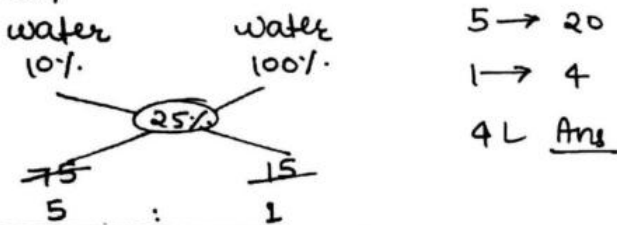

(45) In the 75 litre of mix of soda & water, ratio of soda & water is 4:1. The quantity of water required to make the ratio of soda & water 3:1 is :

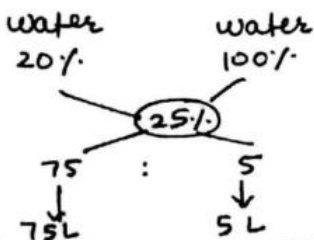

(46) The quantity of mix of milk & water is 70 L. This mix contains 10% water. How many litres of water should be mixed in the mixture to make 25% water in the mixture.

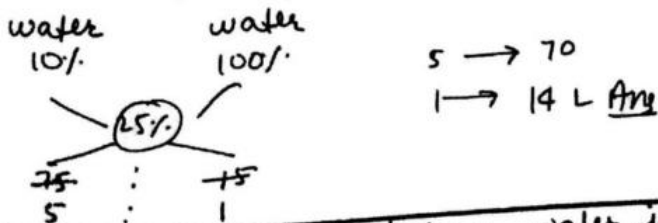

(47) In 50 L of water & milk mixture, water is 20%. The milk man gives 10 L of this mix. to a customer and then he adds up 10 L of pure water in the remaining mix. The % of water in the final mix is -

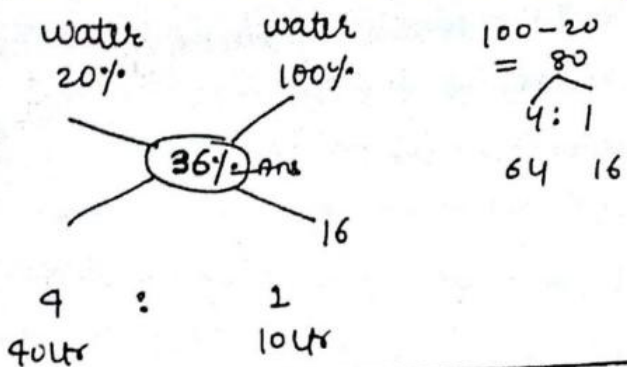

48) The diluted alcohol contains 8 L of alcohol and the rest is water. A new mix is w/c concentration of alcohol is 30% is to be formed by replacing diluted alcohol. How many litres of mixture shall be replaced with pure alcohol if there was initially 32 L of water in the mixture.

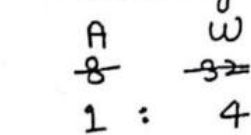

$A = \frac{1}{5} = 20\%$

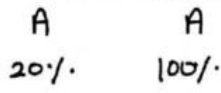

$7+1 = 8 \rightarrow 40$
 $1 \rightarrow 5$

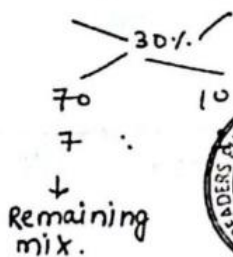

5 litre pure alcohol is added.



49) In a mix of milk & water, there is only 26% water. After replacing the mixture with 7 litres of pure milk, the % of milk in the mix becomes 76%. The quantity of mixture is

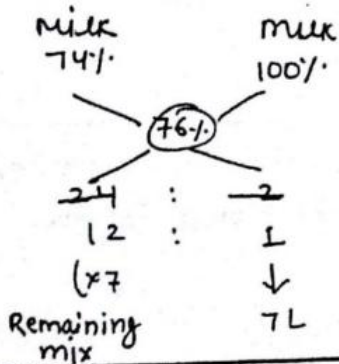

$12 \rightarrow 12 \times 7 = 84$

$\text{mix} = 84 + 7 = 91 \text{ L}$

50) The ratio of oil & kerosene in the container is 3:2 when 10L of mixture is taken out and replaced by kerosene, the ratio becomes 2:3. The total quantity of the mixture in the container is

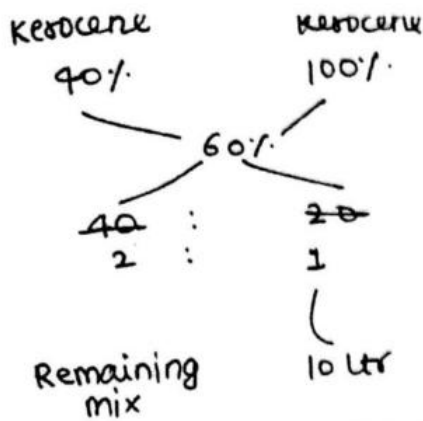

Total mix = 2+1 = 3

1 → 10
3 → 30 L

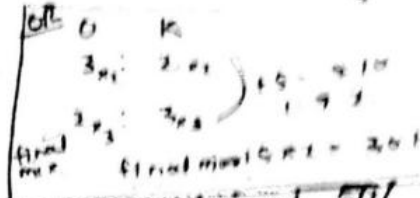

187
 $x = \frac{1}{2} = 50\%$
 $x = \frac{1}{2} = 50\%$

51) A bar tender stole beer from a bottle that contained 50% of spirit and he replaced what he had stolen with beer having 20% spirit. The bottle then contained only 25% spirit. How much of the bottle did he steal.

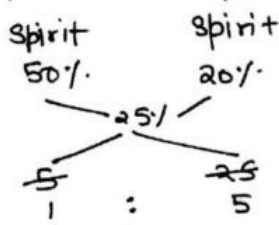

mix = 1+5 = 6
 stole → 5 Ltr.
 $\Rightarrow \frac{5}{6} \times 100$
 $= 83.33\%$



52) A butler stole wine from shop containing 50% spirit, then he replenished it by dist wine containing 20% spirit. Thus there was only 30% spirit in the new mixture. How much of the original wine did he steal?

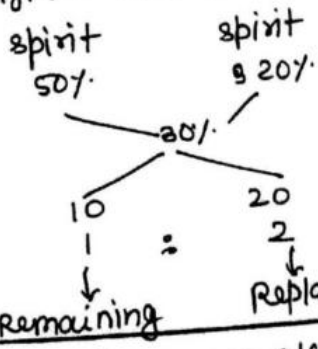

mix = 1+2 = 3
 Replaced = stolen
 stolen = $\frac{2}{3}$

53) In wine 40% alcohol & rest is water. Some quantity of wine taken out is replaced with same quantity of another wine containing 25% alcohol. Now the bottle contains 30% alcohol. Find what part of wine was taken out from bottle?

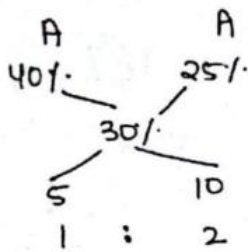

$mix = 1+2 = 3$
 $Replaced = \frac{2}{3}$

Remaining Replaced

54) In a wine 32% spirit, some quantity taken out and replaced with another type that contains 18% spirit. Now the spirit in the bottle is 28%. find what part of the wine is taken out?

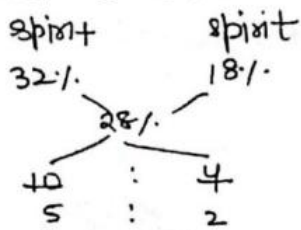

$Taken\ out = \frac{2}{7} \text{ Ans}$

Remaining Replaced

55) A vessel is full of 80 L milk, 8 L taken out & replaced by water. Again 8 L taken out and replaced by water. find the amount of milk in the final mixture so formed.

$Final\ quantity = Initial\ quantity \left(1 - \frac{x}{c}\right)^n$
 $c \rightarrow$ capacity of vessel
 $x \rightarrow$ quantity taken out at a time
 $n \rightarrow$ no. of process.

$final\ quantity = 80 \left(1 - \frac{8}{80}\right)^2$
 $= 80 \times \frac{9}{10} \times \frac{9}{10}$
 $= 64.8\ L$

(6) A 25L cylinder contains mix of oxygen & nitrogen. m
 ife oxygen is 36% of the mixture. some litres of the
 mix is taken out and replaced by nitrogen and this
 process is repeated one more time. At the end oxygen
 remained 9% of the mixture, find the quantity of
 mixture taken out at a time.

$$\frac{9}{100} = \frac{36}{100} \left(1 - \frac{x}{25}\right)^2$$

square both sides

$$1 = 2 \left(1 - \frac{x}{25}\right)$$

$$x = 12.5 \text{ litre.}$$

BY:
 Pardeep Chhoker
 7206446517

(57) From the 50L of pure milk, 5L of milk is taken out
 and 5 L water is added. this processes is repeated
 3 times, the amount of milk left after the 3rd replacement

$$\begin{aligned} \text{Final Q} &= 50 \left(1 - \frac{5}{50}\right)^3 \\ &= 50 \times \frac{9}{10} \times \frac{9}{10} \times \frac{9}{10} = \frac{9 \times 9 \times 9}{20} = 36.45 \text{ L} \end{aligned}$$

(58) From a 200L tank of petrol, the seller replaces each time
 with kerosene when he sells 40 litres of petrol (or its
 mixture). Every time he sells out only 40L of petrol (pure
 or impure). After replacing the petrol with kerosene 4th time
 the total amount of kerosene in the mix is →

$$\begin{aligned} \text{final Q. of petrol} &= 200 \left(1 - \frac{40}{200}\right)^4 \\ &= 200 \times \frac{4}{5} \times \frac{4}{5} \times \frac{4}{5} \times \frac{4}{5} = 81.92 \text{ L} \end{aligned}$$

$$\begin{array}{r} \text{Kerosene} = 200 \\ - 81.92 \\ \hline 118.08 \text{ L} \end{array}$$

59) A jar is full of milk. A person draw out 20% of the milk from the jar and replaced it with sugar solution. He has repeated the same process 4 times and thus there 190 was only 512 gm of milk left in the jar, the rest part of the jar was filled with sugar soln. The initial amt. of the milk in the jar was :

$$512 = \text{initial} \left(1 - \frac{1}{5}\right)^4$$

$$\cancel{512}^2 = \text{initial} \times \frac{256}{625}$$

$$\text{initial milk} = 625 \times 2 = 1250 \text{ gm.}$$

60) A vessel is full of milk, 63 L. if 9 L of milk is taken out and replaced by same amt. of water and further 7 L mixture is taken out and replaced by same amt. of water then find at the end of 2nd process the amount of water in the mixture?

$$63 \left(1 - \frac{9}{63}\right) \left(1 - \frac{7}{63}\right)$$

$$63 \times \frac{6}{7} \times \frac{8}{9}$$

$$\text{final a. of milk} = 48 \text{ L}$$

$$\text{water} = 63 - 48 = 15 \text{ L}$$

61) A vessel is full of milk = 15 L of milk is taken out & replaced by water. this process is repeated once more. find the initial amt. of milk in the vessel if at the end the ratio of milk & water becomes 16:9.

$$16 = 25 \left(1 - \frac{15}{C}\right)^2$$

square root

$$4 = 5 \left(1 - \frac{15}{C}\right)$$

$$C = 75 \text{ Ltr}$$

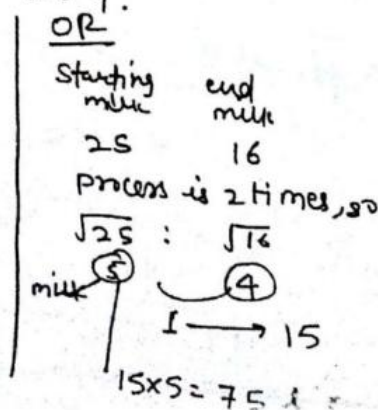

end m : w
16 : 9

mix → 25
means starting amt of 25 Ltr milk.

71(62) From a container of beer, a thief has stolen 15 litres of beer and replaced it with same quantity of water. He again repeated the same process. Thus in three attempts the ratio of beer and water became 343:169. The initial amount of beer in the container was :

Beer water
343 : 169

$343 + 169 = 512$ — Beer in starting

Starting Beer End Beer
512 : 343

3 process, so cube root

$\sqrt[3]{512}$ $\sqrt[3]{343}$

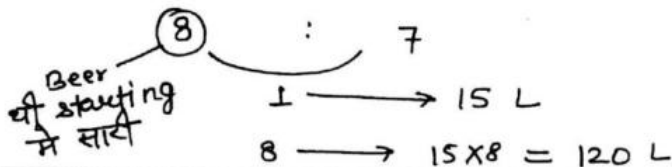

63) Some amount out of Rs 6000 was lent out at 10% per annum and the rest amount at 20% per annum and thus in 4 years the total interest from both the amounts collected was Rs 3400. What is the amount w/c was lent out @ 10% per annum ?

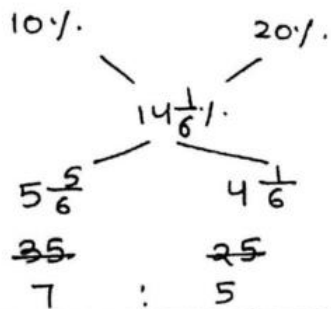

$\frac{6000 \times r \times 4}{100} = 3400$

$r = 14 \frac{1}{6} \%$

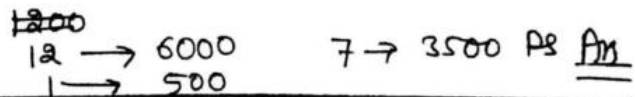

64) Two vessel contain a mixture of milk & water in ratio 1:2 and 2:3. if both vessel are mixed in ratio 1:1 then find the ratio of milk & water in new mixture.

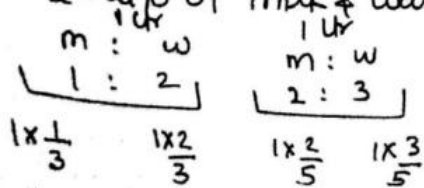

$m = \frac{1}{3} + \frac{2}{5} = \frac{11}{15}$

$w = \frac{2}{3} + \frac{3}{5} = \frac{19}{15}$

m:w = 11:19

$$A \quad \begin{array}{c} m \\ 1 \times 5 \end{array} : \begin{array}{c} w \\ 2 \times 5 \end{array} = 3 \times 5$$

$$B \quad \frac{2 \times 3}{11} : \frac{3 \times 3}{19} = 5 \times 3$$

CLASS
25

RATIO & PROPORTION

65) Two vessel contain milk & water in the ratio 7:5 and 7:9 if both vessel are mixed in ratio 1:1, find the ratio of milk and water in new mixture ?

$$A \quad \begin{array}{c} M \\ 7 \times 4 \end{array} : \begin{array}{c} W \\ 5 \times 4 \end{array} = 12 \times 4$$

$$B \quad \frac{7 \times 3}{44} : \frac{9 \times 3}{47} = 16 \times 3$$

66) Three vessel each of ~~10~~¹⁰ litre capacity contain a mixture of milk & water in the ratio 2:1, 3:1 and 3:2. if all the three vessels are emptied into a large vessel, find the ratio of milk & water in new mixture ?

$$A \quad \begin{array}{c} m \\ 2 \times 20 \end{array} : \begin{array}{c} w \\ 1 \times 20 \end{array} = 3 \times 20$$

$$B \quad 3 \times 15 : 2 \times 15 = 4 \times 15$$

$$C \quad \frac{3 \times 12}{121} : \frac{2 \times 12}{59} = 5 \times 12$$



67) Two vessel A & B contain a mixture of milk & water in the ratio 4:5 and 5:1. ~~In what ratio should quantities of mixture be taken &~~ If both vessel are mixed in the ratio 5:2 find the ratio of milk & water in new mixture.

$$A \quad \begin{array}{c} M \\ 4 \times 10 \end{array} : \begin{array}{c} W \\ 5 \times 10 \end{array} = 9 \times 2 = 18 \times 5$$

$$B \quad \frac{5 \times 6}{70} : \frac{1 \times 6}{56} = 6 \times 3 = 18 \times 2$$

$\Rightarrow 5:4$

$$A \quad \begin{array}{l} m \quad w \\ 1x5 : 2x5 = 3x5 \end{array}$$

$$B \quad \begin{array}{l} 2x3 : 3x3 = 5x3 \\ \hline 11 : 19 \end{array}$$

CLASS
25

RATIO & PROPORTION

65) Two vessel contain milk & water in the ratio 7:5 and 7:9 if both vessel are mixed in ratio 1:1, find the ratio of milk and water in new mixture?

$$M : W$$

$$A \quad 7x4 : 5x4 = 12x4$$

$$B \quad \begin{array}{l} 7x3 : 9x3 = 16x3 \\ \hline 44 : 47 \end{array}$$

66) Three vessel each of ~~10~~¹⁰ litre capacity contain a mixture of milk & water in the ratio 2:1, 3:1 and 3:2. if all the three vessels are emptied into a large vessel, find the ratio of milk & water in new mixture?

$$m : w$$

$$A \quad 2x20 : 1x20 = 3x20$$

$$B \quad 3x15 : 2x15 = 4x15$$

$$C \quad \begin{array}{l} 3x12 : 2x12 = 5x12 \\ \hline 121 : 59 \end{array}$$



67) Two vessel A & B contain a mixture of milk & water in the ratio 4:5 and 5:1. ~~In what ratio should quantities of mixture be taken~~ If both vessel are mixed in the ratio 5:2. find the ratio of milk & water in new mixture.

$$M : W$$

$$A \quad 4x10 : 5x10 = 9x2 = 18x5$$

$$B \quad \begin{array}{l} 5x6 : 1x6 = 6x3 = 18x2 \\ \hline 70 : 56 \Rightarrow 5:4 \end{array}$$

(68) If 2 kg of metal of w/c $\frac{1}{3}$ is zinc and rest is copper. 193
 We mixed with 3 kg of metal of w/c $\frac{1}{4}$ is zinc and rest is copper
 What is the ratio of zinc to copper in new mixture.

A $\frac{2}{1 \times 8} \quad \frac{c}{2 \times 8} = 3 \times 4 = 12 \times 2$ ^{2kg}

B $\frac{1 \times 9}{17} : \frac{3 \times 9}{43} = 4 \times 3 = 12 \times 3$ _{3kg}

(69) Ratio of Land : water on earth is 1:2 and ratio of
 Land: water in northern hemisphere is 2:3. find the ratio
 of Land:water in southern hemisphere.

Earth $\frac{L}{1 \times 10} : \frac{W}{2 \times 10} = 3 \times 5 = 15 \times 2$ ^{Earth}
 NH $\frac{2 \times 3}{4} : \frac{3 \times 3}{11} = 5 \times 3 = 15 \times 1$ _{NH}
 SH. $4 : 11$

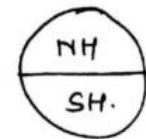

Earth $\rightarrow 2$
 NH $\rightarrow 1$

Earth: NH = 2:1

(70) Rs 5600 is to be divided among A, B, C & D in such a
 way that the ratio of share of A:B is 1:2, B:C is
 3:1, C:D is 2:3. find share of (A+B)

a : b : c : d
 1 : 2 : 2 : 2
 3 : 3 : 1 : 1
 2 : 2 : 2 : 3
~~6 : 12 : 4 : 6~~
 3 : 6 : 2 : 3



$3+6+2+3 = 14$
 $14 \text{ --- } 5600$
 $1 \text{ --- } 400$

(A+B) = 9×400
 = 3600 Rs.

(71) The ratio of expenditure of A, B and C is 16:12:9
 and their total income is 1530. find the share of B's
 income. if they save 20%, 25% and 40% of their income?

A B C
 Income $\rightarrow 20 : 16 : 15$
 Exp $\rightarrow 16 : 12 : 9$
 $51 \rightarrow 1530$
 $1 \rightarrow 30$
 $B = 16 \times 30 = 480 \text{ Rs.}$

$20\% = \frac{1}{5}$
 $E = 4 \rightarrow 16$
 $1 \rightarrow 4$
 $5 \rightarrow 20$

72) The total income of A, B & C is Rs 6000. A spends 80%, B spends 85% and C spends 75%, and the ratio of their saving is 5:6:9. find the income of A. 194

	A	B	C	$80\% = \frac{4}{5} \rightarrow 6$	$85\% = \frac{17}{20}$
Saving	5	6	9	$5 = 3 \rightarrow 6$	$1 \rightarrow 2$
Income	25	40	36	$6 \rightarrow 1$	$20 \rightarrow 40$
				$5 \rightarrow 25$	

$$101 \rightarrow 6060$$

$$1 \rightarrow 60$$

$$A = 25 \times 60 = 1500 \text{ Rs.}$$

73) Rs 2366 is divided among 8 men, 10 women & 10 children. Each man gets 25% more than each woman and each woman gets 25% more than each child. find the amount received by each woman.

m	w	c
5	4	4
5	5	4
25	20	16
$\times 8$	$\times 10$	$\times 10$
200	200	160
5	5	4

$$14 \rightarrow 2366$$

$$1 \rightarrow 169$$

$$5 \rightarrow 169 \times 5 = 845$$

$$\text{Each woman} = \frac{845}{10} = 84.5$$

74) Rs 500 is divided among A, B, C in such a way that Rs 16 more $\frac{2}{5}$ of A's share, Rs 70 less than $\frac{3}{4}$ of B's share, and Rs 4 less than $\frac{3}{5}$ of C's share are equal. find B's share.

$$A \times \frac{2}{5} + 16 = B \times \frac{3}{4} - 70 = C \times \frac{3}{5} - 4 = 6K \quad \text{LCM of } 4, 5, 3 = 60$$

$$A = (6K - 16) \times \frac{5}{2} = B = (6K + 70) \times \frac{4}{3} = C = (6K + 4) \times \frac{5}{3}$$

$$A = 15K - 40 \quad B = 8K + \frac{280}{3} \quad C = 10K + \frac{20}{3}$$

$$\therefore 15K - 40 + 8K + \frac{280}{3} + 10K + \frac{20}{3} = 500$$

$$33K = 440$$

$$K = \frac{40}{3}$$

$$B = 8 \times \frac{40}{3} + \frac{280}{3}$$

$$= \frac{600}{3} = 200 \text{ Rs}$$

(75) A boy and a girl playing with the pencil. The girl breaks the pencil in two parts and the boy observe that the ratio of length of these two parts is same as the ratio of length of pencil to the larger part. find the ratio in which the girl breaks the pencil.

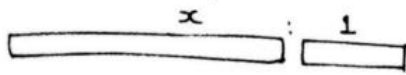

$$\frac{x}{1} = \frac{x+1}{x}$$

$$x^2 = x+1$$

$$x^2 - x - 1 = 0$$

$$x = \frac{-b \pm \sqrt{b^2 - 4ac}}{2a}$$

$$x = \frac{1 \pm \sqrt{5}}{2}$$

Ratio a:b नहीं ले सकते। 2 variable हो जायेंगे, Relation स्क्रिप्ट दिया है। So, x:1 मान लो।



$$x = \frac{1 + \sqrt{5}}{2} \Rightarrow \frac{\sqrt{5} + 1}{2}$$

∴ Ratio of two parts = $\sqrt{5} + 1 : 2$

(76) The ratio of income of A & B is 3 : 2 and ratio of their expenditure is 4 : 3. if they save Rs 2000 & Rs 900. find their income.

	A	B
I →	3x	2x
E →	4	3

$$\frac{3x - 2000}{2x - 900} = \frac{4}{3}$$

$$9x - 6000 = 8x - 3600$$

$$x = 2400$$

$$A = 7200 \text{ Rs}$$

$$B = 4800 \text{ Rs}$$

OR

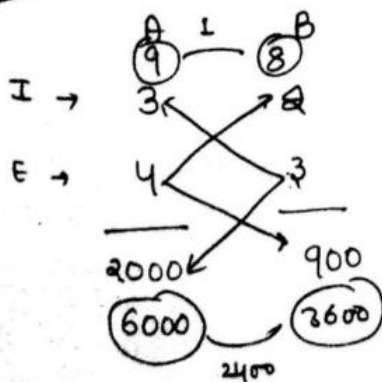

$$1 \rightarrow 2400$$

$$3 \rightarrow 7200 \text{ (A's income)}$$

$$2 \rightarrow 4800 \text{ (B's income)}$$

CLASS

26

7206446517.

Q22 The ratio of total amount distributed in all the male & female as salary is 6:5 while the ratio of salary of each male & each female is 2:3. find the ratio of no. of male & female?

	m	:	w
As	6	:	5
Each	2	:	3
	<u>3</u>	:	<u>5</u>
	9	:	5



Q23 430 is divided among 45 persons such that the ratio of total amt. received by all men, all women & all children are in the ratio 12:15:16. while the ratio of amount received by each man, each woman & each child is 6:5:4. Calculate the no. of man, woman & child and also find the amount received by each of them.

	m	:	w	:	c
total	12	:	15	:	16
Each	6	:	5	:	4
	<u>2</u>	:	<u>3</u>	:	<u>4</u>
no. of persons	10 men		15 women		20 child

9 → 45
1 → 5

12+15+16 = 43 → 430
1 → 10

All man = 120

Each man = $\frac{120}{10} = 12 \text{ Rs}$

All women = 150

Each woman = $\frac{150}{15} = 10 \text{ Rs}$

Each child = $\frac{160}{20} = 8 \text{ Rs}$

Q24 5625 is divided among A, B & C in such a way that A receives $\frac{1}{2}$ the sum of B & C. find the amount received by each. if B receives $\frac{1}{4}$ of (A+B).

$\frac{A}{B+C} = \frac{1}{2} = \frac{5}{10}$
 $\frac{B}{A+B} = \frac{1}{4} = \frac{3}{12}$

A : B : C
5 : 3 : 7

A+B → $\frac{375}{15} \times 8 = 3000 \text{ Rs}$

(80) The ratio of last year income of A, B & C is 3:4:5. while the ratio of their last year income to current year income 4:5, 2:3 and 3:4. if their total current year income is Rs 98500 find the present income of B+C.

197

$A : B : C$
 LYI $3 \times 12 : 4 \times 12 : 5 \times 12$
 $(36) : (48) : (60)$
 $\begin{matrix} \nearrow \times 9 \\ \text{L:C} \\ 4:5 \\ \downarrow \times 9 \\ 45 \end{matrix} \quad \begin{matrix} \nearrow \times 24 \\ \text{L:C} \\ 2:3 \\ \downarrow \times 24 \\ 72 \end{matrix} \quad \begin{matrix} \nearrow \times 20 \\ \text{L:C} \\ 3:4 \\ \downarrow \times 20 \\ 80 \end{matrix}$
 $LCM \text{ of } 2, 3, 4 \rightarrow 12$
 $45 + 72 + 80 = 197 \rightarrow 98500$
 $1 \rightarrow \frac{98500}{197} = 500$
 $B+C = 152 \times 500 = 76000 \text{ Rs.}$ Ans.



(81) one year ago the ratio of income of A & B is 3:5. The ratio of their LYI to CYI is 2:3 and 4:5. if their total CYI is Rs 4300. find their present income individually?

$A : B$
 Last Year Income $3 : 5$
 $\begin{matrix} \nearrow \text{(A)} \\ \text{L:C} \\ 2:3 \\ \downarrow \times 3 \\ 6 \end{matrix} \quad \begin{matrix} \nearrow \text{(B)} \\ \text{L:C} \\ 4:5 \\ \downarrow \times 5 \\ 20 \end{matrix}$
 $2 \text{ unit} \rightarrow 2$
 $1 \rightarrow \frac{3}{2}$
 $3 \rightarrow \frac{9}{2}$
 $4 \rightarrow 4$
 $1 \rightarrow \frac{5}{4}$
 $5 \rightarrow \frac{25}{4}$
 $CYI \quad A : B$
 $\frac{9}{2} : \frac{25}{4}$
 $18 : 25$
 $43 \rightarrow 4300 \quad A \rightarrow 1800 \text{ Rs}$
 $1 \rightarrow 100 \quad B \rightarrow 2500 \text{ Rs.}$

OR
 $A : B$
 LYI $3 \times 4 : 5 \times 4$
 $(12) : (20)$
 $\begin{matrix} \nearrow \text{(A)} \\ \text{L:C} \\ 2:3 \\ \downarrow \times 6 \\ 12 \end{matrix} \quad \begin{matrix} \nearrow \text{(B)} \\ \text{L:C} \\ 4:5 \\ \downarrow \times 5 \\ 20 \end{matrix}$
 $2 \rightarrow 12$
 $1 \rightarrow 6$
 $3 \rightarrow 18$
 $LCM \text{ of } 2, 4 = 4$
 $4 \rightarrow 20$
 $1 \rightarrow 5$
 $5 \rightarrow 25$
 $18 : 25$
 $A = 1800 \text{ Rs}$
 $B = 2500 \text{ Rs}$

(82) Ratio of income of A, B, C is 3:7:4 and the ratio of their exp. is 4:3:5. if A saves $14\frac{2}{7}\%$ of his income. find the ratio of their saving.

$$\begin{array}{l}
 A : B : C \\
 I \quad 3x : 7x : 4x \\
 E \quad 4y : 3y : 5y \\
 S \quad (3x-4y) : (7x-3y) : (4x-5y)
 \end{array}$$

$$14\frac{2}{7} \cdot \frac{1}{7} = \frac{1}{7} \begin{array}{l} S \\ I \end{array}, E = 6$$

$$\frac{3x}{4y} = \frac{7}{6}$$

$$\frac{x}{y} = \frac{14}{9}$$

$$S = (42-36) : (98-27) : (56-45)$$

$$6 : 71 : 11 \quad \text{Ans}$$

OR

	A	B	C	(A)
I	7	196	112	7
E	6	72	90	198
S	12	142	22	
	6	71	11	Ans

A का Income & Exp का ratio 7:6 करना है।

first convert in 1:1 and then in 7:6

(83) A dog chase a rabbit. The dog takes 6 leaps for every 7 leaps of the rabbit and the distance covered by rabbit in 6 leaps is equal to the distance covered by dog in 5 leaps. find the ratio of their speed.

Dog	Rabbit
6 jump	7 jump
6×6	7×5
$= 36$	$= 35$

Dog	Rabbit
5 jump	= 6 jump



(84) A dog takes 7 jumps for every 10 jumps of the lion and a fox takes 12 jumps for every 10 jumps of the lion. And the distance covered by dog in 5 jumps, distance covered by lion in 15 jumps and the distance covered by fox in 20 jumps is equal. find the ratio of their speeds.

Dog	lion	fox
7	10	12
$\times 12$	$\times 4$	$\times 3$
84	40	36

Dog	=	lion	=	fox
5 jump		15 jump		20 jump

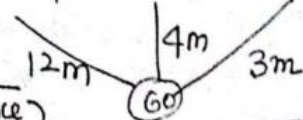

Ratio of the distance covered by two objects in same time is equal to the ratio of their speeds

$D = ST$

85) The price of Gold is directly proportional to square of its weight. A person broke down the Gold in the ratio of 3:2:1 and sold, incurs a loss of Rs 4620. find the initial price of Gold.

initial weight = $3+2+1 = 6$

$36-14 = 22$ for loss

initial price = $6^2 = 36$

$22 \rightarrow 4620$

$1 \rightarrow 210$

After breaking price = $3^2 + 2^2 + 1^2 = 14$

initial price = $36 \times 210 = 7560$ Rs. Ans.

CLASS

27

86) A is inversely proportional to the cube of B.

if $A=3$ then $B=2$

but if $A=\frac{8}{9}$ then $B=?$

$A \propto \frac{1}{B^3}$

$A = \frac{24}{B^3}$

$A = \frac{K}{B^3}$

$\frac{8}{9} = \frac{24^3}{B^3}$

$3 = \frac{K}{(2)^3}$

$B^3 = 27$

$B = 3$ Ans.

$K = 24$

BY.
Pardeep Chhoker
7206446517

87) A bag contain 1Rs, 50P & 25P coins and the ratio of no. of coins is 5:7:9. if the total value of all coins is 430 Rs. Then find the no. of 50P coins.

	1Rs	50P	25P
No. of coins	5	7	9
Ratio of value	5 Rs	3.50 Rs	2.25 Rs

$10.75 \text{ Rs} \rightarrow 430$

$1 \rightarrow \frac{430}{10.75} = 40$

No. of 50P coins = $7 \times 40 = 280$

88) A bag contains 1Rs, 50P & 25P coins and the ratio of their value is 30:11:7. and the total no. of coins are 480. find the no. of 50P coins.

	1Rs	50P	25P
value	30	11	7
coins	30	22	28

$80 \rightarrow 480$

$1 \rightarrow 6$

No. of 50P coins = $22 \times 6 = 132$ By

89) find the mean proportion of $\frac{1}{4}$ & $\frac{1}{9}$

$$\sqrt{\frac{1}{4} \times \frac{1}{9}} = \frac{1}{6}$$

mean proportion of
 $a, b = \sqrt{ab}$

90) find the 3rd proportion of 18, 36.

$$\frac{36 \times 36^2}{18} = 72$$

3rd proportion =
 $\frac{b^2}{a}$

91) find the 4th proportion of 12, 16, 18.

$$\frac{16 \times 18}{12} = 24$$

4th proportion of
 $a, b, c = \frac{bc}{a}$

92) Rs 710 is divided among A, B & C in such a way that A receives Rs 40 more than B, C receives Rs 30 more than A. find the share of A.

A	B	C
$x+40$	x	$x+70$

$A = 240$ Rs

$$3x + 110 = 710$$

$$3x = 600$$

$$x = 200$$



93) The ratio of age of Ram & shyam 5 years ago was 2:3 and the ratio of their age after 5 years would be 3:4 find the sum of their present ages.

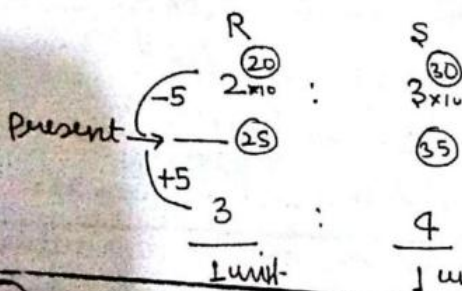

$$25 + 35 = 60$$

Ans.

94) The ratio of ages of Ram & shyam 5 years ago was 3:1 the ratio of their age after 5 year will be 2:1. find the present age of both.

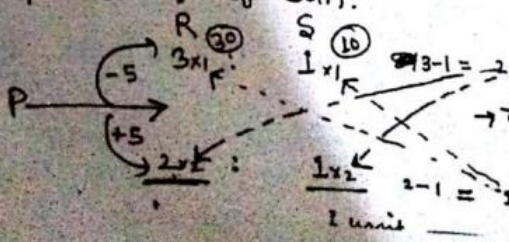

Present age of Ram = 35

Present age of Shyam = 15

दोनों की age का diff same करने के लिए

(25) The age of Ram is 4 times of his daughter. The age of 201 Ram was 9 times of her daughter five years ago. - find their present ages.

दोनों की age का diff same करने के लिए पहले दोनों का diff ले लेते हैं फिर cross multiply कर देते हैं

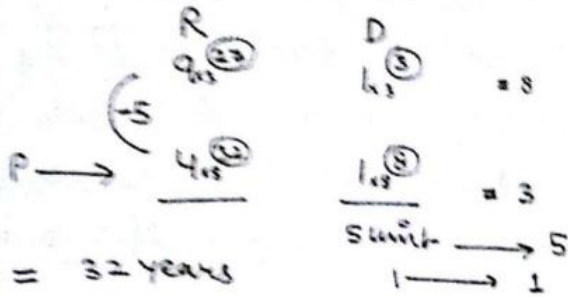

Ram = 32 years

daughter = 8 years.

(26) The age of father is 3 times of his son. 5 years before the age of son was $\frac{1}{6}$ times of his father. find the present age of son. At the time of ^{marriage of} his mother, she was 5 years younger to his father. find the age of mother.

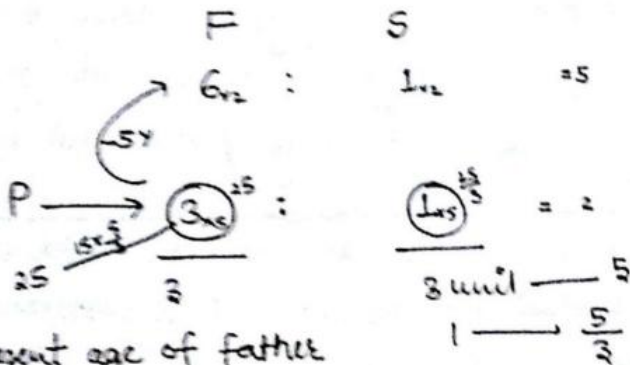

Present age of father = 25

Present age of son = $5 \times \frac{5}{3} = \frac{25}{3}$

Mother's age → ~~25~~ $25 - 5 = 20$



(27) The ratio of age of meena & her mother is 3:8. find the ratio of their age after 4 years. if after 20 years their age diff will be 35 years.

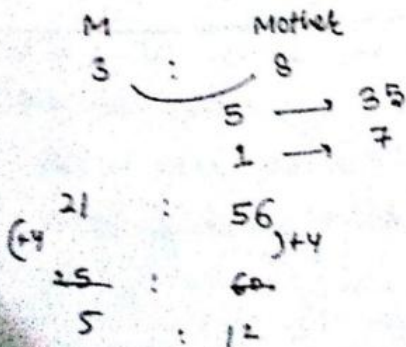

PARTNERSHIP

98) A & B are two partners start a business by investing a capital 25,000 Rs and 35,000 Rs. and decide to share their profit acc. to their capital. But C joins the business on a condition that they will distribute the profit equally (1:1:1) and for that C gives 2,20,000 to A & B. find in w/c ratio A & B will distribute that amount.

A : B : C
5 : 7 : 4

(1) 5 : (3) 7 : 4
4 : 4 : 4

A का 1 : 3 B का 2000.
अ 4 गवा c के पास

2,20,000
1 : 3

(A) 55,000 1,65,000 (B)

25000 : 35000
5 : 7
profit = 12
A 5 B 7

12
4 4 4



99) A & B start a partnership with Rs 1500 and Rs 2000. After 4 months C also joins the business with Rs 2250. if B withdraw his capital after 9 months then find the share of profit of B in a total profit of Rs 900.

A	B	C	
1500 x 12	2000 x 9	2250 x 8	3 → 900
1800	1800	1800	1 → 300
			B → 300

100) A & B start a business with Rs 50 and Rs 45. After 4 months A withdraw half of his capital and B withdraw half capital after 6 months and C joins the business with a capital of Rs 70 after 6 months. find the profit sharing ratio.

A	B	C
50x4	45x6	70x6
25x8	22.50x6	
400	405	420
80	81	84

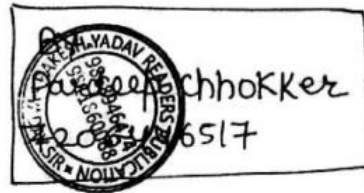

101) A & B start a business with Rs 15000 and 15000. After 3 months A withdraw Rs 5000 and B invest Rs 5000 more. C joined the business with Rs 21000 next after 3 months. If the total profit is 24,900, find the share of C.

A	B	C
16000x3	15000x3	21000x6
11000x9	20000x9	
147	225	126

$$\frac{498}{1} = \frac{24900}{50}$$

$$C = 126 \times 50 = 6300 \text{ Rs.}$$



102) A invest $\frac{1}{6}$ part of total capital for $\frac{1}{6}$ time. B invest $\frac{1}{3}$ part of total capital for $\frac{1}{3}$ time and C invest the rest capital for full time. If the total profit is Rs 23000, find the share of B.

Total capital = 6	A	B	C
	1x2	2x4	3x12
$\frac{1}{6} \times \frac{1}{6} = \frac{1}{36}$	2	8	36
$\frac{1}{3} \times \frac{1}{3} = \frac{1}{9}$	1	4	18

$$\frac{23}{1} = \frac{23000}{1000}$$

$$B = 4000$$

103) A & B start a business, A invest $\frac{1}{4}$ capital for $\frac{1}{4}$ th time and B invest $\frac{1}{5}$ th capital for $\frac{1}{5}$ time and C invest the remaining capital for full time. How should they divide a profit of Rs 1140.

A	B	C
5x3	4x5	11x24
5	8	44

$$\frac{57}{1} = \frac{1140}{20}$$

$$A \rightarrow 100$$

$$B \rightarrow 160$$

$$C \rightarrow 880$$

Ans

$$\frac{1}{4} \quad \frac{1}{5}$$

$$\text{Capital} = \text{LCM of } 4, 5 = 20$$

(104) A, B, C start a business by investing the capital in 5:6:8. At the end of the business they receive the profit in the ratio of 5:3:12. find the ratio of time for w/c they contribute their capital?

	A	:	B	:	C
P	5		3		12
C	5		6		8
T	$\frac{1 \times 2}{2}$		$\frac{1}{2} \times 2$		$\frac{3 \times 2}{2}$
	2	:	1	:	3

$$P = C \times T$$

$$T = \frac{P}{C}$$

$$C = \frac{P}{T}$$

Ans.

(105) A, B, C start a business, A invest money for 4 months & claim $\frac{1}{8}$ of the total profit & B invest money for 6 months & claim $\frac{1}{3}$ of the profit while C invest Rs 1560 for 8 months. How much money A & B invest?

	A	B	C
P	3	8	13
T	$\frac{4}{4}$	$\frac{6}{3}$	$\frac{8}{8}$
C	$\frac{3}{4} \times 24$	$\frac{4}{3} \times 24$	$\frac{13}{8} \times 24$
	18	32	39



$$\frac{1}{8} \quad \frac{1}{3}$$

$$P = 24 \text{ (LCM of 8, 3)}$$

$$39 \rightarrow 1560$$

$$1 \rightarrow 40$$

$$A \rightarrow 18 \times 40 = 720$$

$$B \rightarrow 32 \times 40 = 1280$$

(106) A & B rent a pasture for 10 months. A puts in 100 cows for 8 months. How many cows can B put in for the remaining two months if he pays $\frac{3}{2}$ as much as A.

$$A = 100 \times 8 = 200$$

$$B = C \times 2$$

$$100 \times 8 \times 3 = C \times 2 \times 10$$

$$C = 600$$

$$B = A \times \frac{3}{2}$$

$$\frac{B}{A} = \frac{3}{2}$$

107) A & B start a business with 50,000 & 20,000 Rs. If A is working partner and takes 20% of the total profit as his salary and remaining profit is divided acc. to their capital. If in this process A received Rs 38000 more than B. Find the amount of total profit?

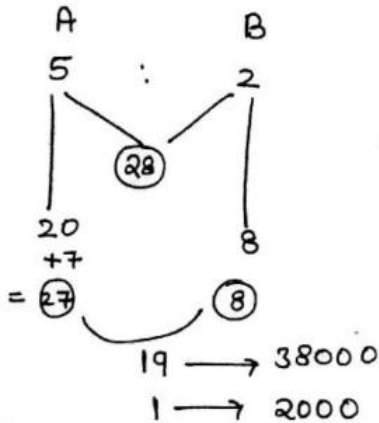

$$A = \frac{5}{7} \times 28 = 20$$

$$B = \frac{2}{7} \times 28 = 8$$

$$20\% = \frac{1}{5}$$

$$T.P = 5 \times 7$$

$$A's \text{ salary} = 1 \times 7$$

Profit to be distributed

$$= 4 \times 7 \rightarrow \text{multiply by 7 so that fraction is integer}$$

$$\text{Total Profit} = 35 = 35 \times 2000$$

$$= 70000 \text{ Rs } \underline{\underline{\text{Ans}}}$$

108) A, B, C are three partners with a capital 8,00,000, 12,00,000, 15,00,000 and they decide to share their profit acc. to the ratio of their capital. But A is working partner and takes $12\frac{1}{2}\%$ of total profit as salary. If A receives Rs 5200 from the business. Find the amount of total profit?

A	B	C
8	12	15
$\frac{8}{35} \times 35$	$\frac{12}{35} \times 35$	$\frac{15}{35} \times 35$
8	12	15
+5		
13		



$$12\frac{1}{2}\% = \frac{1 \times 5}{8 \times 5} \rightarrow \begin{matrix} A's \text{ salary} \\ T.P \end{matrix}$$

$$\text{Distributable P} = 7 \times 5$$

$$12 \rightarrow 5200$$

$$1 \rightarrow 400$$

$$\text{Total Profit} = 40 \times 400 = 16000 \text{ Rs } \underline{\underline{\text{Ans}}}$$

109) A & B are two partners with capital 50,000 & 70,000 and agreed that 70% of the total profit should be divided equally b/w them and the remaining profit in the ratio of their capital. If one partner gets Rs 90 more than other find the total profit?

115) A & B started a business with a capital of Rs 32,000 & Rs 56,000 & decide to share their profit acc. to their capital. But C join the business on a condition that they will ~~decided~~ ^{share} the profit equally & for that C gives 2,20,000 to A & B. Then find in what ratio A & B will distribute that amount. 208

A	:	B	C
4	:	7	
$\frac{11}{3}$		$\frac{11}{3}$	$\frac{11}{3}$
<hr style="width: 100%;"/>		<hr style="width: 100%;"/>	
$\frac{1}{3}$		$\frac{10}{3}$	
1	:	10	

$\frac{32000}{4} : \frac{56000}{7}$

P = 11

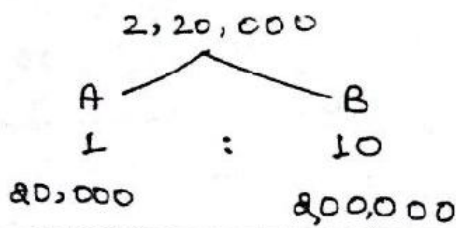
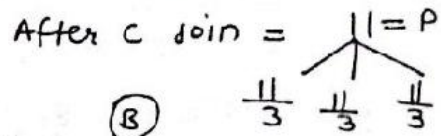

11 → 2,20,000
1 → 20,000



AVERAGE

#

84, 97, 53, 59, 79. let Avg = 60

+24	+37	-7	-1	+19	
					<u>+14.4</u>
					74.4 <u>Ans</u>

$$\frac{72}{5} = 14.4$$

① if the Avg score of 42 boys of a school is 137. while the avg score of 98 girls is 124 of the same class. find the combined average of the class.

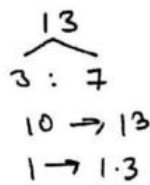
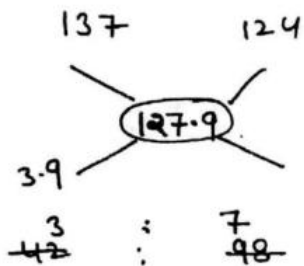

OR

137	124	(130)
(+7)	(-6)	+0.5
		$\Rightarrow 130.5$

$$\frac{1}{1} = +0.5$$

OR

42	98	
3	7	
137	124	let Avg = 130
+7x3	-6x7	= 130
21	-42	-2.1
		<u>127.9</u>
		<u>Ans</u>

$$-\frac{21}{10} = -2.1$$

#

4	:	3	:	2
129		137		124
-4		+21		-12

Avg = 130

$$130 + \frac{5}{9} = 130 \frac{5}{9}$$



#

No. of students	$\frac{39}{3}$:	$\frac{41}{7}$:	$\frac{52}{4}$	
Avg score	79		56		70	let Avg = 70
find avg score of All.	+7x3		-14x7		0	<u>-5.07</u>
	+27		-98			64.93
						<u>Ans</u>

$$\frac{-71}{14} = 5.07$$

	X	Y	Z
Students	27 3	26 4	45 5
Avg score	83	76	85
	+9	-16	+25
	$\frac{+18}{12} = +1.5$		

find avg of 3 classes

$$\begin{array}{r} \text{let avg} = 80 \\ + 1.5 \\ \hline 81.5 \text{ Ans} \end{array}$$

- ② The avg marks of the class X, Y, Z is calculated. The avg score of class X, Y, Z are 83, 76, 85. The avg score of class X & Y is 79 while the avg score of Y & Z is 81. Find the avg score of all the three classes.

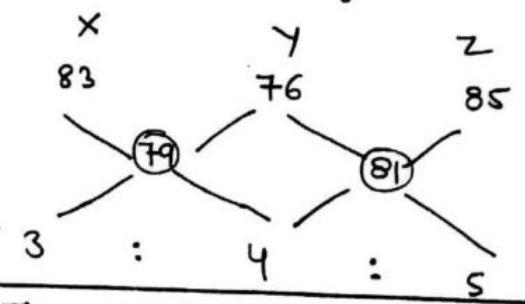

Avg of X, Y, Z = 81.5

(soln in above ques)

- ④ The avg of 9 observations is 87. if the avg of first five observations is 79 and the avg of next three is 92. find the 9th observation.

$$\frac{1-5}{79} \quad \frac{6-8}{92} \quad \text{---} = 87$$

87 x 9 = 783

$$\begin{array}{r} 79 \times 5 = 395 \\ 92 \times 3 = 276 \\ \hline 671 \end{array}$$

$$\begin{array}{r} -671 \\ \hline 112 \text{ Ans} \end{array}$$

OR

$$\begin{array}{r} \frac{1-5}{79} \quad \frac{6-8}{92} \quad \text{---} = 87 \\ -8 \times 5 \quad +5 \times 3 \\ -40 \quad +15 \\ \hline -25 \end{array}$$

87 + 25 = 112 Ans
(Avg से 25 कम है 9th no में +25 होगा)

$$\begin{array}{r} \frac{1 \dots 3}{110} \quad \frac{4 \dots 7}{130} \quad \dots = 117 \\ \downarrow \\ \frac{-21}{+31} \quad \frac{+52}{-31} \end{array}$$

5) The avg. of 7 data is 34 and the avg of first three data is 28 and the avg of next two data is 47. find the avg of last two data.

$$\begin{array}{r} \frac{1 \dots 3}{28} \quad \frac{4 \dots 5}{47} \quad \dots = 34 \\ \downarrow \\ \frac{-18}{+8} \quad \frac{+26}{-8} \quad \frac{-8}{2} = -4 \quad 34 - 4 = 30 \text{ Ans} \end{array}$$

6) The avg. age of 30 students of a class is 14 years 4 months. Due to admission of 5 new students the avg. becomes 13 years 9 months, while the age of the younger one in new 5 students is 9 years 11 months. find the avg of remaining four new students.

$$\begin{array}{r} \frac{\dots}{14-4} \quad \dots = 13-9 \\ \downarrow \\ \frac{7 \times 30}{\text{months}} \quad \frac{+210}{-210} = -42 \quad (-3 \cdot 6) \end{array}$$

$$\begin{array}{r} \frac{\dots}{10.3} \\ \downarrow \\ 10.4 \text{ Ans} \\ \frac{9-11}{4} = \frac{+4}{4} = +1 \end{array}$$

7) The avg of 9 data is 79. The avg of first 2 data is 75. if the avg of next four data is 87. if the 8th data is 5 more than 7th data and one more than 9th data. Calculate 9th observation.

$$\frac{75}{75} \quad \frac{87}{87} \quad \frac{71}{71} = 79$$

212

$$\begin{array}{r} -8 \\ +24 \\ \hline \end{array}$$

$$\frac{-24}{3} = -8$$

$$79 - 8 = 71$$

$$\begin{array}{ccc} 68 & 73 & 72 \\ \swarrow & \nearrow & \swarrow \\ 7^{\text{th}} & 8^{\text{th}} & 9^{\text{th}} \\ x & x+5 & x+4 \\ \hline & 71 & \end{array}$$

$$\Rightarrow 3x + 9 = 71 \times 3$$

$$x = 68$$

OR Avg = x

$$x + 3 = 71$$

$$x = 68$$

⑧ Avg. of 8 nos is 20. The avg of first two nos is 15.5 and the avg of next three nos is $21\frac{2}{3}$. If the 6th no. is 4 & 7 less by the 7th & 8th no. find the 8th no.

$$\frac{15.5}{15.5} \quad \frac{21\frac{2}{3}}{21\frac{2}{3}} \quad \frac{21\frac{2}{3}}{21\frac{2}{3}} = 20$$

$$\begin{array}{c} (-9) \quad (+4) \\ \hline -5 \end{array}$$

$$\frac{+5}{3} = 1\frac{2}{3}$$

$$\begin{array}{ccc} 6^{\text{th}} & 7^{\text{th}} & 8^{\text{th}} \\ x & x+4 & x+7 \end{array}$$

$$\frac{11}{3} = 3\frac{2}{3}$$

$$x + \frac{11}{3} = 21\frac{2}{3}$$

$$x = 18$$

8th = 25 Ans

CLASS
29

Pardeep Chhokker
7206446517

⑨ 9 girls and 1 boy go to a restaurant for lunch. If each girl spent Rs 30 and boy spent Rs 72,000 more than the avg of expenditure of all. find the amount spent by the boy?

$$\begin{array}{r} \text{Girls} \\ \downarrow \quad \downarrow \quad \downarrow \quad \downarrow \quad \downarrow \quad \downarrow \quad \downarrow \quad \downarrow \quad \downarrow \\ 30 \quad 30 \quad 30 \quad 30 \quad 30 \quad 30 \quad 30 \quad 30 \quad 30 \\ \hline + 8000 \\ \hline 8030 \end{array}$$

A → Avg.

$$\begin{array}{r} \text{Boy} \\ \downarrow \\ A + 72000 \\ \hline 9 \\ \hline A + 8000 \end{array}$$

$$\text{Boy} = 8030 + 72000$$

$$= 80030.$$

⑩ Five year ago the avg age of Husband & wife was 23 years. Today the avg age of Husband, wife & child is 20 years. How old is the child? 213

$$\begin{array}{r}
 \text{H} \quad \text{W} \quad \text{C} \quad = \quad 20 \\
 \hline
 \text{28} \quad \text{④} \\
 \hline
 +16 \quad \quad \quad -16
 \end{array}$$

⑪ 3 years ago the avg. of family of five members was 17 years. A baby having been born the avg. age of the family is the same today. find the age of the child?

$$\begin{array}{r}
 \text{-----} \quad - \quad = \quad 17 \\
 \hline
 \text{20} \quad \text{②} \\
 \hline
 +3 \times 5 \quad \quad \quad \text{age of child} = 2 \\
 +15 \quad \quad \quad -15
 \end{array}$$

⑫ The avg weight of A, B & C is age of mother, father & son was 42 years at the time of the marriage of the son. After 1 year an infant was born and after 6 years of marriage the avg age of the family becomes 36 years. find the age of the bride at the time of the marriage.

$$\begin{array}{r}
 \text{S} \quad \text{M} \quad \text{F} \quad \text{Bride} \quad \text{Baby} \quad = \quad 36 \text{ y} \\
 \hline
 \text{48 y} \quad \quad \quad \text{③ 18 y} \\
 \hline
 +12 \times 3 \quad \quad \quad \frac{-36}{2} = -18 \\
 +36
 \end{array}$$

$\left. \begin{array}{l} \text{SMF} \rightarrow \text{Avg} \\ \text{after 6 years} \\ = 42 + 6 = 48 \end{array} \right\}$

$$\begin{array}{r}
 \text{Bride} + \text{Baby} = 36 \text{ y} \\
 \downarrow \quad \quad \quad \downarrow \\
 31 \text{ y} \quad \quad \quad 5 \text{ y} \\
 \left(\begin{array}{l} -6 \\ \hline 25 \text{ y} \end{array} \right.
 \end{array}$$

Bride + Baby for avg 18 means
Bride + Baby for age = 36

⑬ The avg. weight of A, B & C is 84 kg. if D join the avg wt. becomes 80 kg. if another person E who is 3 kg heavier than D replaces A, then the avg weight of B, C, D & E becomes 79 kg. find the weight of A.

$$\underbrace{A, B, C}_{84}, D = 80 \text{ kg} \quad \begin{matrix} D = 68 \\ E = 71 \end{matrix}$$

214

$$+4 \times 3 \\ = +12$$

$$B, C, D, E = 79$$

$$\begin{array}{r} A + B + C + D = 80 \times 4 \\ \cancel{B} + \cancel{C} + \cancel{D} + E = 79 \times 4 \\ \hline A - E = 4 \end{array} \quad \left| \begin{array}{l} A = 4 + E \\ A = 75 \end{array} \right.$$

(14) The avg temp of mon, tue, wed & thu is 31°C & the avg temp of tue, wed, thu & fri is 29.5°C . If the avg temp of mon was $37\frac{1}{2}\%$ more than the avg temp of friday. Find the temp of monday?

$$\begin{array}{r} M + T + W + Th = 31 \times 4 \\ \cancel{T} + \cancel{W} + \cancel{Th} + F = 29.5 \times 4 \\ \hline M - F = 6 \end{array}$$



$$37\frac{1}{2}\% = \frac{+3}{8}$$

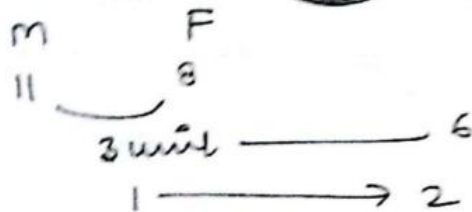

$$M = 22^\circ\text{C}$$

$$F = 16^\circ\text{C}$$

(15) The avg temp from mon to wed is 37°C while the avg temp from tue to thu is 34°C . The temp of thu. is $\frac{4}{5}$ times that of mon. Find the temp of thu?

$$M - THU = 9$$

$$TH = \frac{4}{5} M$$

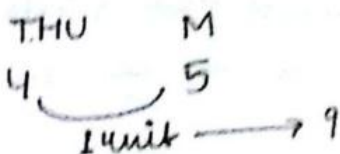

$$\frac{TH}{M} = \frac{4}{5}$$

$$THU = 4 \times 9 = 36^\circ\text{C} \quad \underline{\underline{\text{Ans}}}$$

16) There are 35 students in a hostel. If the no. of students increased by 7, the expense of mess increased by Rs 42 per day. While the avg expenditure per head decreased by Rs 1. Find the original expenditure of the mess.

35 A → mess charges.

42(A-1) → new mess charges

A Rs/day | student
(A-1) Rs/day | student

∴ 35A + 42 = 42(A-1)

7A = 84

A = 12

mess charges in starting = 35A = 35 × 12 = 420 Rs.



17) There were 42 students in a hostel, due to admission of 13 new students, expense of the mess ↑ by Rs 30 per day, while per day expenditure per student is reduced by Rs 3. What was the original expenditure of the mess per day?

42 A → mess charges

55(A-3) → new mess charges

∴ 42A + 30 = 55(A-3)

A = 15

original expense of mess = 42A = 42 × 15 = 630 Rs.

18) There are 3 natural nos. if avg of any two no. is added with the 3rd no. 24, 20 & 18 will be obtained. Find all the natural nos.?

a, b, c

$\frac{a+b}{2} + c = 24 \Rightarrow a+b+2c = 24 \times 2$

$\frac{b+c}{2} + a = 20 \Rightarrow b+c+2a = 20 \times 2$

$\frac{a+c}{2} + b = 18 \Rightarrow a+c+2b = 18 \times 2$

$\Rightarrow -4(a+b+c) = \frac{62 \times 2}{3}$

$a+b+c = 31$

(OR)

$$\begin{array}{r} 24 \\ 20 \\ 18 \\ \hline 62 \end{array}$$

$\frac{62}{2} = 31$

216

a, b, c की
separate value नहीं
पूरेगा। ये हमने
Assume की है।

$$a+b+2c = 24 \times 2$$

$$a+b+c = 24 \times 2$$

$$c = 24 \times 2 - 31 = 17$$

$$a = 20 \times 2 - 31 = 9$$

$$b = 18 \times 2 - 31 = 5$$

19) There are 4 natural no. if avg of any 3 nos is added with the 4th no. 29, 23, 21 & 17 will be obtained. find all 4 natural no's?

$$\frac{a+b+c}{3} + d = 29$$

$$a+b+c+3d = 29 \times 3$$

$$\frac{a+b+c+d}{45} + 2d = 29 \times 3$$

$$2d = 29 \times 3 - 45$$

$$d = \frac{29 \times 3 - 45}{2}$$

$$\frac{29 \times 3 - 45}{2} = 21$$

$$\frac{23 \times 3 - 45}{2} = 12$$

$$\frac{21 \times 3 - 45}{2} = 9$$

$$\frac{17 \times 3 - 45}{2} = 3$$



20) In an examination, the avg of 40 students is 72. Afterwards it is found that the marks of three students are misread as 68, 75 & 73 instead of 64, 62 & 84 resp. find the correct avg.

$$\text{X} \quad 68 + 75 + 73 = 216$$

$$\text{✓} \quad 64 + 62 + 84 = 210 \quad \left. \vphantom{210} \right\} +4$$

$$A = 72$$

$$\text{New } A = 72 + 0.1 = 72.1$$

$$\frac{+4}{40} = +0.1$$

$$\frac{72 \times 40 + 4}{40} = 72.1$$

21) The avg of 100 numbers is 46 but it was found 217 that 2 numbers 16 & 43 are mistakenly calculated as 61 & 34. find the correct avg if it was also found that total no. are only 90.

$$\begin{aligned} \text{Total} &= 100 \times 46 \\ &= 4600 \end{aligned}$$

$$\begin{array}{l} \otimes \quad 61 \quad 34 = 95 \\ \checkmark \quad 16 \quad 43 = 59 \end{array} \quad \leftarrow \begin{array}{l} \uparrow 36 \\ \downarrow \end{array}$$

$$4600 - 36 = 4564$$

$$\text{Correct avg} = \frac{4564}{90} = 50.7$$

OR

$$\begin{aligned} \text{correct avg} &= \frac{46}{100} \\ &= 0.46 \\ \frac{-36}{100} &= -0.36 \\ \hline &= 0.10 \\ &= 10\% \end{aligned}$$

$$\begin{aligned} \text{Total} &= 45.64 \times 100 = 4564 \\ \text{avg of 90 nos} &= \frac{4564}{90} = 50.7 \text{ Ans} \end{aligned}$$

22) The avg weight of some students in a class is 43 kg. When 4 new students are included the avg weight becomes 42.5 kg and the weight of these 4 students are 42, 36.5, 39 & 42.5. find the total no. of students in the class?

$$\text{Total student} = x$$

$$\text{Avg} = 43x$$

$$43x + 160 = (x+4) \times 42.5$$

\downarrow new avg \downarrow new avg

$$x = 20$$



$$\begin{array}{r} 42 \\ 36.5 \\ 39 \\ 42.5 \\ \hline 160 \end{array}$$

OR

$$\begin{array}{c} \text{---} \\ 43 \\ \text{---} \end{array} : \begin{array}{c} \text{---} \\ 40 \\ \text{---} \end{array} = 42.5$$

$$+0.5 \times x = 10$$

$$\begin{aligned} -2.5 \times 4 \\ = -10 \end{aligned}$$

$$\boxed{x = 20}$$

23) The avg of batsmen in some innings is 21.75 & the scores in next 3 innings - 28, 34 & 37 runs resp. Therefore avg ↑ by 1.125, find the no. of innings played by him?

$$\begin{array}{c} \text{---} \\ 21.75 \\ \text{---} \end{array} : \begin{array}{c} \text{---} \\ 33 \\ \text{---} \end{array} = 22.875$$

$$-1.125 \times x = -30.375$$

$$\begin{aligned} +10.125 \times 3 \\ +30.375 \end{aligned}$$

$$x = \frac{30.375}{1.125} = 27$$

$$\text{No of innings currently} = x + 3 = 30 \text{ Ans}$$

$$\begin{array}{r} 28 \\ 34 \\ 37 \\ \hline 99 \end{array}$$

Total innings = x

$$21.75x + 99 = 22.875(x+3)$$

$$\begin{array}{r} 28 \\ 34 \\ \hline 37 \\ 99 \end{array}$$

$x = 27$

24) A batsman scores 87 runs in his 17th innings, due to this his avg ↑ by 3 runs, find his current avg.

16 innings avg = x

$$16x + 87 = (x+3) \times 17$$

$x = 36$

current avg = $36 + 3 = 39$

OR

$$\begin{array}{r} 87 \\ - 51 \\ \hline 36 \end{array}$$

$3 \times 17 = 51$



25) A batsman has certain avg in his 11 innings. He scores 90 runs in 12th innings, due to this his avg ↓ by 5 runs

$$11x + 90 = (x-5) \times 12$$

$x = 150$

current = 145

$$\begin{array}{r} 90 \\ + 60 \\ \hline 150 \end{array}$$

$12 \times 5 = 60$

current = 145

26) The batting avg. of a batsmen in ~~some~~⁴⁰ (forty) innings is 50 runs, if the diff b/w his highest & lowest score is 172. if these both innings are excluded his avg becomes 48. find his highest score?

40 innings → $40 \times 50 = 2000$

38 innings → $48 \times 38 = 1824$

176

$H + L = 176$

$H - L = 172$

$H = 174$

$L = 2$

Q27

$$\begin{array}{r} 48 \\ - 2 \times 38 \\ \hline = -76 \end{array} \quad \begin{array}{r} 88 \\ + 76 \\ \hline = 138 \end{array} = 50$$

219

Run in these two innings = $88 \times 2 = 176$

Q27 A batsman has an avg of 30 runs in his 42 Innings. The diff b/w his max. & min score is 100. if these two innings are removed his avg for 40 Innings comes down to 28. what is his maximum score?

$$\begin{array}{l} 42 \text{ Innings} \longrightarrow 30 \times 42 = 1260 \\ 40 \text{ Innings} \longrightarrow 28 \times 40 = 1120 \end{array} \quad \begin{array}{r} H + L = 140 \\ H - L = 100 \\ \hline H = 120 \\ L = 20 \end{array}$$

Q28 If the bowling avg of bowler is 12.4 runs per wicket. He takes 10 wickets in his next innings by giving 52 runs, due to this his bowling avg improved by 0.4 run per wicket. find the total no. of wickets taken by him at present?

- wickets = x
 $A = 12.4 \text{ Runs/wickets}$
 $\text{Runs} = 12.4x$



Bowling Avg = $\frac{\text{Total Run}}{\text{Total wicket}}$

wickets at present = $170 + 10 = 180$.

$$\frac{12.4x + 52}{x + 10} = 12$$

$$x = 170$$

By.
 Pardeep Chhokker
 7206446517

OR

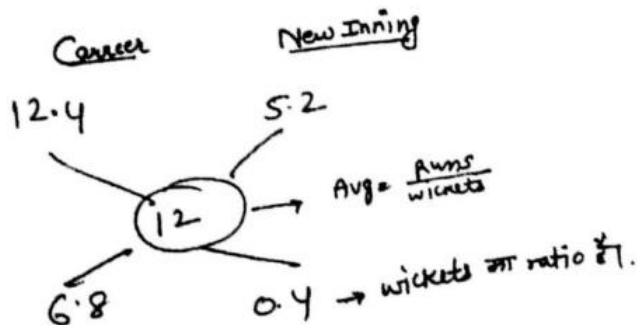

$$\begin{array}{r} 17 \\ \times 10 \\ \hline 170 \end{array} \quad \begin{array}{r} 1 \\ \times 10 \\ \hline 10 \end{array}$$

wickets at present = $170 + 10 = 180$ Ans

Q29) In a class the avg of boys & girls is 'A'. The ratio of no. of boys and no. of girl is 3:1. and the avg of the boys is $A+1$. find the avg of girls.

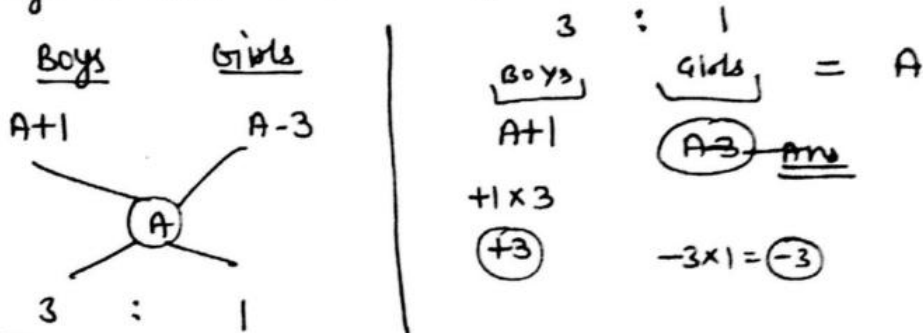

Q30) The avg ~~rate~~ weight of 8 persons is increased by 2.5 kg when one of them who weighs 56 kg is replaced by a new man. find the weight of new man.

↓		$2.5 \times 8 = 20$
56 kg		
+ 20		

76 kg		

⊕

Successive increase / successive
↓
(CI)

decrease

↓
successive discount

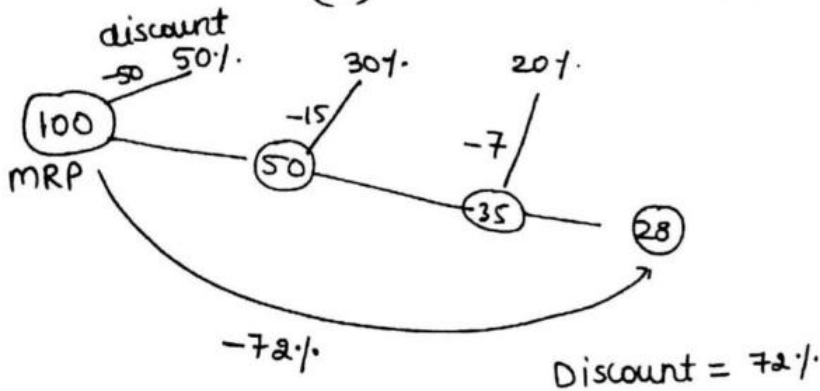

⊕

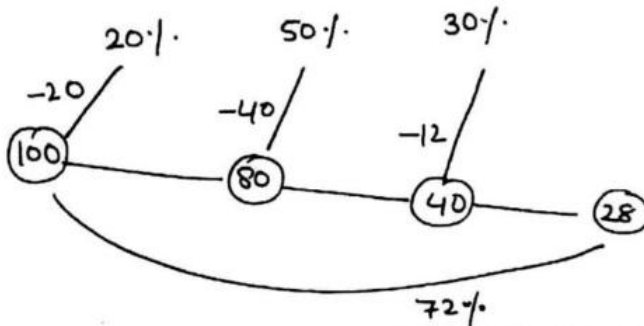

⊕

Two discounts = $x\%$, $y\%$
 successive discount = $x + y - \frac{xy}{100}$

⊕

20%, 50%, 30%

$$\Rightarrow 20 + 50 - \frac{20 \times 50}{100} = 60\%, \quad 30\%$$

$$\Rightarrow 60 + 30 - \frac{60 \times 30}{100} \Rightarrow 72\%$$

⊗

10%, 20%, find equivalent discount

$\frac{1}{10}$ $\frac{1}{5}$

$$\frac{10}{5} \quad \frac{9}{4}$$

$$\frac{50}{36}$$

-14

$\frac{14}{50} \times 100 = 28\%$ Ans

4 successive discounts are $12\frac{1}{2}\%$, $9\frac{1}{11}\%$, $11\frac{1}{9}\%$, 10% . 222

Equivalent discount = $(\frac{1}{8}) (\frac{1}{11}) (\frac{1}{9}) (\frac{1}{10})$

$$\begin{array}{r} 8 \quad 7 \\ 11 \quad 10 \\ \hline 9 \quad 8 \\ \hline 10 \quad 9 \\ \hline 11 \quad 7 \\ \hline \quad 4 \end{array}$$

$$\frac{4}{11} \times 100 = 36\frac{4}{11}\%$$

57 $\frac{1}{7}\%$, 66 $\frac{2}{3}\%$. find equivalent discount.

$(\frac{4}{7}) (\frac{2}{3})$

$$\begin{array}{r} 7 \quad 3 \\ \hline 3 \quad 1 \\ \hline 7 \quad 1 \\ \hline \quad 6 \end{array}$$

$$\frac{6}{7} \times 100 = 85\frac{5}{7}\%$$

① Two successive increase are $12\frac{1}{2}\%$, $12\frac{1}{2}\%$, find equivalent increase.

$(\frac{1}{8}) (\frac{1}{8})$

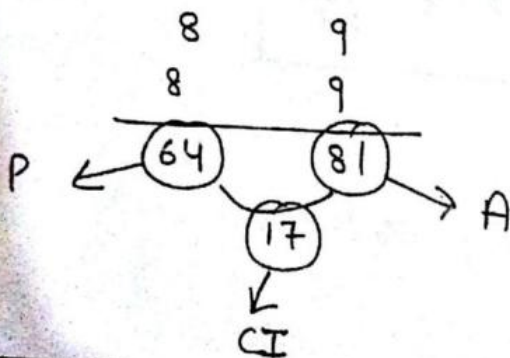

$$\frac{17}{64} \times 100.$$



② P = ?

Time = 2yr

r = $12\frac{1}{2}\%$

CI = 6.80 Rs

223

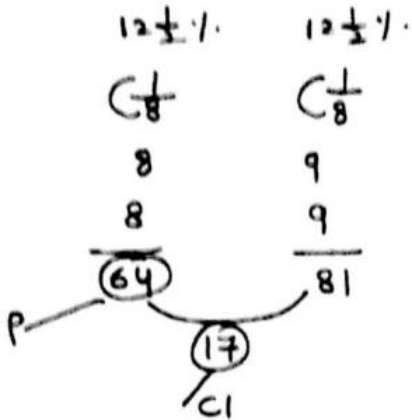

17 unit — 6.80
 1 — $\frac{6.80}{17} = 0.4$
 $P = 64 \times 0.4 = 25.6 \text{ Rs.}$

- ③ $P = ?$
 $r = 16\frac{2}{3}\%$
 $T = 2 \text{ yr}$
 $CI = ?$
 Amount = 1470 Rs.

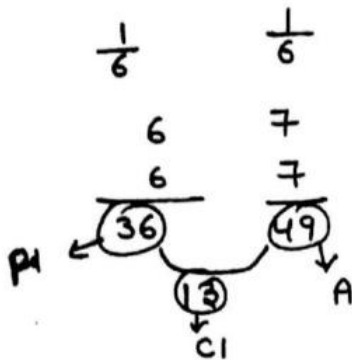

49 unit → 1470
 1 → 30
 Principal = $30 \times 36 = 1080 \text{ Rs}$
 $CI = 13 \times 30 = 390 \text{ Rs.}$

OR $r = \frac{1}{6}$, Time = 2 year,

let $P = 6^2 = 36$

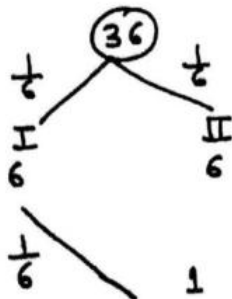

$SI = 12 \text{ unit.}$
 $CI = 13 \text{ unit.}$ } diff 1 unit

$P + CI = 36 + 13 = 49$

49 — 1470
 1 — 30.

Principal = $36 \times 30 = 1080 \text{ Rs}$

$CI = 13 \times 30 = 390 \text{ Rs}$

diff b/w CI & SI = 30 Rs.

④ $A = ?$, $P = ?$, $r = 11\frac{1}{9}\%$, $T = 2 \text{ years}$.

CI of 2nd year = 70 Rs.

$11\frac{1}{9}\% = \frac{1}{9}$

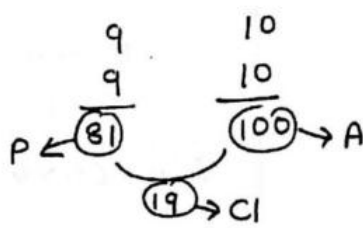

अगर P, A, CI के अलावा कुछ और पूछा है तो ये method फेल.

OR

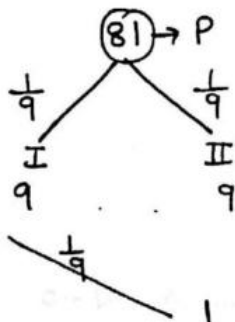

SI = 18

CI = 19

CI - SI = 1

2nd year CI = 10

10 unit — 70

1 — 7

$P = 81 \times 7 = 567 \text{ Rs}$

$A = 100 \times 7 = 700 \text{ Rs}$



⑤ $P = ?$, $r = 15\%$, $T = 2 \text{ years}$, $CI - SI = 2.70 \text{ Rs}$, $CI = ?$

$r = 15\% = \frac{3}{20}$

let $P = (20)^2 =$

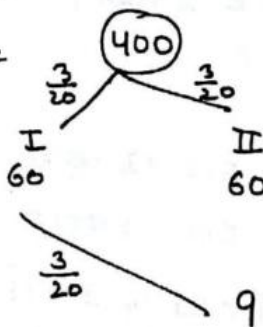

CI = 129

SI = 120

CI - SI = 9

9 unit — 2.70 Rs

1 — $\frac{2.70}{9} = 0.30$

$P = 400 \times 0.30 = 120 \text{ Rs}$

CI = 129×0.3

= 38.70 Rs

⑥ $P = ?$, $t = 2 \text{ year}$, $CI - SI = 40 \text{ Rs}$

R for 1st year $= 14\frac{2}{7}\%$, for 2nd year $= 11\frac{1}{9}\%$.

$r = \frac{1}{7}$, $\frac{1}{9}$

Let $P = 7 \times 9 = 63$.

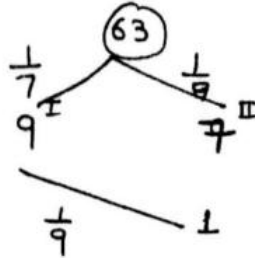

$SI = 16$
 $CI = 17$
 $CI - SI = 1$

1 unit $\rightarrow 40$

$P = 63 \times 40 = 2520 \text{ Rs.}$ Anu.

⑦ $P = 18000 \text{ Rs}$, $R = 16\frac{2}{3}\%$, $T = 1 \text{ year } 73 \text{ days}$, $CI = ?$

$R = 16\frac{2}{3}\% = \frac{1}{6}$

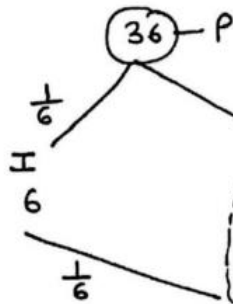

This is for 365 days

CI for 1 year $= 6$

$\frac{7}{365} \times 73 = 1.4$

CI for 1 year 73 days $=$

$6 + 1.4 = 7.4$

36 ——— 18000
 1 unit ——— $\frac{18000}{36} = 500$

$\therefore CI = 7.4 \times 500$
 $= 3700 \text{ Rs.}$

⑧ $P = ?$, $r = 15\%$, $T = 1 \text{ year } 6 \text{ month}$, $CI = 9.45 \text{ Rs.}$

$r = 15\% = \frac{3}{20}$

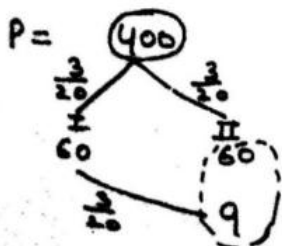

CI for 1 year $= 60$

CI of 6 months $=$

$\frac{69}{2} = 34.5$

CI for 1 year 6 month $=$

$60 + 34.5 = 94.5$

94.5 unit ——— 9.45

1 unit ——— $\frac{9.45}{94.5} = \frac{1}{10}$

Principal $= 400 \times \frac{1}{10}$

$= 40 \text{ Rs}$ Anu.

9) $P = ?$, $T = 3 \text{ yr}$, $R = 10\%$, $CI = 6620 \text{ Rs.}$

226

$R = \frac{10}{100}$

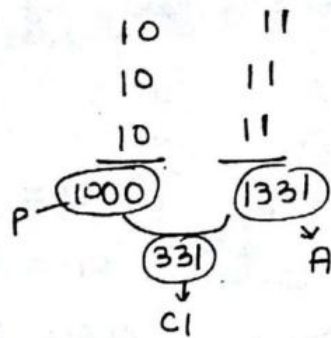

$331 \text{ --- } 6620$
 $1 \text{ --- } 20$
 $P = 1000 \times 20 = 20,000 \text{ Rs.}$

OR $r = \frac{1}{10}$, $t = 3 \text{ yr}$

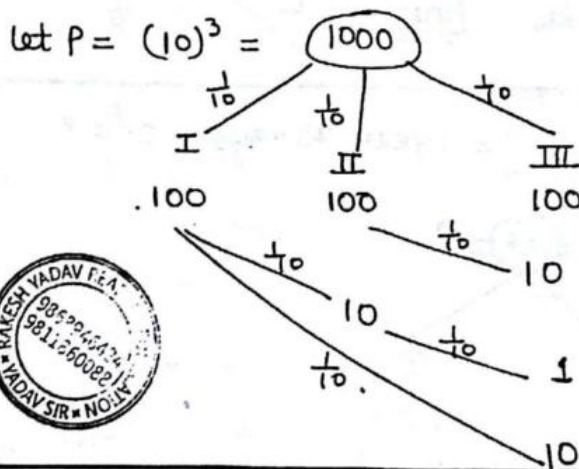

$SI = 300$
 $CI = 331$



10) $P = ?$, $T = 3 \text{ yr}$, $R = 15\%$, $CI - SI = 1701 \text{ Rs.}$

$R = 15\% = \frac{3}{20}$

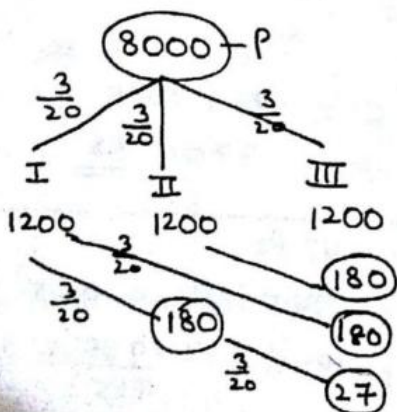

$SI = 3600$
 $CI = 4167$
 $CI - SI = 567$
 $567 \text{ unit --- } 1701 \text{ Rs}$
 $1 \text{ unit --- } \frac{1701}{567} = 3$

Principal = $8000 \times 3 = 24000 \text{ Rs}$ Ans

11) $P = ?$ $R = 12\frac{1}{2}\%$

$T = 3 \text{ yr}$ $CI - SI = 12.50 \text{ Rs.}$

$$r = 12\frac{1}{2}\% = \frac{1}{8}$$

(9.27)

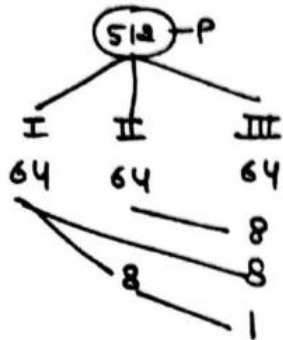

$$CI - SI = 25$$

$$25 \text{ unit} \rightarrow 12.50$$

$$1 \text{ unit} \rightarrow \frac{1}{2}$$

$$P = 512 \times \frac{1}{2} = 256 \text{ Rs. } \underline{\text{Ans.}}$$



$$r = \frac{1}{8} \rightarrow \text{3rd yr 1\% of 1st yr}$$

$$CI - SI = 3 \times 8 + 1 = 25$$

(12) $P = ?$ $r = 16\frac{2}{3}\%$

$T = 3 \text{ yr}$ $CI - SI = 5.70 \text{ Rs.}$

$$r = \frac{1}{6}, \text{ let } P = 6^3 = 216$$

$$CI - SI = 3 \times 6 + 1 = 19$$

$$19 \text{ unit} \rightarrow 5.70$$

$$1 \text{ unit} \rightarrow 0.3$$

$$\therefore P = 216 \times 0.3$$

$$= 648 \text{ Rs. } \underline{\text{Ans.}}$$

(13) $P = ?$, $T = 3 \text{ yr}$, $r = 16\frac{2}{3}\%$

3rd yr CI - 2nd year CI = 420 Rs.

$$R = \frac{1}{6}$$

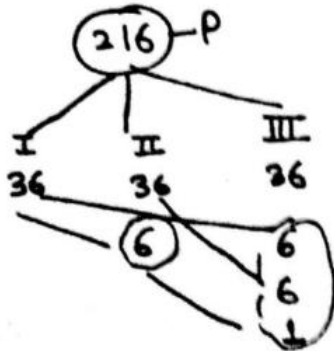

$$13 - 6 = 7 \rightarrow 420$$

$$1 \text{ unit} \rightarrow 60$$

$$P = 216 \times 60 = 12960 \text{ Rs.}$$

$P = 1000$, $r = 10\%$, $n = 10$
 $FV = P(1 + \frac{r}{n})^{nt}$
 $FV = 1000(1 + \frac{0.10}{1})^{10}$
 $FV = 1000(1.10)^{10}$
 $FV = 1000 \times 2.5937$
 $FV = 2593.74$



$1 = 1000$
 $2 = 1100$
 $3 = 1210$
 $4 = 1331$
 $5 = 1464.10$
 $6 = 1610.51$
 $7 = 1771.56$
 $8 = 1949.92$
 $9 = 2144.91$
 $10 = 2367.36$

Q2) $P = 2000$, $r = 10\%$, $n = 2$, $t = 10$



$\frac{20}{2} = 10$
 $CI = 2000(1 + \frac{0.10}{2})^{20}$
 $CI = 2000(1.05)^{20}$
 $CI = 2000 \times 2.6533$
 $CI = 5306.60$

$\rightarrow 2000 \times 2.6533 = 5306.60$

$CI = 5306.60$

Q3) $P = 1000$, $r = 10\%$, $n = 2$, $t = 10$

Calculate CI when rate is compounded half years.

$T = (1\text{yr } 6\text{month}) \times 2 = 3 \text{ half yearly}$

(229)

$R = \frac{20\%}{2} = 10\% = \frac{1}{10}$

10	11
10	11
10	11
1000	1331
331	

1000 unit \rightarrow 20,000
 1 unit \rightarrow 20

CI = 331 \Rightarrow 331 \times 20
 \Rightarrow 6620 Rs Ans

(17) $P = 8000$ Rs

$r = 20\%$

$T = 1\text{yr}$

find CI-SI if rate is compounded quarterly.

$T = 1 \times 4 = 4$ Quarter years.

$r = \frac{20\%}{4} = 5\%$ per quarter year.

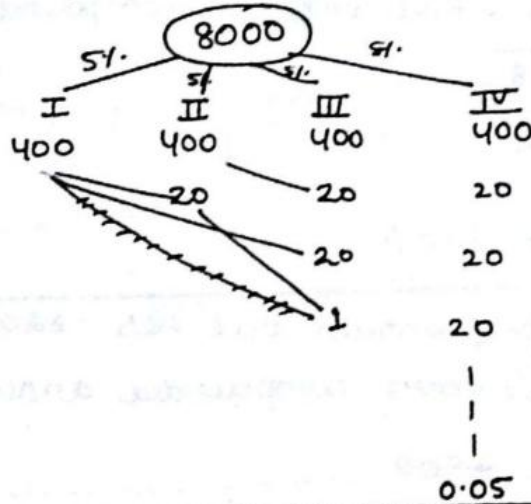

CI-SI = 124.05 Rs.

(18) if a certain sum of money of Rs 225 amounts to Rs 256 in two years. find the rate of compound interest ?

$$\sqrt{225} \quad \sqrt{256}$$

$$15 \quad 16$$

└───┬───┘
1

1 साल के लिए square करेंगे.

280

$$\frac{1}{15} \times 100 = 6\frac{2}{3}\% \text{ Ans}$$

(19) if a certain sum of money of Rs 102400 amounts to Rs 145800 in 3 years. find the rate of compound interest.

$$\frac{102400}{\sqrt[3]{512}} \quad \frac{145800}{\sqrt[3]{729}}$$

$$8 \quad 9$$

└───┬───┘
1

* 3 साल में 512 से 729 हुआ है। 1 साल के लिए cube करेंगे।

$$\frac{1}{8} \times 100 = 12\frac{1}{2}\%$$

(20) if a certain sum of money becomes 8 times of itself in 3 years. find rate of compound interest.

$$\sqrt[3]{1} \quad \sqrt[3]{8}$$

$$1 \quad 2$$

└───┬───┘
1

$$\frac{1}{1} \times 100 = 100\%$$

(21) A what rate % per annum will Rs. 2304 amounts to Rs 2500 in two years compounded annually.

$$\frac{2304}{1152} : \frac{2500}{1250}$$

$$\sqrt[2]{576} : \sqrt[2]{625}$$

$$24 \quad 25$$

└───┬───┘
1

$$\frac{1}{24} \times 100 = 4\frac{1}{6}\%$$

22) At what rate per annum will rupees 32000 yield (231) a compound interest of 5044 Rs in 9 months interest being compounded quarterly.

$$\begin{array}{ccc} 32000 & : & 37044 \\ \sqrt[3]{8000} & & \sqrt[3]{9261} \\ 20 & & 21 \end{array}$$

$$\begin{array}{l} 9 \text{ month} \\ \times 4 \text{ quarterly} \\ \hline 36 \text{ months} \\ = 3 \text{ quarterly years.} \end{array}$$

$$\frac{1}{20} \times 100 = 5\% \text{ per quarterly}$$

$$5\% \times 4 = 20\% \text{ per annum.}$$

CLASS
31

23) if a certain sum of money becomes equal to ^{8 times of} itself in 8 years. In how much time it will be 243 times of itself

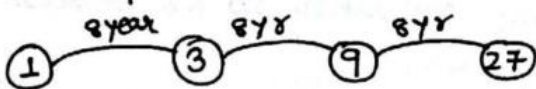

$$1 \rightarrow 8 \text{ year}$$

$$243 = 3^5 \rightarrow 8 \times 5 = 40 \text{ year.}$$

$$\begin{array}{ccc} 1 & : & 3 \\ & & \sqrt[8]{3} \\ \hline & & \sqrt[8]{3} - 1 \end{array}$$

$$R = \frac{\sqrt[8]{3} - 1}{1} \times 100 \%$$

24) if a certain sum of become double of itself in 3 years. In how much time it will be 64 times of itself

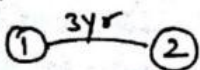

$$2^1 \rightarrow 3 \text{ year}$$

$$64 \rightarrow 2^6 \rightarrow 6 \times 3 = 18 \text{ yr}$$

Rate:

$$\begin{array}{ccc} 1 & & 2 \\ & & \sqrt[3]{2} \\ \hline & & \sqrt[3]{2} - 1 \end{array}$$

$$r = \sqrt[3]{2} - 1 \times 100\%$$

25) if a certain sum of money amounts to Rs 4500 in 5 years and Rs 6750 in 10 years. find principal. 232



$$\frac{6750}{4500} = \frac{3}{2} \quad (4500 \text{ का } \frac{3}{2} \text{ times})$$

$$P \times \frac{3}{2} = \overset{1500}{4500} = 3000 \text{ Ans.}$$

26) if a certain sum of money amounts to Rs 650 in two years and Rs 676 in 4 years. find principal.



$$\frac{676}{650} = \frac{26}{25} \text{ times of } 650.$$

$$P \times \frac{26}{25} = \overset{25}{650}$$

$$P = 625 \text{ Rs Ans.}$$



27) if a certain sum of money amounts to Rs 66300 in 10 yrs and Rs 99450 in 20 yrs.

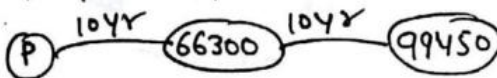

$$\frac{99450}{66300} = \frac{3315}{2210}$$

$$P \times \frac{3315}{2210} = \overset{20}{66300}$$

$$P = 44200 \text{ Rs Ans.}$$

28) if a certain sum of money becomes Rs 8000 in 2 years and Rs 27000 in 5 years. find the principal.

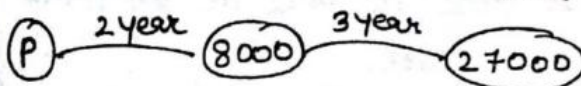

$$\sqrt[2]{8000} \quad \sqrt[3]{27000}$$

2 3

└──────────┘

1.

$$\frac{1}{2} \times 100$$

$$R = 50\%$$

बिना rate निकाले
solve नहीं होगा.

$P = ?$

$r = 50\% = \frac{1}{2}$

$t = 2 \text{ yr}$

$A = 8000$

2	3	9 unit — 8000	(233)
2	3	1 unit — $\frac{8000}{9}$	
9	9	$P = 4 \text{ unit} — \frac{8000}{9} \times 4$	
P	A	$= \frac{32000}{9} = 3555.55 \text{ Rs.}$	

29) The simple interest and compound interest on a certain sum of money is 400 & 410 Rs respectively. find principal and rate of interest? (time = 2 years)

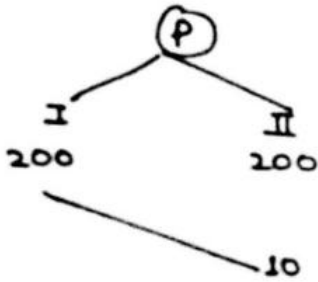

$\frac{10}{200} \times 100 = 5\%$

$P \times \frac{5}{100} = 200$

$P = 4000$



30) If the diff b/w CI and SI on a certain sum of money of Rs 5000 for 2 years is Rs 72. find rate of interest?

$R = \sqrt{\frac{72 \times 36}{5000 \times 2}} \times 100$
 $= \frac{6}{50} \times 100 = 12\%$

Time = 2 year
 CI - SI = D
 Principal = P
 $R = \sqrt{\frac{D}{P}} \times 100$

31) At what rate percent the diff of CI and SI on a certain sum of money of Rs 30720 in 3 years is 1500.

$r\% = \frac{1}{x} \times 100$

$\frac{3x+1}{x^3} = \frac{D}{P} = \frac{1500}{30720} = \frac{25}{512}$

$x^3 = 512, \therefore x = 8$

$r\% = \frac{1}{8} \times 100 = 12\frac{1}{2}\%$ (2nd method next page for explained)

Time = 3 year
 CI - SI = D
 Principal = P
 $\frac{D}{P} = \left(\frac{r}{100}\right)^2 \left(\frac{300+r}{100}\right)$

Time = 3 year
 $r\% = \frac{1}{x} \times 100$
 $\frac{3x+1}{x^3} = \frac{D}{P}$

calculate value of x from this relation and put in $r\% = \frac{1}{x} \times 100$ to find rate.

(32) Ratio of 3 year of CI and SI of one year on a certain sum of money is 3.64 : 1 . find rate percent.

3.64 : 1
 (364) : (100)
 3Yr CI : 1Yr SI

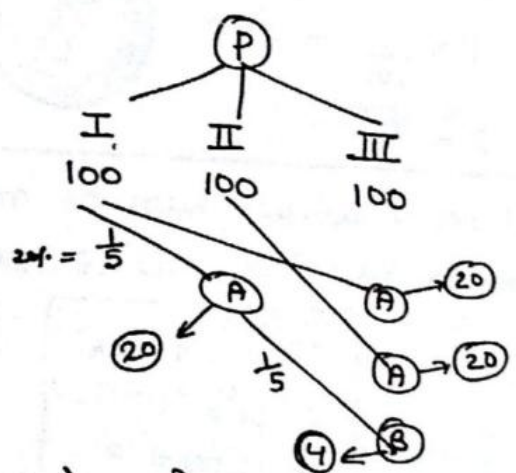

diff b/w CI-SI = 64.
 $3A + B = 64$

(Put from options)
 or Try value putting.
 $A = 20$
 $60 + 4 = 64$
 $3A + B = 64$ (satisfy)
 $r = 20\%$
 $A = r$
 $B = \frac{r^2}{100}$

20%. A को 100 पैसे calculate किया है, Hence. A is rate of interest.

(33) The ratio of diff b/w CI and SI for 3 years to the diff of CI and SI for 2 years is 19 : 6 . find rate of interest.

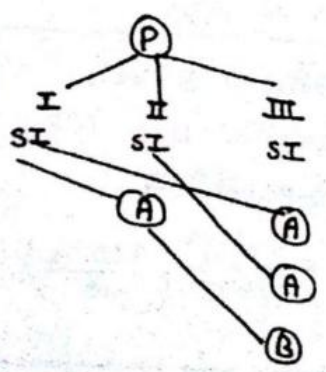

$3A + B$: A
 diff of CI & SI of 3 years : diff of CI & SI for 2 years.
 $3A + B$: A
 19 : 6
 $\frac{1}{6} \times 100 = 16 \frac{2}{3} \%$ Ans

- (34) A man want to invest 16850 in bank account of his (235) two sons whose ages are 12 years and 16 years in such a way so that they will get equal amount at an age of 120 years at the rate of $33\frac{1}{3}\%$ per annum. find the share of Younger son.

$$\begin{array}{l}
 \begin{array}{c}
 16850 \\
 \swarrow \quad \searrow \\
 T=108 \text{ yr} \quad T=104 \text{ yr} \\
 \text{Younger} \quad \text{Elder} \\
 C \left(1 + \frac{1}{3}\right)^{108} = B \left(1 + \frac{1}{3}\right)^{104} \\
 \Rightarrow C \left(\frac{4}{3}\right)^{108} = B \left(\frac{4}{3}\right)^{104} \\
 \Rightarrow \frac{\left(\frac{4}{3}\right)^{108}}{\left(\frac{4}{3}\right)^{104}} = \frac{B}{C} \\
 \therefore \frac{B}{C} = \left(\frac{4}{3}\right)^4 = \frac{256}{81}
 \end{array}
 \end{array}$$

$$256 + 81 = 337$$

$$\begin{array}{r}
 337 \text{ --- } 16850 \\
 1 \text{ unit --- } 50
 \end{array}$$

(OR)

Age diff	Younger	Elder
1 year -	3	4
2 year -	9	16
3 year -	$(3)^3$	$(4)^3$
4 year -	$(3)^4$	$(4)^4$

$$\begin{aligned}
 r &= 33\frac{1}{3}\% \\
 &= \frac{1}{3} \text{ --- Younger} \\
 \text{Elder} &= 3+1 = 4
 \end{aligned}$$

$$A = P \left(1 + \frac{r}{100}\right)^T$$

C → Part of Younger
B → Part of Elder

$$\begin{aligned}
 \text{Younger son} = C &= 81 \times 50 \\
 &= 4050
 \end{aligned}$$

$$\begin{aligned}
 \text{Elder} = B &= 256 \times 50 \\
 &= 12800
 \end{aligned}$$



236

35) A man purchase a motorbike for a certain price and promise to pay the ~~installment~~ ^{price} in 3 equal annual installments of 10,800 at the rate of 20% per annum. find the cost price of motor bike.

	price	installment	
1 st yr	5 × 36 = 180	6 × 36	20% = $\frac{+1}{5}$ But all installments are equal. so equal them.
2 nd yr	25 × 6 = 150	36 × 6	
3 rd yr.	125 = 125	216	
	<u>455</u>	<u>216</u>	
		216 unit ——— 10,800	
		1 unit ——— $\frac{10,800}{216} = 50$	

455 unit → 50 × 455 = 22750 Rs Ans.

36) A man borrowed a sum of Rs 25220 from a bank. and promise to pay the amount in 3 annual equal installment at the rate of 5% per annum. find the value of each installment.



price	Installment	
20 × 441 (8820)	21 × (441)	5% = $\frac{1}{20}$ To equal installments
400 × 21 (8400)	441 × (21)	
8000 — (8000)	9261	
<u>25220</u>		
25220 unit ——— 25220	installment = 9261 unit	
1 unit ——— 1 Rs	9261 unit = 9261 × 1	
	= 9261 Rs <u>Ans.</u>	

37) A man borrowed a sum of Rs 3000 from bank (237) at 5% per annum. He pays back Rs 1000 at the end of each year. Calculate how much amount he will pay at the end of 3rd year to clear all his dues.

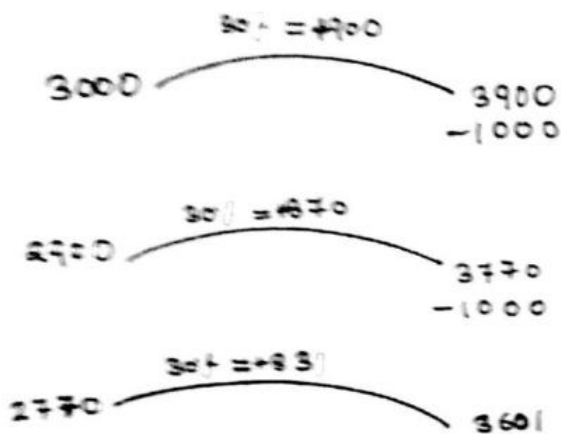

He has to pay 320.375 Rs at the end of 3rd year to clear the loan.

38) $P = 4000$

$R = 8\%$

$T = 3 \text{ years}$

$CI - SI = ?$

$CI - SI = \left(\frac{RT}{100}\right)^2 = 0.64\%$

$\Rightarrow 4000 \times 0.64\% = 25.6 \text{ Rs.}$

$$SI = RT, \quad CI = \left(1 + \frac{RT}{100}\right)^T$$

$$CI - SI = \left(\frac{RT}{100}\right)^2$$

39) $P = 4000$

$R = 8\%$

$T = 1 \text{ yr } 3 \text{ months}$

$CI - SI = ?$

$CI - SI = \frac{RT^2}{100} = 0.96\%$

$4000 \times \frac{8}{100} = 320 \text{ Rs.}$

rate for 3 months = $\frac{8}{4} \times 3 = 6\%$

40) $P = ?$

$T = 1\text{yr } 6\text{ month}$

$r = 6\%$

$CI = 4590\text{ Rs}$

$$CI = \left(x + y + \frac{xy}{100}\right)$$

$$= 6 + 3 + \frac{6 \times 3}{100} = 9.18$$

r for 6 months
 $= \frac{6}{12} \times 6 = 3\%$

$P \times 9.18\% = 4590$

$P \times \frac{918}{100 \times 100} = 4590$

$P = 50,000$

Ans

41) $P = ?$, $r = 5\%$, $T = 1\text{yr } 73\text{ days}$, $CI = 302.50\text{ Rs}$

$CI = \left(x + y + \frac{xy}{100}\right)\%$

$\left(5 + 1 + \frac{5 \times 1}{100}\right)\%$
 $= 6.05\%$

rate for 73 days
 $= \frac{5}{365} \times 73 = 1\%$



$P \times 6.05\% = 302.50$

$P \times \frac{605}{100 \times 100} = \frac{30250}{100}$

$P = 5000\text{ Rs}$

Ans

42) $P = 8000$,

$T = 3\text{yr}$

$R = I \rightarrow 1\%$
 $II \rightarrow 2\%$
 $III \rightarrow 3\%$

$CI - SI = ?$

$1\%, 2\%, 3\%$
 $1 + 2 + \frac{1 \times 2}{100}$
 $3.02\%, 3\%$

$3.02 + 3 + \frac{3.02 \times 3}{100}$
 $6.02 + 0.0906$
 $= 6.1106\%$

$$8000 \times \frac{0.1106}{100}$$

8.848 Rs.

$$SI = 1\% + 2\% + 3\% \quad (239)$$

$$= 6\%$$

$$CI - SI = \frac{6.1106}{-6}$$

$$0.1106\%$$

(43) P = ? , T = 3y , R = I → 5% , CI = 12476 Rs.
 II → 4%
 III → 3%

5% 4% 3%

9.02 , 3%

$$9.02 + 3 + \frac{9.02 \times 3}{100}$$

$$12.02 + 0.276 = 12.476\%$$

$$P \times \frac{12.476}{100} = 12476$$

$$P \times \frac{12476}{100 \times 100} = 12476$$

P = 10,0000 Ans

CLASS
32



(#) Time 3 years.

Rate	CI	CI-SI
a%	$3a \cdot \frac{3a^2}{100} - \frac{a^3}{100}$	$0. \frac{3a^2}{100} - \frac{a^3}{100}$
4%	12.4864%	0.4864%
1%	3.0301%	0.301%
2%	6.1208%	
5%	15.7625%	
10%	33.1000%	
	(33.1%)	

(44) $P = ?$
 $r = 4\%$

Time = 1 yr 6 month

240

$CI - SI = 204 \text{ Rs}$ & CI is calculated half yearly.
 $\downarrow \quad \downarrow$
 Half yearly Annually

if calculated annually = $4 + 2 + \frac{4 \times 2}{100}$
 $= 6.08\%$

(rate for 6 months = $2 \times \frac{4}{12} \times 6 = 2\%$)

if calculated half yearly $\Rightarrow T = 3 \text{ years}, r = \frac{4}{2} = 2\%$
 rate of 3 years = 6.1208%

$\Rightarrow \begin{array}{r} 6.1208\% \\ - 6.08 \\ \hline 0.0408\% \end{array}$

$P \times \frac{408}{10000 \times 100} = 204$

$P \times 0.0408\% = 204$

$P = 500000 \text{ Rs}$ Ans

(45) $P = 4000$
 $r = 6\%$

Time = 1 year 6 month

$CI - CI = ?$
 $\downarrow \quad \downarrow$
 Half yearly Annual

if calculated annually, $CI = 6 + 3 + \frac{6 \times 3}{100} = 9.18\%$

if calculated half yearly, $\rightarrow T = 3 \text{ years}, \text{ rate} = 3\%$
 $CI = 9.2727\%$

$\begin{array}{r} 9.2727 \\ - 9.18 \\ \hline 0.0927\% \text{ of } P \end{array}$

$4000 \times \frac{0.0927}{100} = 3.708 \text{ Rs}$ Ans

SIMPLE INTEREST

① If the SI on a certain sum of money for 3 years at the rate of 12.5% is Rs 3500 less than its principal. find the sum and SI.

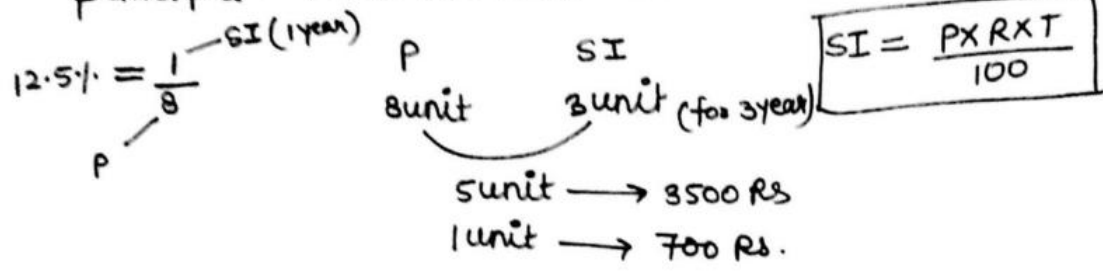

Principal = $8 \times 700 = 5600$ Rs
 SI = $3 \times 700 = 2100$ Rs. Ans:

② If the SI on a certain sum of money @ $6\frac{2}{3}\%$ per annum for 4 years is Rs 4400 less than its principal. find the SI and principal.

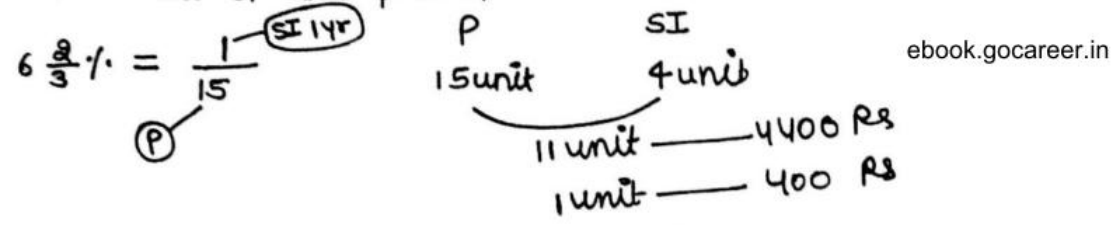

Principal = $15 \times 400 = 6000$ Rs.
 SI = $4 \times 400 = 1600$ Rs.

③ The rate of SI for 1st 3 years is 6%, for next 4 years it is 7%. And the period beyond 7 years it is 7.5% per annum. If a man invest Rs 18800 for 11 years, find the SI earned by him?

$6\% \times 3\text{yr} = 18\%$ $7\% \times 4\text{yr} = 28\%$ $7.5\% \times 4\text{yr} = 30\%$ <hr style="width: 100%;"/> Rate for 11 yr = 76%	$SI = 18800 \times \frac{76}{100}$ $= 14288$ Rs <u>Ans</u>
---	---

④ The rate of SI on a certain sum of money 242 is 4% per annum for 1st two years, 6% per annum for next 4 years, and 8% per annum for the period beyond 6 years. If the simple interest earned by a sum is Rs 1120 in 9 years, find the sum.

$$4\% \times 2\text{yr} = 8\%$$

$$6\% \times 4\text{yr} = 24\%$$

$$8\% \times 3\text{yr} = 24\%$$

$$\text{Rate for 9 years} = \underline{56\%}$$

$$P \times \frac{56}{100} = \frac{1120}{20}$$

$$P = 20,00 \text{ Rs.} \quad \underline{\text{Ans}}$$

⑤ A bicycle can be purchased on cash payment of Rs 1500. But the same cycle can also be purchased on the cash down payment of Rs. 350 and rest can be paid in three equal annual installment of Rs 400 for next three years. Find the rate of simple interest?

$$\begin{array}{r} 1500 \\ - 350 \\ \hline 1150 \\ 1150 \\ 750 \\ 350 \\ \hline 2250 \end{array}$$

$$400 \times 3 = 1200$$

$$\text{SI} = \frac{1200}{1150} \times 50 \text{ Rs}$$

$$\begin{array}{l} -400 \text{) I} \\ -400 \text{) II} \\ -400 \text{) III} \end{array}$$

$$\frac{1150 \times r \times 1}{100 \times 12} + \frac{750 \times r \times 1}{100 \times 12} + \frac{350 \times r \times 1}{100 \times 12} = 50$$

$$\frac{r}{1200} [1150 + 750 + 350] = 50$$

$$\frac{r}{1200} \times 2250 = 50$$

$$\boxed{r = 26 \frac{2}{3} \%} \quad \underline{\text{Ans}}$$

⑥ The cash price of a pen is 60 Rs. But it can also be purchased on a cash down payment of Rs 20 and 6 monthly equal installment @ the rate of Rs 8 per month. Find the rate percent.

$$\begin{array}{r} 60 \\ 20 \\ \hline 40 \end{array} \quad 9P \times 6 = 48$$

$$\begin{array}{r} 40 \\ 32 \\ 24 \\ 16 \\ 8 \\ 0 \\ \hline \end{array} \quad \begin{array}{l} -8 \\ -8 \\ -8 \\ -8 \\ -8 \end{array}$$

$$\begin{array}{r} 120 \\ \hline \end{array}$$

Principal of 6 installments.

$$\frac{120 \times r \times 1}{100 \times 12} = 8$$

$$r = 80\%$$

Calculate the Principal of every month.

(243)

- ⑦ The cash price of a pen is Rs 10. But it can also be purchased on 11 monthly equal installment of Rs 1 each. Find the rate of simple interest?

10
9
8
7
6
5
4
3
2
1
0

$$\frac{11 \times 55 \times r \times 1}{100 \times 12} = 1$$

$$r = 21 \frac{9}{11}\%$$

- ⑧ A man borrowed a sum of Rs 7000 from bank at SI. After 3 years he paid Rs 3000 to the bank and @ the end of 5 years he paid Rs 5450 and clear all his dues. Find the rate percent?

$$\begin{array}{r} 7000 \\ 7000 \\ 7000 \\ 4000 \\ 4000 \\ \hline 29000 \end{array}$$

$$\begin{array}{r} 3000 \\ + 5450 \\ \hline 8450 \\ - 7000 \\ \hline 1450 = SI \end{array}$$

$$\frac{29000 \times r \times 1}{100} = 1450$$

$$r = 5\%$$

- ⑨ A man borrowed a sum of Rs 6000 from bank at SI. After 4 years he paid Rs 2500. and at the end of 5th year he paid Rs 4550 and clear all his dues. find the rate of simple interest?

$$\begin{array}{r} 6000 \\ 6000 \\ 6000 \\ 6000 \\ 6000 \\ \hline 3500 \\ \hline 27500 \end{array}$$

$$\begin{array}{r} 2500 \\ 4550 \\ \hline 7050 \\ -6000 \\ \hline \text{SI} = 1050 \end{array}$$

$$\frac{27500 \times r \times 1}{100} = 1050$$

$$r = 3\frac{9}{11}\%$$

- ⑩ A man lent out two equal sums in two parts at the rate 8% and 7% per annum on SI. If the former is recovered 6 months earlier than the later, & he received equal amount of Rs 2560 each from both the parts. find the principal.

I	II
P	P
8%	7%
$(t - \frac{1}{2})$ year	t year

कोनों से equal amt. receive हो रही है। So, SI same होगा

$$\frac{P \times 8 \times (t - \frac{1}{2})}{100} = \frac{P \times 7 \times t}{100}$$

$$8t - 4 = 7t$$

$$\boxed{t = 4}$$

$$\Rightarrow P + \frac{P \times 8 \times 4}{100} = 2560$$

$$\frac{108P}{100} = 2560$$

$$\Rightarrow \boxed{P = 2000} \text{ Rs}$$



- ⑪ Ram borrow a sum of Rs 6300 from sita at the rate of 14% per annum for 3 years. He added some more money in it and lent it to geeta at 16% per annum for 3 years. In this process he earn a total profit of Rs 618. find how much amount does he added?

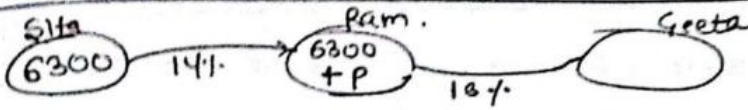

(245)

$$\frac{(6300+P) \times 16 \times 3}{100} - \frac{6300 \times 14 \times 3}{100} = 618 \Rightarrow P = 500 \text{ Rs.}$$

OR Ram saves 618 in 3 years.
 So, in 1 year = $\frac{618}{3} = 206 \text{ Rs}$
 saving = 16% - 14% = 2% of 6300
 $6300 \times \frac{2}{100} = 126 \text{ Rs}$

diff of saving
 $206 - 126 = 80 \text{ Rs}$. This diff
 is becoz of amt P invested
 by Ram.
 $\frac{P \times 16 \times 3}{100} = 80 \Rightarrow P = 500 \text{ Rs}$

(12) If a certain ~~sum~~ sum of money becomes 8 times of itself in 3 years. In how much time it will be 64 times of itself.

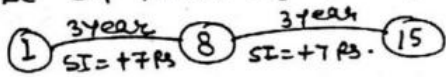

7 Rs — SI = 3 years
 63 Rs — SI = $\frac{3}{7} \times 63 = 27 \text{ years}$ Ans

* P = 1 Rs
 SI = 63 Rs
 Amt = 64 Rs, so
 64 times in
 27 years.

(13) A certain sum of money become double of itself in 6 years on SI. In what time it will be 10 times of itself.

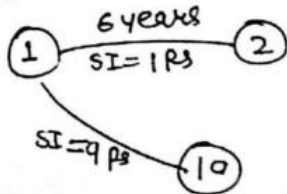

1 Rs — SI = 6 years
 9 Rs — SI = 6x9 = 54 years.



(14) A certain sum @ certain rate percent per annum simple interest becomes Rs 2100 in two years and Rs 2250 in 5 years. find Principal & rate percent.

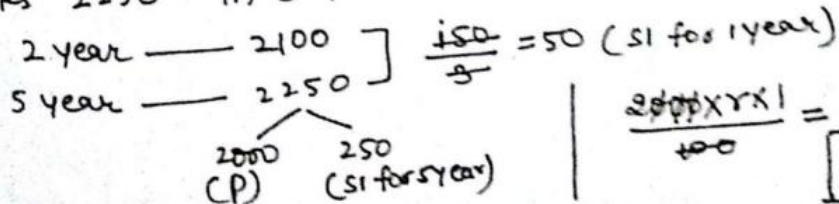

$$\frac{2000 \times r \times 1}{100} = 50 \Rightarrow r = \frac{5}{2} \%$$

(15) if a certain sum of money invested for a 246 certain time it amounts to Rs 350 @ 5% per annum, and it amounts to Rs 250 @ 3% per annum. find the time and principal?

$$\begin{array}{l} P \text{ --- } t \text{ --- } 5\% = 350 \left\{ \begin{array}{l} P \\ SI \end{array} \right. \\ P \text{ --- } t \text{ --- } 3\% = 250 \left\{ \begin{array}{l} P \\ SI \end{array} \right. \end{array} \quad \left. \vphantom{\begin{array}{l} P \\ P \end{array}} \right\} \frac{100}{2\%} = 50$$

$\begin{array}{l} 100 (P) \\ 150 (SI) \end{array}$

$$\frac{100 \times 1 \times t}{100} = 50$$

$$t = 50 \text{ years}$$

(16) if a certain sum of money amounts 10,000 in 5 years and Rs 10,800 in 7 years at a certain rate of interest. find rate percent.

$$\begin{array}{l} 5 \text{ years --- } 10,000 \text{ --- } P + SI(5 \text{ years}) \\ 7 \text{ years --- } 10,800 \text{ --- } P + SI(7 \text{ years}) \end{array} \quad \left. \vphantom{\begin{array}{l} P \\ P \end{array}} \right\} \begin{array}{l} \text{diff of SI of} \\ = 800 \text{ 2 years} \end{array}$$

$$\frac{800}{2} = 400 = SI \text{ for 1 year.}$$

$$P = 10,800 - 7(400) = 8000$$

$$\frac{800 \times 1 \times r \times 1}{100} = 400$$

$$r = 5\%$$

(7) A man deposit a total amt. of 65,000 in 3 banks A, B and C at the rate of simple interest 12%, 16% and 18% respectively. and earn a total SI of Rs 10,180 in one year. If the amount invested in bank A was $7\frac{2}{3}\%$ of amount invest in bank C. find the amt. invested in bank B.

(8) A man Invested a certain sum of Rs 80,000 in 3 banks A, B and C @ 15%, 16% and 27%. Amt. invested in bank A is 20% of the amt. invested in C. find the amount invested in bank B if he earn a interest of Rs 36,400 SI in two years.

$C = 5x$
 $A = x$
 $B = 80,000 - 6x$

$$\frac{x \times 15 \times 2}{100} + \frac{(80,000 - 6x) \times 16 \times 2}{100} + \frac{5x \times 27 \times 2}{100} = 36,400$$

$x = 10,000$

$C = 5 \times 10,000 = 50,000$
 $A = x = 10,000$
 $B = 80,000 - 60,000 = 20,000$ Ans

(9)

A C

15% 27%

1 : 5

27-15 = 12

1 : 5

2 : 10

80000

60,000

B A+C

16% 16%+9%

$16 \times 80,000 = 12800$
 $(A+C) \times 9 = 5400$
 $A+C = 60,000$

$14\% \text{ SI} = 18200$
 $\quad \quad \quad = 12800$

 $\quad \quad \quad = 5400$

Soln-17

$$A = 7\frac{3}{7}\% \cdot C$$

248

$$\frac{A}{C} = \frac{50\cancel{0}}{70\cancel{0}} = \frac{5x}{7x}$$

$$\begin{aligned} A &= 5x \\ C &= 7x \\ B &= 65000 - 12x \end{aligned}$$

$$\frac{5x \times 12}{100} + \frac{(65000 - 12x) \times 16}{100} + \frac{7x \times 18}{100} = 10180$$

$$\Rightarrow \frac{2}{100} (5x \times 6 + (65000 - 12x) \times 8 + 7x \times 9) = \frac{5090}{10180}$$

$$30x + 520000 - 96x + 63x = 509000$$

$$3x = 11000$$

$$x = \frac{11000}{3}$$

$$\begin{aligned} \therefore B &= 65000 - 12 \times \frac{11000}{3} \\ &= 21000 \text{ Ans.} \end{aligned}$$

(19) Rs 26,000 is invested in two parts in such a way that the SI from 1st part @ 10% per annum for 5 years is equal the simple interest on 2nd part @ 9% per annum for 6 years. find both the parts.

(20) Rs 12,600 is invested in 3 parts in such a way that SI on 1st part @ 2% per annum for 3 years is equal to SI on 2nd part @ 3% per annum for 4 years is equal to SI on 3rd part @ 4% per annum for 5 years are equal. find the SI on each part.

(21) Rs 18,750 is invested by a man in the bank account of his two sons whose ages are 12 years and 14 years in such a way that they will get equal amount at an age of 18 years @ 5% per annum? find the share of younger child.

solutions

249

$$(19) \frac{A \times 10 \times 5}{100} = \frac{B \times 9 \times 6^3}{100}$$

$$25A = 27B$$

$$\frac{A}{B} = \frac{27}{25}$$

52 unit — 26,000

1 unit — 500 Rs

$$A = 27 \times 500 = 13,500 \text{ Rs}$$

$$B = 25 \times 500 = 12,500 \text{ Rs}$$

Ans

(20)

12,600

$$\frac{A \times 2 \times 3}{100} = \frac{B \times 3 \times 4}{100} = \frac{C \times 4 \times 5}{100}$$

$$3A = 6B = 10C = 30 \text{ (let Lcm of 3, 6, 10)}$$

$$\begin{matrix} \downarrow & & \downarrow & & \downarrow \\ A & ; & B & ; & C \\ 10 & ; & 5 & ; & 3 \end{matrix}$$

18 unit — 12,600 Rs

1 unit — 700 Rs

$$A = 7000, B = 3500, C = 2100.$$

$$\text{SI on 1st part} = \frac{7000 \times 2 \times 3}{100} = 420 \text{ Rs} = \text{2nd \& 3rd part}$$

(21)

12 year

14 year

$$\frac{Y}{P} + \frac{Y \times 5 \times 6}{100} = \frac{E}{P} + \frac{E \times 5 \times 4}{100}$$

Y = Younger

E = Elder

$$\frac{130Y}{100} = \frac{120E}{100}$$

$$\frac{Y}{E} = \frac{12}{13}$$

25 unit — 18750

1 unit — 750

$$\text{Younger} = 12 \times 750$$

$$= 9000 \text{ Rs}$$

(22) A person invest money in 3 diff scheme for 6 years, 10 year, 12 years @ 10%, 12% and 15% SI respectively. At the completion of each scheme he gets the same interest, find the ratio of his investment.

$$\frac{P_1 \times 10 \times 6}{100} = \frac{P_2 \times 12 \times 10}{100} = \frac{P_3 \times 15 \times 12}{100}$$

$$1 \cdot P_1 = 2 P_2 = 3 P_3$$

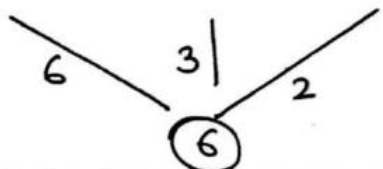

6 : 3 : 2 Ans

(23) If Rs 64 amount to Rs 83.20 in 2 years. What will Rs 86 amounts to in 4 years @ the same rate percent per annum.

$$\begin{array}{r} 83.20 \\ -64.00 \\ \hline \text{SI} = 19.20 \text{ Rs} \end{array} \qquad \frac{64 \times r \times 2}{100} = 19.20$$

$$r = 15\%$$

$$\Rightarrow \frac{86 \times 15 \times 4}{100} = \frac{258}{5} = 51.6 \text{ Rs}$$

$$\text{Amount} = 86 + 51.6 = 137.6 \text{ Rs} \quad \underline{\text{Ans}}$$



(24) A man borrowed a total amt. of Rs 30,000, A part of it on SI @ 12% per annum & remaining on SI @ 10% p.a. if at the end of 2nd year, he paid in all Rs 36,480 to settle the loan amt. What was the amt. borrowed at 12% per annum.

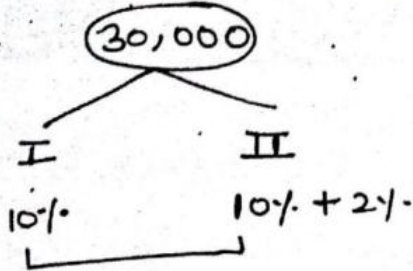

$$SI \text{ for 1 year} = \frac{6480}{2} = 3240$$

251

$$\frac{10}{100} \times 30,000 = 3000$$

$$\begin{array}{r} 3240 \\ - 3000 \\ \hline 240 \end{array}$$

$$II \times \frac{2}{100} = \frac{120}{240}$$

$$II = 12,000 \text{ Rs. } \underline{\underline{\text{Ans}}}$$

25) A moneylender finds that due to a ~~fall~~ decrease in the rate from 13% to 12½%, his yearly income reduced by Rs 104. what is his capital?

$$P \times \frac{1}{2} \% = 104$$

$$P \times \frac{1}{200} = 104$$

$$P = 20800 \text{ Rs. } \underline{\underline{\text{Ans}}}$$



$$\text{Annual Income/Payment/Installment} = \frac{\text{Due Debt} \times 100}{100t + \frac{rt \times (t-1)}{2}}$$

26) What annual payment will discharge a debt of Rs 944 in 4 annual equal installments at the rate of 12% p.a on SI.

$$\frac{944 \times 100}{400 + \frac{12 \times 4 \times 3}{2}} = \frac{944 \times 100}{400 + 72}$$

$$\Rightarrow \frac{944 \times 100}{472} \Rightarrow 200 \text{ Rs} \quad \underline{\text{Ans}}$$

27) what annual installment will discharge a debt of Rs 2210 due in 4 years @ 7% SI.

$$\frac{2210 \times 100}{400 + \frac{7 \times 4 \times 3}{2}} = \frac{2210 \times 100}{442} = 500 \text{ Rs} \quad \underline{\text{Ans}}$$

28) The annual payment of Rs 700 in 5 yr @ 10% p.a SI will discharge a debt of what amount.

$$700 = \frac{D \times 100}{500 + \frac{10 \times 5 \times 4}{2}}$$

$$700 = \frac{D \times 100}{600} \quad D = 4200 \text{ Rs} \quad \underline{\text{Ans}}$$

or

700	280
700	210
700	140
700	70
700	0
<u>3500</u>	<u>700</u>

$$\frac{7000 \times 10}{100} = 700 \text{ Rs} \downarrow 140 \text{ SI}$$

$$3500 + 700 = 4200 \text{ Rs} \quad \underline{\text{Ans}}$$

True Discount

253

Principal	→	Present worth
SI	→	True discount
Amount	→	Due Debt.

29) Find the present worth and true discount recurring 5% p.a SI of Rs 10,000 due in 5 years.

Present worth = P

True/Discount SI = $\frac{P \times 5 \times 5}{100} = \frac{25}{100} P$

Due Debt = $P + \frac{25P}{100} = 10,000$

$\frac{25P}{100} = 10,000 - P$

$P = 80,000 \text{ Rs}$

Present worth = 8000

True discount = $10,000 - 8000 = 2000 \text{ Rs.}$

30) Find the present worth of Rs 9950 due $3\frac{1}{4}$ years, hence @ $7\frac{1}{2}\%$ p.a SI. Also find the true discount.

Let Present worth = 100

T.D = $\frac{100 \times 15 \times 13}{100 \times 2 \times 4} = \frac{195}{8} \text{ unit}$

Due Debt = $100 + \frac{195}{8} = \frac{995}{8} \text{ unit} \quad \text{—————} \quad 9950$
 $1 \text{ unit} \quad \text{—————} \quad 80 \text{ Rs}$

∴ Present worth = $100 \times 80 = 8000 \text{ Rs}$

True discount = $\frac{195}{8} \times 80 = 1950 \text{ Rs.}$ Ans

③ find the diff b/w True discount and SI 254
on Rs 2400 due after 5 years @ 4% per annum.

$$\text{Present worth} = 100 \text{ Rs (let)}$$

$$\text{T.D} = \frac{100 \times 4 \times 5}{100} = 20 \text{ unit}$$

$$\text{Due Debt} = 100 + 20 = 120 \text{ unit} \rightarrow 2400$$

1 unit \rightarrow 20 Rs

$$\text{T.D} = 20 \times 20 = 400 \text{ Rs}$$

$$\text{Present worth} = 100 \times 20 = 2000 \text{ Rs.}$$

$$\text{SI} = \frac{2400 \times 4 \times 5}{100} = 480$$

$$\text{SI} - \text{TD} = 480 - 400 = 80 \text{ Rs} \quad \underline{\text{Ans.}}$$

Download All Subject Free PDF

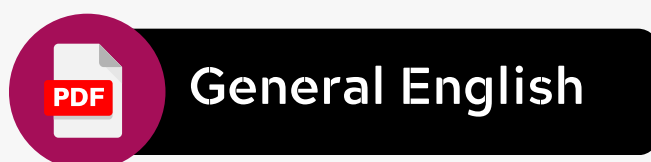
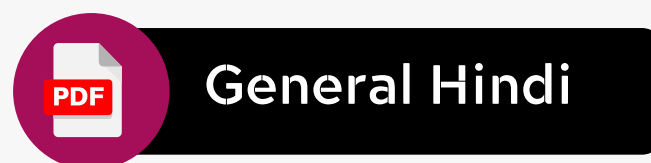
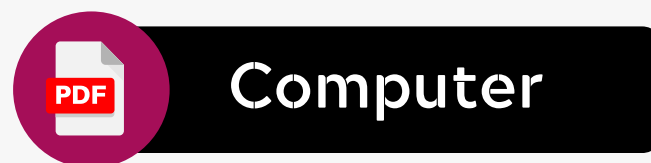
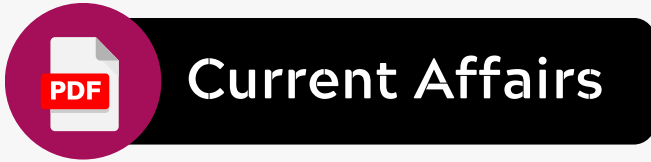
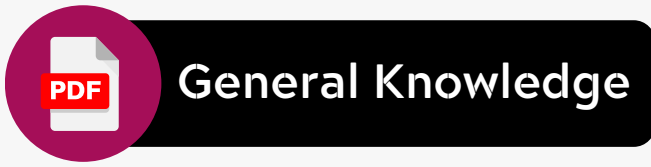



Join Our Best Course

GK Trick By
Nitin Gupta

Current Affairs

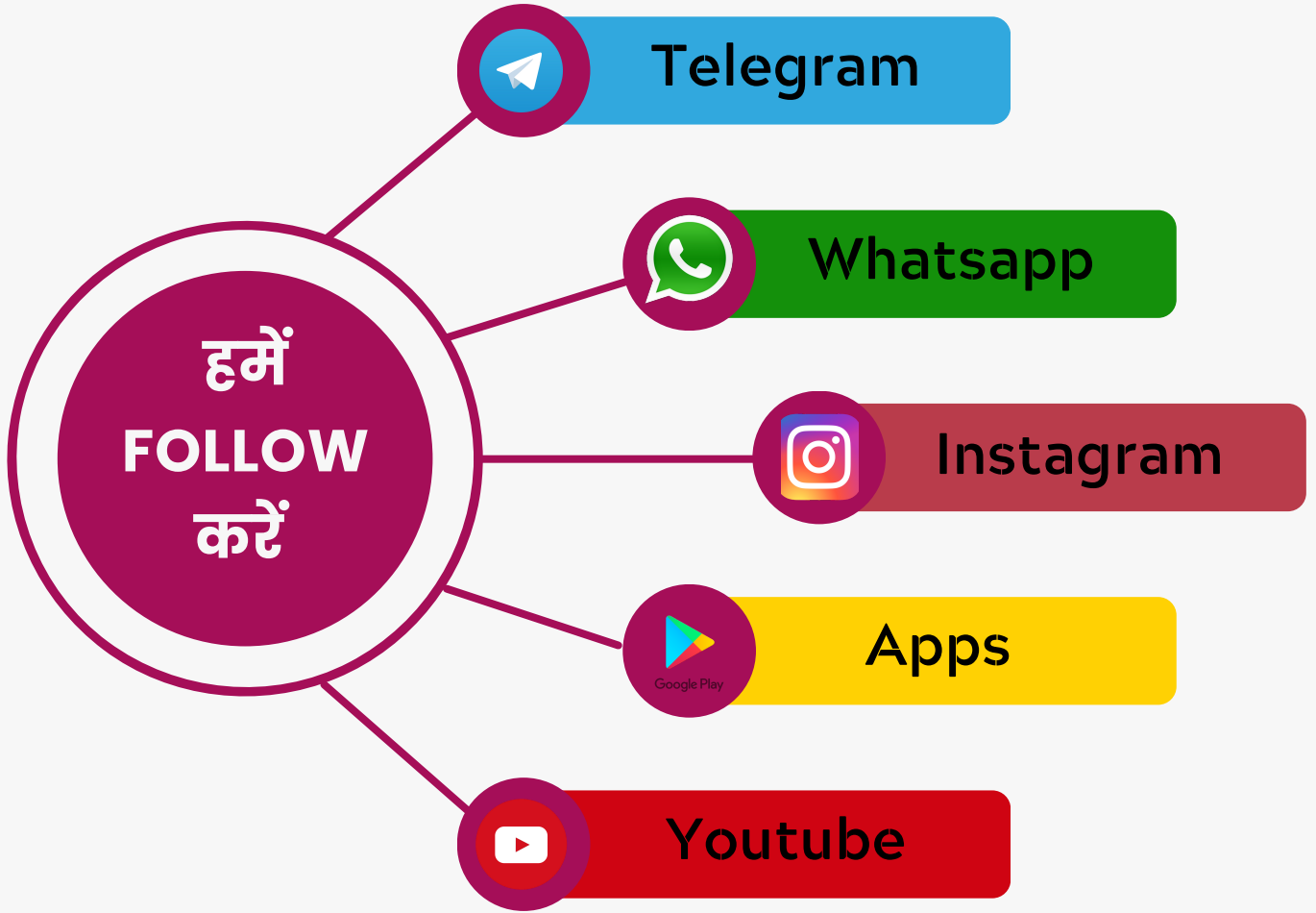
Daily Current Affairs PDF, Best Test Series, Best GK PDF के लिए हमें Follow करें



 GK Trick By Nitin Gupta
The Ultimate Key to Success.

Welcome To

GK TRICK BY NITIN GUPTA APP

यहाँ पर आपको मिलेगा

- ✓ Best PDF Notes For All Exams
- ✓ Best Test Series For All Exams
- ✓ Daily Current Affairs PDF
- ✓ सभी Course बहुत ही कम Price पर
- ✓ सभी Test Detail Discription के साथ व Analysis करने को सुविधा



**ADVANCE MATHS
(VOLUME-2)**

GoCareeek.in

CLASS
34

1

NUMBER SYSTEM & ALGEBRA

* Remainder Theorem :-

1 $\frac{17}{6}$ ⁺⁵ ₋₁ R=5

2 $\frac{27}{10}$ ⁺⁷ ₋₃ R=7

3 $\frac{3}{5}$ ⁺³ ₋₂ R=3

4 $\frac{9}{13}$ ⁺⁹ ₋₄ R=9



5 $\frac{13}{9}$ ⁺⁴ ₋₅ R=4

6 $\frac{49}{9}$ ⁺⁴ ₋₅ R=4

7 $\frac{49 \times 65}{9}$ ⁺⁴ ₋₂ ⁺² R=8

OR $\frac{49 \times 65}{9} = \frac{35}{9} = 8$

OR $\frac{35}{9} = -1 = 9-1 = 8$

OR $\frac{49 \times 65}{9} = \frac{-28}{9} = -1 \Rightarrow 9-1 = 8$ Ans.

GoCareer.in

8 $\frac{65}{9}$ ⁺² ₋₇ R=2

9 $\frac{54 \times 73}{8}$ ⁺⁶ ₋₁ R=6

OR $\frac{54 \times 73}{8} = -2 \Rightarrow 8-2 = 6$ Ans.

10 $\frac{1753 \times 1749 \times 83 \times 171}{17}$ ⁺² ⁻² ⁻² ⁺¹ R=8

$\frac{1! + 2! + 3! + 4! + 5! + 6! + \dots + 100000!}{8}$, R=0

$4! = \frac{4 \times 3 \times 2 \times 1}{8}$, R=0

$5! = \frac{5 \times 4 \times 3 \times 2 \times 1}{8}$, R=0

4 से आगे जितने भी factorial हैं सबका R=0 आसगा क्योंकि सब में 8 का multiple होगा.

11 $\frac{1 + 12 + 13 + \dots + 100000}{10}$ find unit digit

$$\frac{\overset{+1}{1} + \overset{+2}{12} + \overset{-1}{13} + \overset{+4}{14} + \overset{0}{15} + \dots + 100000}{10}$$

R=3 ∴ unit digit = 3

12 $\frac{1 + 12 + 13 + 14 + \dots + 1000}{12}$ find Remainder.

R = 9



13 $12899 \times 96 \times 997$ find last two digits.

$$\frac{\overset{-1}{12899} \times \overset{-4}{96} \times \overset{-3}{997}}{100} = -12 \Rightarrow 100 - 12 = 88$$

R=88 ∴ last two digit = 88

→ if a no. is divided by 10, the remainder obtained is the unit place of that no.
 → if a no. is divided by 100, the remainder obtained is the last two digit of that no.

14 $\frac{98 \times 17373 \times 153 \times 96 \times 127}{100}$ find last two digits.

$$\frac{98 \times 17373 \times 153 \times \overset{24}{96} \times 127}{100}$$

$$\frac{\overset{-2}{98} \times \overset{-2}{17373} \times \overset{+3}{153} \times \overset{-1}{24} \times \overset{+2}{127}}{25}$$

= -24 = 25 - 24 = 1 × 4 = 4

Remainder = 4

∴ last two digits = 04 Ans

↓
starting में 4 से simplify किया था.

⊕ $\frac{24}{9}$, R = 6.

Now, $\frac{8 \times 24}{9 \times 3} = \frac{8}{3}$, R = (+2) × 3 = 6

जिस no. से simplify करते हैं बाद में उसी से multiply करते हैं तब सही remainder आयेंगा, नहीं तो गलत होगा.

(15) $37 \times 53 \times 65 \times 39 \times 1352 \times 48 \times 73$. find last two digits ?

$$37 \times 53 \times \overset{13}{\cancel{65}} \times 39 \times 1352 \times \overset{12}{\cancel{48}} \times 73$$



5, 4

$$\begin{array}{cccccccc} +00 & & & & & & & \\ -20 & & & & & & & \\ +05 & & & & & & & \\ \hline +2 & -2 & -2 & & -1 & +2 & +2 & -2 \\ 37 \times 53 \times 13 \times 39 \times 1352 \times 12 \times 73 & = & \frac{64}{5} & = & 4 \end{array}$$

simplified by 20

$$R = 4 \times 20 = 80$$

last two digits = 80.

By.
Pardeep Chhokker
7206446517

(16) $\frac{(35)^{113}}{9} = (-1)^{113} = -1, R = 9-1 = 8$

$\frac{(37)^{113}}{9} = (1)^{113} = +1$

odd = -
even = +

(15) $\frac{2^{33}}{9} = \frac{(2^3)^{11}}{9} = \frac{(8)^{11}}{9} = (-1)^{11} = -1 \Rightarrow 9-1 = 8$

(17) $\frac{2^{34}}{9} = \frac{2^1 \times 2^{33}}{9} = \frac{2^1 \times (8)^{11}}{9} = -2 \Rightarrow 9-2 = 7$

GoCareer.in

$$(18) \frac{7^{512}}{400} = \frac{(7^4)^{128}}{400} = \frac{(2401)^{128}}{400} = 1$$

$$(19) \frac{2^{110}}{9} = \frac{2^2 \times 2^{108}}{9} = \frac{4 \times 2^{108}}{9} = \frac{4 \times (2^3)^{36}}{9} = 4 \text{ Ans}$$

CLASS
35

Pardeep Chhokker
7206446517.

$$(20) \frac{4^{48}}{33} = \frac{(2^2)^{48}}{33} = 2^{96} \rightarrow 2^1 \times 2^{95} \rightarrow 2 \times (2^5)^{19}$$

$$\rightarrow \frac{2^2 \times (32)^{19}}{33} \rightarrow -2 \rightarrow 33-2 \Rightarrow 31 \text{ Ans}$$

$$(21) \frac{(83)^{115} + 12}{84} = 11$$

GoCareer.in

$$(22) \frac{2^{99}}{16} \rightarrow \frac{2^4 \times 2^{95}}{16} \rightarrow \frac{16 \times 2^{95}}{16} \Rightarrow R=0$$

$$(23) \frac{2^{99}}{10} = \frac{2 \times 2^{98}}{10} = \frac{2^{98}}{5} = \frac{(2^2)^{49}}{5}$$

$$\frac{(4)^{49}}{5} = -1 \Rightarrow 5-1 \Rightarrow 4 \times 2 \Rightarrow 8$$

$$(24) \frac{5^{500}}{500} = \frac{5^3 \times 5^{497}}{125 \times 4} = \frac{5^{497}}{4} = 1 \times 125 = 125 \text{ Ans}$$

simplified by 2 in the starting.
↓
simplified by 125 in starting.

(25)
$$\begin{array}{r} \overset{-1}{(35)} \overset{-2}{11938769} \\ \times 7 \\ \hline 9 \end{array} = +2$$

(26)
$$\begin{array}{r} 123456789101112131415 \\ \hline 16 \end{array}$$

$\Rightarrow \frac{1415}{16} = 7$

$R = 7.$

Any no. divisible by 2 if last 1 digit divides
 Any no. divisible by 4 if last 2 digit divides
 Any no. divisible by 8 if last 3 digit divides
 Any no. divisible by 16 if last 4 digit divides

(7)
$$\begin{array}{r} 12345 \dots \dots \dots 41 \text{ digits} \\ \hline 8 \end{array}$$

$\Rightarrow \frac{041}{8} \Rightarrow +1$
 ~~$R = 1$~~

$2^5 = 32$
$2^6 = 64$
$2^7 = 128$
$2^8 = 256$
$2^9 = 512$
$2^{10} = 1024$

1 to 9 \rightarrow Each no. has 1 digit

After 9 \rightarrow Each no. has 2 digits (10, 11, 12...)

$$\frac{41}{-9} = \frac{32}{2} = 16 \text{ nos}$$

 32 digits

$\therefore \frac{12345 \dots \dots \dots 232425}{8}$

$\therefore \begin{array}{r} 8 \overline{) 425} \text{ (53)} \\ \underline{40} \\ 25 \\ \underline{24} \\ 1 \end{array}$

$R = \underline{1} \quad \underline{\underline{\text{Ans}}}$

GoCareer.in

(28)

$$\frac{1234 \dots 57 \text{ digits}}{16}$$

$$57-9 = \frac{48}{2} = 24+9 = 33 \text{ numbers}$$

$$\frac{1234 \dots 3233}{16} \Rightarrow \frac{3233}{16} \Rightarrow 1 \text{ Ans}$$

(29)

$$\frac{12345 \dots 76 \text{ digits}}{16}$$

if 75 digits $\rightarrow 75-9 = \frac{66}{2} = 33+9 = 42 \text{ numbers}$
 + 1 digit more
 i.e 4

$$\frac{12345 \dots 4041424}{16}$$

$$\Rightarrow \frac{1424}{16} \Rightarrow R=0$$

(30)

$$\frac{66666666 \dots 45 \text{ times}}{37}$$

7 pairs of 666666 \Rightarrow 42 times

$$\begin{array}{r} \therefore 37 \overline{) 666} 18 \\ \underline{296} \\ 296 \\ \underline{296} \\ R=0 \end{array}$$

If Any no. is written 6 times like (111111, 222222, 666666) it will exactly divide by 7, 11, 13, 37.

(#)

divide by 3 \rightarrow sum of all digit divide by 3

9 \rightarrow sum of all digits divide by 9

27 \rightarrow sum of All digits divide by 27

6 \rightarrow Number divide by 2 and 3 both.

(*) Divide by 7

$$\begin{array}{r} 5387 \overline{) 6} \\ \underline{-12} \\ 537 \\ \underline{-10} \\ 527 \\ \underline{-14} \\ 38 \end{array}$$

7
Any no. written like
3737, 2525, 2323 will
be divisible by 101.

→ not divisible by 7
∴ 53876 is not divisible by 7.

(#) 65432577

make pairs from right sides (3 digits)

Add alternate pairs

$$577 + 65 = 642$$

subtract from 3rd pair

$$\begin{array}{r} 642 \\ - 432 \\ \hline 210 \end{array}$$

→ divisible by 7

∴ 65432577 is divisible by 7.

GoCareer.in

(#) Divisible by 11

2 3 4 5 6 7 8

add alternate digits = 2 + 4 + 6 + 8 = 20

3 + 5 + 7 = 15

Then subtract

$$\begin{array}{r} 20 \\ - 15 \\ \hline 5 \end{array}$$

if this diff is 0 or multiple of 11, then the no. will be divide by 11 otherwise not.

71940

$$\begin{array}{r} 16 \\ - 5 \\ \hline 11 \end{array}$$

→ divisible by 11

∴ 71940 is divisible by 11.

(31) $\frac{10^1 + 10^2 + 10^3 + 10^4 + \dots + 10^{100}}{6}$, find remainder

$$\frac{\overset{+4}{10^1} + \overset{+4}{10^2} + \overset{+4}{10^3}}{6} = \frac{12}{6} = 0$$

After every 3 terms remainder will be zero.

\therefore so upto 10^{99} remainder is zero.

$$\frac{10^{100}}{6} = 4$$

GoCareer.in

(32) $\frac{10^1 + 10^2 + 10^3 + \dots + 10^{11}}{6}$

\therefore upto 10^9 remainder is zero.

$$\frac{\overset{+4}{10^{10}} + \overset{+4}{10^{11}}}{6} = \frac{8}{6} = 2$$

(33) $(23^{10} - 1024)$ not divides by

~~A) 5~~

C) 4

~~B) 3~~

~~D) 7~~

$$(23^{10} - 2^{10})$$

$$23-2 = 21$$

```

    21
   / | \
  1  3  7
  
```

$$23+2 = 25$$

```

    25
   /  \
  5  25
  
```

$(a^n - b^n)$
 $n \rightarrow$ even no.
then this no. divides
by $(a-b)$ & $(a+b)$

this no. is not divided by 4.

CLASS
36

Pardeep Chhokker
7206446517.

9

(34) $(3^{41} + 7^{82})$ not divides by

A) 3 ~~B) 4~~
~~C) 13~~ D) 26

$$3^{41} + (7^2)^{41}$$

$$3^{41} + 49^{41}$$

$$49 + 3 = 52$$

1, 13, 26, 4.

∴ not divided by 3.

$a^n + b^n$
 $n \rightarrow \text{odd}$
then $a^n + b^n$ divides
by $(a+b)$

(35)
$$\begin{array}{r} (+4)^{23} \quad 0 \quad (-4)^{23} \\ 27^{23} + 23^{23} + 19^{23} \\ \hline 23 \end{array}$$

find Remainder.

= 0

GoCareer.ir

(OR)

$$\frac{27^{23} + 19^{23}}{23}$$

⇒

$$27 + 19 = 46 \begin{array}{l} \swarrow 1 \\ \searrow 2 \\ \quad 23 \end{array}$$

R = 0

<p># if $(a^n - b^n)$ $n \rightarrow \text{even}$ divides by $(a-b), (a+b)$ $a^2 - b^2 = (a+b)(a-b)$</p>	<p>$a^n - b^n$ $n \rightarrow \text{odd}$ divides by $(a-b)$ $a^3 - b^3 = (a-b)(a^2 + ab + b^2)$</p>	<p>$a^n + b^n$ $n \rightarrow \text{odd no.}$ divides by $(a+b)$ $a^3 + b^3 = (a+b)(a^2 - ab + b^2)$</p>
--	--	--

#

$$(102)^3 = 106 / 12 / 08 = 1061208$$

$$(104)^3 = 112 / 48 / 64 = 1124864$$

$$(105)^3 = 115 / 75 / 25 = 1157625$$

$$(106)^3 = 118 / 08 / 16 = 1191016$$

36) if $x = 106$

Then $x(x^2 - 3x + 3) = ?$

where x appears two times,
that means $(a+b)$ or $(a-b)$ का
cube होगा।

$$(a+b)^3 = a^3 + 3a^2b + 3ab^2 + b^3$$

$$(a-b)^3 = a^3 - 3a^2b + 3ab^2 - b^3$$

$$x(x^2 - 3x + 3)$$

$$x^3 - 3x^2 + 3x - 1 + 1$$

$$(x-1)^3 + 1$$

$$(105)^3 + 1 \Rightarrow 1157625 + 1 \Rightarrow 1157626 \text{ Ans}$$

GoCareer.in

37) if $x = 99$

then $x(x^2 + 12x + 48) = ?$

$$x^3 + 12x^2 + 48x + \underline{64} - \underline{64}$$

$$\downarrow \quad \downarrow \quad \downarrow$$

$$a^3 \quad 3x^2 \cdot 4 \quad 3ab^2 + b^3$$

$$(x+4)^3 - 64$$

$$1092727 - 64$$

दो बार 3 या 3 का
multiple किये तो
 $(a-b)$ या $(a+b)$ का
cube बताओ।



38)

$$\frac{1}{\sqrt[3]{25} - \sqrt[3]{5} + 1} = A\sqrt[3]{25} + B\sqrt[3]{5} + C \quad A+B+C =$$

$$\frac{1(5^{\frac{1}{3}} + 1)}{\left[\begin{array}{ccc} (5^{\frac{1}{3}})^2 & - 5^{\frac{1}{3}} \times 1 & + (1)^2 \\ \downarrow & \downarrow & \downarrow \\ a^2 & - ab & b^2 \end{array} \right] (5^{\frac{1}{3}} + 1)}$$

$$\begin{aligned} \sqrt[3]{25} &= (25)^{\frac{1}{3}} \\ &= (5^2)^{\frac{1}{3}} \\ &= (5)^{\frac{2}{3}} \\ &= (5^{\frac{1}{3}})^2 \end{aligned}$$

$$a^3 + b^3 = (a+b)(a^2 - ab + b^2)$$

$$a^3 - b^3 = (a-b)(a^2 + ab + b^2)$$

$$\Rightarrow \frac{\sqrt[3]{5} + 1}{(\sqrt[3]{5})^3 + (1)^3} \Rightarrow \frac{2\sqrt[3]{5} + 1}{6}$$

$$\Rightarrow \frac{1}{6} \sqrt[3]{5} + \frac{1}{6} = A\sqrt[3]{25} + B\sqrt[3]{5} + C$$

$$\begin{matrix} A & B & C \\ 0 & \frac{1}{6} & \frac{1}{6} \end{matrix} \Rightarrow \left(\frac{1}{3}\right) \text{ Ans.}$$

39) $\frac{1}{\sqrt[3]{9} + \sqrt[3]{3} + 1} = A\sqrt[3]{9} + B\sqrt[3]{3} + C ; A+B-C = ?$

$$\frac{1(\sqrt[3]{3}-1)}{(\sqrt[3]{3}-1)[(\sqrt[3]{3})^2 + 2\sqrt[3]{3} \times 1 + (1)^2]}$$

$$\Rightarrow \frac{3\sqrt[3]{3}-1}{(\sqrt[3]{3})^3 - (1)^3}$$



By.
Pardeep Chhokker
7206446517

$$\frac{1}{2} \sqrt[3]{3} - \frac{1}{2}$$

$$A = 0$$

$$B = \frac{1}{2}$$

$$C = -\frac{1}{2}$$

$$A+B-C = \frac{1}{2} - (-\frac{1}{2}) = 1 \text{ Ans}$$

$x = 7 + 4\sqrt{3}$	$x = \sqrt{3} - \sqrt{2}$	$x = 5 - 2\sqrt{6}$
$\frac{1}{x} = 7 - 4\sqrt{3}$	$\frac{1}{x} = \sqrt{3} + \sqrt{2}$	$\frac{1}{x} = 5 + 2\sqrt{6}$

अगर दो no. के square का diff 1 हो तो उनके conjugate में सिर्फ sign change होगा

40) $x = \frac{1}{7+4\sqrt{3}}$, $y = \frac{1}{7-4\sqrt{3}}$; $\frac{1}{x+1} + \frac{1}{y+1} = ?$

$$\frac{1}{x} = \frac{1}{7-4\sqrt{3}}$$

$$y = \frac{1}{x}$$

$$\frac{1}{x+1} + \frac{1}{\frac{1}{x}+1}$$

$$\frac{1}{x+1} + \frac{x}{1+x}$$

$$\frac{\cancel{1+x}}{x+1} = \textcircled{1} \text{ Ans}$$

41) $x = (\sqrt{3} + \sqrt{2})^{-3}$ | $y = (\sqrt{3} - \sqrt{2})^{-3}$ | $(x+1)^{-1} + (y+1)^{-1} = ?$

$$\frac{1}{x} = (\sqrt{3} - \sqrt{2})^{-3}$$

$$\frac{1}{x} = y$$

$$\frac{1}{x+1} + \frac{1}{y+1}$$

$$\frac{1}{x+1} + \frac{1}{\frac{1}{x}+1}$$

$$\frac{\cancel{1+x}}{x+1} = \textcircled{1} \text{ Ans}$$

42) $x = 7 + 4\sqrt{3}$ | $x + \frac{1}{x} = ?$

$$\frac{1}{x} = 7 - 4\sqrt{3}$$

$$\therefore x + \frac{1}{x} = 14$$

43) if $x = 14$

$$x^5 - 15x^4 + 15x^3 - 15x^2 + 15x$$

$$\cancel{x^5} - 14\cancel{x^4} - \cancel{x^4} + 14\cancel{x^3} + \cancel{x^3} - 14\cancel{x^2} - \cancel{x^2} + 14\cancel{x} + \cancel{x}$$

$$x = 14$$

$$\textcircled{14} \text{ Ans}$$

if $x=12$

$$x^6 - 13x^5 + 13x^4 - 13x^3 + 15x^2 - 13x + 5 = ?$$

$$\underbrace{x^6 - 13x^5 + 13x^4 - 13x^3 + 13x^2 - 13x + 5}_0 + 2x^2$$

$$-x + 5 + 2x^2$$

$$\Rightarrow 2(12)^2 + 5 - 12$$

$$\Rightarrow 281$$

Recurring digit

$$0.5555\dots = 0.\overline{5}$$

$$0.676767\dots = 0.\overline{67}$$

$$0.65\overline{7} = 0.6577\dots$$

$$2.6\overline{5} = 2 + 0.6\overline{5}$$

$$\overline{2.65} = -2 + 0.6\overline{5}$$

$$0.\overline{5} = \frac{5}{9}$$

$$0.\overline{56} = \frac{56}{99}$$

$$0.\overline{567} = \frac{567}{999}$$

$$0.4\overline{5} = \frac{45-4}{90} = \frac{41}{90} \rightarrow$$

$$0.5\overline{78} = \frac{578-5}{990} = \frac{573}{990}$$

जितने बार \rightarrow अंकी 9
जिसके बार नहीं -
उत्तरे zero.

$$2.5\overline{78}$$

$$2 + 0.5\overline{78}$$

$$2 + \frac{578-5}{990}$$

$$2 + \frac{573}{990}$$

$$2 \frac{573}{990}$$

(45)

$$\sqrt[3]{0.037}$$

$$\Rightarrow \sqrt[3]{\frac{37}{999}} \Rightarrow \sqrt[3]{\frac{1}{27}}$$

$$\Rightarrow \sqrt[3]{\left(\frac{1}{3}\right)^3} \Rightarrow \frac{1}{3} \Rightarrow 0.\overline{3}$$

(46) $(0.\overline{11} + 0.\overline{22}) \times 3$

$$\Rightarrow \left(\frac{11}{99} + \frac{22}{99}\right) \times 3 \Rightarrow \frac{33}{99} \times 3 \Rightarrow 1$$

(47)

$$3.\overline{12} + 5.\overline{34} + 2.\overline{16}$$

$$3 + \frac{12}{99} + 5 + \frac{34}{99} + 2 + \frac{16}{99}$$

$$\Rightarrow 10 + \frac{62}{99} \Rightarrow 10 \frac{62}{99} \Rightarrow 10.\overline{62}$$

(48)

$$2.\overline{856} + 3.\overline{74} + 5.\overline{8576}$$

2, 2, 1
LCM = 2

max. no's जिनमे बार नहीं है (3)	जितना LCM आर उतने no. चहाँ secure कर ले। ↓	कितने ची ले लो। जबरन नहीं है।
X X X	X X	X X X X
2. 8 5 6	5 6	5 6 5 6
3. 7 4 7	4 7	4 7 4 7
5. 8 5 7	6 6	6 6 6 6
1 2. 4 6 1	7 0	7 0 6 9

12.46170 Ans

option से

- 1) option में सबसे पहले ये देखो के जितना LCM आया है (2) उतने बार कितने options में है।
- 2) फिर बार से पहले 3 no's ये बार नहीं है।

OR

- ① जितने no's ये बार ही उनका LCM लेना है। (2, 2, 1)
LCM = 2. Ans में बार 2 no's पर ही होगा।
- ② अब ये देखो सबसे ज्यादा किन no. ये बार नहीं है। 5.8576 में 3 no's ये बार नहीं है।
∴ बार से पहले 3 no's आयेगे



GoCareer.in



(49)

$$2.5\bar{6} + 2.34\bar{5}$$

(191) → LCM = 1

	x	x		x			
	2	5	6	6	6	6	
	2	3	4	5	5	5	
	4	9	1	2	2	1	

4.91 $\bar{2}$ Ans

Number of factors

(#)

(5) 240

2	240
2	120
2	60
2	30
3	15
5	5
	1

$$240 \rightarrow 2^4 \times 3^1 \times 5^1$$

① No. of factors ⇒

$$5 \times 2 \times 2 = 20.$$

② sum of all factors ⇒

$$(2^0 + 2^1 + 2^2 + 2^3 + 2^4) \times$$

$$(3^0 + 3^1) \times (5^0 + 5^1)$$

$$\Rightarrow 31 \times 4 \times 6$$

$$= 744$$

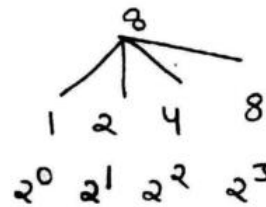

(factors are in GP)

$$8 \rightarrow 2^3$$

$$\text{Total factors} = \text{power} + 1 = 3 + 1 = 4$$

$$\therefore 8 \rightarrow 2^3 \times 2^0$$

Parvab Chokker
202445517



51

300

$$\begin{array}{r|l} 2 & 300 \\ \hline 2 & 150 \\ \hline 3 & 75 \\ \hline 5 & 25 \\ \hline 5 & 5 \\ \hline & 1 \end{array}$$

$$300 \rightarrow 2^2 \times 3^1 \times 5^2$$

$$\text{No. of factors} = 3 \times 2 \times 3 = 18$$

$$\text{sum of all factors} = (2^0 + 2^1 + 2^2) \times (3^0 + 3^1) \times (5^0 + 5^1 + 5^2)$$

$$7 \times 4 \times 31 = 868 \quad \underline{\underline{\text{Ans.}}}$$

52

$$2^2 \times 3^1 \times 5^2$$

$$\underline{\text{No. of even factor}} \Rightarrow 2 \times 2 \times 3 = 12$$

even no. की power में 1 odd नहीं करोगे।

$$\underline{\text{sum of even factor}} \Rightarrow (2^1 + 2^2) (3^0 + 3^1) (5^0 + 5^1 + 5^2)$$

$$6 \times 4 \times 31 = 744$$

even की power 0 consider नहीं करेंगे
odd का रेंज

$$\underline{\text{No. of odd factor}} \Rightarrow 2 \times 3 = 6 \quad \rightarrow (\text{even को नहीं लेंगे})$$

$$\underline{\text{sum of odd factor}} \Rightarrow (3^0 + 3^1) (5^0 + 5^1 + 5^2)$$

$$4 \times 31 = 124$$

(even को नहीं लेंगे)

53

$$360 \rightarrow 2^3 \times 3^2 \times 5^1$$

$$\begin{array}{r|l} 2 & 360 \\ \hline 2 & 180 \\ \hline 2 & 90 \\ \hline 3 & 45 \\ \hline 3 & 15 \\ \hline 5 & 3 \\ \hline & 1 \end{array}$$

$$\text{No. of odd factors} = 3 \times 2 = 6$$

$$\text{sum of odd factors} = (3^0 + 3^1 + 3^2) (5^0 + 5^1)$$

$$13 \times 6 = 78$$

sum of even factors =

$$(2^1 + 2^2 + 2^3) (3^0 + 3^1 + 3^2) (5^0 + 5^1)$$

$$14 \times 13 \times 6 = 1092$$

(54) $1728 \rightarrow 2^6 \times 3^3$

2	1728
2	864
2	432
2	216
2	108
2	54
3	27
3	9
3	3
	1

No. of factors = $7 \times 4 = 28$

GoCareer.in

Number of prime factor

(#) $a^x \times b^y \times c^z \dots$ a, b, c \rightarrow prime nos

No. of prime factors = $x + y + z$

(55) $13^2 \times 7^5 \times 3^8 = 2 + 5 + 8 = 15 \rightarrow$ No. of prime factors.

(56) $13^2 \times 7^5 \times 15^8 = 13^2 \times 7^5 \times 3^8 \times 5^8$
 $= 2 + 5 + 8 + 8 = 23 \rightarrow$ No. of prime factors.

$$\textcircled{\#} \sqrt{ax \sqrt{ax \sqrt{ax} \dots \infty}}$$

$$\text{Ans} = a$$

$$\textcircled{\#} \sqrt{ax \sqrt{ax \sqrt{ax} \dots n}}$$

$$\text{Ans} = \boxed{a^{\frac{2^n - 1}{2^n}}}$$

$$\textcircled{57} \sqrt{8x \sqrt{8x \sqrt{8x} \dots 7^{\text{th}} \text{ term}}}$$

$$8^{\frac{2^7 - 1}{2^7}} = 8^{\frac{127}{128}}$$

$$\textcircled{\#} \left(z \sqrt{ \left(y \sqrt{ \left(x \sqrt{ a^m } \right)^n } \right)^o } \right)^p$$

$$\text{Ans} = \boxed{\frac{m \times n \times o \times p}{x \times y \times z} a}$$

$$\textcircled{58} \sqrt[3]{ \left(\sqrt{5^4} \right)^6 } \times \sqrt{ \left(\sqrt{5^8} \right)^3 }$$

$$\Rightarrow 5^{\frac{4 \times 6}{2 \times 3}} \times 5^{\frac{8 \times 3}{6 \times 2}}$$

$$\Rightarrow 5^4 \times 5^2$$

$$\Rightarrow 5^6$$

GoCareer.in

#

$$\sqrt{a + \sqrt{a + \sqrt{a + \dots}}} \infty$$

$$= \frac{1 + \sqrt{1 + 4a}}{2}$$

अगर a के दो factors के बीच का diff 1 हो तो बड़ा factor Ans होगा।

#

$$\sqrt{a - \sqrt{a - \sqrt{a - \dots}}} \infty$$

$$= \frac{-1 + \sqrt{1 + 4a}}{2}$$

छोटे वाला factor Ans होगा।

59

$$x = \sqrt{7 + \sqrt{7 + \sqrt{7 + \dots}}} \infty$$

$$x = \frac{1 + \sqrt{29}}{2} \quad \underline{\text{Ans}}$$

$$\text{Range} = \frac{1 + \sqrt{25}}{2} \qquad \frac{1 + \sqrt{36}}{2}$$

$$= 3 \qquad = 3.5$$

$$\underline{3 < x < 3.5} \quad \underline{\text{Ans}}$$

60

$$\sqrt{12 + \sqrt{12 + \sqrt{12 + \dots}}} \dots \infty$$

3 4

$$\text{Ans} = 4.$$

61

$$x = \sqrt{8 - \sqrt{8 - \sqrt{8 - \dots}}} \infty$$

$$x = \frac{-1 + \sqrt{33}}{2}$$

$$2 < x < 2.5$$

GoCareer.in

62 $x = \sqrt{2 \times \sqrt[3]{4 \times \sqrt{2 \times \sqrt[3]{4 \times \sqrt{2 \times \sqrt[3]{4 \times \dots}}}}}} \dots \infty$

square
 $x^2 = 2 \times \sqrt[3]{4x}$

cube

$x^6 = 8 \times 4x$

$x^5 = 32$

GoCareer.in

$x^5 = 2^5$

$x = 2$ Ans

CLASS

37

Pardeep Chhokker

7206446517.

63 Factor of $(x^{29} - x^{26} - x^{23} + 1) = ?$

A) $(x-1)$ but not $(x+1)$

B) $(x+1)$ but not $(x-1)$

C) both

D) Neither $(x+1)$ nor $(x-1)$

$x+1=0$

$x=-1$

Put $x=-1$

$\Rightarrow 0$

$x-1=0$

$x=1$

Put $x=1$

$\Rightarrow 0$

$(x+1) \neq (x-1)$ both are factors

64 If $(x-2)$ is a factor of $(x^2 + kx + 4)$. Then $k = ?$

$x-2=0$

$x=2$

$\Rightarrow 4 + 2k + 4 = 0$

$2k = -8$

$k = -4$

65 If $(x+1)$ and $(x-1)$ are factors of $(ax^3 + bx^2 + 3x + 5)$. Find a and b .

$x-1=0$

$x=1$

$\Rightarrow a + b = -8$

$x+1=0$

$x=-1$

$\Rightarrow -a + b = -2$

$a = -3$

$b = -5$

(66) $\frac{x^2 - 7x + 15}{x - 3}$ find R

$x = 3 \Rightarrow 9 - 21 + 15 \Rightarrow 3$ Ans

(67) $\frac{x^{11} + 1}{x + 1} \Rightarrow x + 1 = 0$
 $x = -1$

$\cancel{x} + \cancel{x} \Rightarrow 0 = R$

GoCareer.in

(68) $\frac{x^{40} + 3}{x^4 + 1} \Rightarrow x^4 + 1 = 0$
 $x^4 = -1$

$(x^4)^{10} + 3 \Rightarrow (-1)^{10} + 3 \Rightarrow 4 = R.$

(69) $\frac{x^{51} + 51}{x + 1} \Rightarrow x = -1$
 $(-1)^{51} + 51 \Rightarrow 50 = R$

(70) $\frac{x^{51} + a}{x + 1}$, R = 50. find a

$x + 1 = 0 \Rightarrow (-1)^{51} + a = 50$

$x = -1$
 $-1 + a = 50$

$a = 51$

(71) $a^4 + a^2b^2 + b^4 = 8$ $ab = ?$

$a^2 + b^2 + ab = 4$

$a^2 + b^2 = 4 - ab$

Squaring

$a^4 + b^4 + 2a^2b^2 = 16 + a^2b^2 - 8ab$

$8 - a^2b^2 + 2a^2b^2 = 16 + a^2b^2 - 8ab$

$ab = 1$

$(a+b)^2 = a^2 + b^2 + 2ab$

$a^4 + b^4 = 8 - a^2b^2$

72) If $x^2 + 2 = 2x$
 $x^4 - x^3 + x^2 + 2 = ?$

$x^2 + 2 = 2x$

squaring

$x^4 + 4 + 4x^2 = 4x^2$

$x^4 = -4$

Now $x^2 + 2 = 2x$

$x^2 = 2x - 2$

$\frac{x^2}{2} = (x - 1)$

$\therefore -4 - x^3 + x^2 + 2$

$\Rightarrow -x^3 + x^2 - 2$

$\Rightarrow -x^2(x - 1) - 2$

Now $-x^2 \left(\frac{x^2}{2} \right) - 2$

$\Rightarrow \frac{-x^4}{2} - 2$

$\frac{4}{2} - 2$

$\Rightarrow 2 - 2 = 0$ Ans.

73) $x^4 + y^4 = 19$

$x + y = 1$

$x^2y^2 - 2xy = ?$

$x^2 + y^2 + 2xy = 1$

$x^2 + y^2 = 1 - 2xy$
square again

$\Rightarrow x^4 + y^4 + 2x^2y^2 = 1 + 4x^2y^2 - 4xy$

$\Rightarrow 19 - 2x^2y^2 - 1 = -4xy$

$\Rightarrow 18 - 2x^2y^2 + 4xy$

$\Rightarrow 9 - x^2y^2 + 2xy = 0$

$\Rightarrow -x^2y^2 + 2xy = -9$

$\Rightarrow x^2y^2 - 2xy = 9$ Ans

1) $a^4 + a^2b^2 + b^4 = 12$

$\Rightarrow -4 = -8ab$

$ab = \frac{1}{2}$

$a^2 + ab + b^2 = 4$

$ab = ?$

$a^2 + b^2 = 4 - ab$

square

$a^4 + b^4 + 2a^2b^2 = 16 + a^2b^2 - 8ab$

$12 - a^2b^2 + 2a^2b^2 = 16 + a^2b^2 - 8ab$

or $a^4 + a^2b^2 + b^4 = 12$

$$a^4 + a^2b^2 + b^4 + a^2b^2 - a^2b^2 = 12$$

$$a^4 + 2a^2b^2 + b^4 - a^2b^2 = 12$$

$$(a^2 + b^2)^2 - (ab)^2 = 12$$

$$(a^2 + b^2 - ab)(a^2 + b^2 + ab) = 12$$

$$(4 - ab - ab)(4) = 12$$

$$(4 - 2ab)(4) = 12$$

$$16 - 8ab = 12$$

$$\boxed{ab = \frac{1}{2}}$$

Pardeep Chhokker
7206446517

75 $x = a^2 + b^2$ | $\frac{a^4 + b^4}{a^2 - ab\sqrt{2} + b^2} = ?$

$y = ab\sqrt{2}$

$$x = a^2 + b^2$$

$$y = ab\sqrt{2}$$

$$x^2 = a^4 + b^4 + \underline{2a^2b^2}$$

$$y^2 = 2a^2b^2$$

$$x^2 = a^4 + b^4 + y^2$$

$$\therefore x^2 - y^2 = a^4 + b^4$$

$$\therefore \frac{(x+y)(\cancel{x-y})}{\cancel{x-y}} \Rightarrow \boxed{x+y} \quad \underline{\text{Ans}}$$

76 $x + \frac{1}{x} = 13$

$$x^2 + \frac{1}{x^2} = 13^2 - 2 = 167$$

$$x + \frac{1}{x} = 3$$

$$x^2 + \frac{1}{x^2} = 7$$

$$x^4 + \frac{1}{x^4} = 47$$

$$\boxed{\begin{aligned} x + \frac{1}{x} &= a \\ x^2 + \frac{1}{x^2} &= a^2 - 2 \end{aligned}}$$

76) if $\sqrt{x} + \frac{1}{\sqrt{x}} = 1$ | $x^{40} + \frac{1}{x^{40}} = ?$

square
 $x + \frac{1}{x} = -1$
 $x^2 + \frac{1}{x^2} = (-1)^2 - 2 = -1$
 $x^4 + \frac{1}{x^4} = -1$
 $x^8 + \frac{1}{x^8} = -1$

$x^{512} + \frac{1}{x^{512}} = ?$

$\therefore x^{512} + \frac{1}{x^{512}} = -1$ Ans

$x - \frac{1}{x} = 13$

$x^2 + \frac{1}{x^2} - 2 \cdot x \cdot \frac{1}{x} = 169$

$x^2 + \frac{1}{x^2} = 169 + 2$

* $x - \frac{1}{x} = 3$

$x^2 + \frac{1}{x^2} = 11$

$x^4 + \frac{1}{x^4} = 11^2 - 2 = 119$

* $x - \frac{1}{x} = 5$

$x^2 + \frac{1}{x^2} = 27$

$x^4 + \frac{1}{x^4} = 727$

$x - \frac{1}{x} = a$ $x^2 + \frac{1}{x^2} = a^2 + 2$
--

$x + \frac{1}{x} = 1$

$x \left(x^2 + \frac{1}{x^2} \right) = (-1)x$

$x^3 + \frac{1}{x} = -x$

$x^3 + \frac{1}{x} + x = 0$

$x^3 + 1 = 0$

$x^3 = -1$

if $x + \frac{1}{x} = 1$ or $x^2 - x + 1 = 0$ $x^3 + 1 = 0$ $x^3 = -1$	$\therefore x^3 + 1 = 0$ $x^3 = -1$
--	--

$x + \frac{1}{x} = 1$

$\frac{x^2 + 1}{x} = 1$

77) if $x + \frac{1}{x} = -1$

$x \cdot (x^2 + \frac{1}{x^2}) = (-1) \cdot x$

$(x^3 + \frac{1}{x}) = -x$

$x^3 + \frac{1}{x} + x = 0$

$x^3 - 1 = 0$

$x^3 = 1$

if $x + \frac{1}{x} = -1$
 or
 $x^2 + x + 1 = 0$
 then $x^3 = 1$
 $x^3 - 1 = 0$

77) if $x^2 + x + 1 = 0$ | find $x^3 + 1 = ?$

$\therefore x^3 = 1$

$+1 = 2$ Ans.

78) if $\sqrt{x} + \frac{1}{\sqrt{x}} = 1$

$x + \frac{1}{x} = -1$

$\therefore x^3 = 1$

$(x^3)^{13} = (1)^{13}$

$x^{39} = 1$

| $x^{40} + \frac{1}{x^{40}} = ?$

$\Rightarrow x \cdot x^{39} + \frac{1}{x \cdot x^{39}}$

$\Rightarrow x + \frac{1}{x}$

$\Rightarrow -1$ Ans.

79) if $x + \frac{1}{x} = 1$ | $x^{17} + \frac{1}{x^{17}} = ?$

$x^3 = -1$

$x^{18} = 1$

$\frac{x \cdot x^{17}}{x} + \frac{1}{\frac{x \cdot x^{17}}{x}}$

$\frac{x^{18}}{x} + \frac{x}{x^{18}}$

$\frac{1}{x} + x$

$= 1$ Ans.

Q) $x + \frac{1}{x} = 1$ | $x^{16} + x^{13} = ?$ power diff 3 then Ans 0
 $x^3 = -1$ $\Rightarrow x^3 \cdot x^{13} + x^{13}$
 $\Rightarrow -x^{13} + x^{13}$

Q1) If $x + \frac{1}{x} = 1$ | $x^{97} + x^{96} + x^{95} + x^{94} + x^{93} + x^{92}$
 $x^3 = -1$
 $= 0$

$$x^3 + \frac{1}{x^3} = \left(x + \frac{1}{x}\right)^3 - 3\left(x + \frac{1}{x}\right)$$

$$x^3 - \frac{1}{x^3} = \left(x - \frac{1}{x}\right)^3 + 3\left(x - \frac{1}{x}\right)$$



Q#) if $x + \frac{1}{x} = 3, 4, 5, 6, 10$
 $x^3 + \frac{1}{x^3} = 18, 52, 110, 198, 970$

Q#) if $x - \frac{1}{x} = 10, 6, 5, 4, 3, 2$
 $x^3 - \frac{1}{x^3} = 1030, 234, 140, 76, 36, 14$

Q2) if $a - b + 5 = 0$ | $(x-a)(x-b) = 1$ | $(x-a)^3 - \frac{1}{(x-a)^3} = 1$
 $-b = -a - 5$ $m(x-a-5) = 1$ $x-a = m$
 $m(m-5) = 1$ $m^3 - \frac{1}{m^3} = ?$
 $m-5 = \frac{1}{m}$ $= 140$
 $m - \frac{1}{m} = 5$

CLASS
3B

(33) if $x^2 + x = 5$ | $(x+3)^3 + \frac{1}{(x+3)^3} = ?$

$(m-3)^2 + (m-3) = 5$

$x+3 = m$ | $x = m-3$

$m^2 + 9 - 6m + m - 3 = 5$

$\Rightarrow m^3 + \frac{1}{m^3}$

$m^2 - 5m = -1$

$\therefore m^3 + \frac{1}{m^3} = 125 - 15 = 110$

$m(m-5) = -1$

$(m-5) = -\frac{1}{m}$

$m + \frac{1}{m} = 5$

(4) if $x(x-3) = -1$ | $x^3(x^2-18) = ?$

$(x-3) = -\frac{1}{x}$

$x + \frac{1}{x} = 3$

$\therefore x^3 + \frac{1}{x^3} = 18$

$x^6 - 18x^3 = -1$

$x^3(x^3 - 18) = -1$ Ans

$x^3 \cdot x^3 + \frac{1}{x^3} \cdot x^3 = 18 \cdot x^3$

$x^6 + 1 = 18x^3$

(AS) if $x - \frac{1}{x} = 3$ | $x^7 - \frac{1}{x^7} = ?$

$x^2 + \frac{1}{x^2} = 7$

$x^7 - \frac{1}{x^7} = 119 \times 36 + 3$

$= 9 \times 6$
 $= 54$
 $+ 3$
 $= 57$
Ans

$x^4 + \frac{1}{x^4} = 119$

$x^3 - \frac{1}{x^3} = 36$

$(x^4 + \frac{1}{x^4})(x^3 - \frac{1}{x^3}) = 119 \times 36$

$x^7 - \frac{1}{x^7} - (x - \frac{1}{x}) = 119 \times 36$

86) if $x + \frac{1}{x} = 3$ | $x^7 + \frac{1}{x^7} = ?$

$$x^4 + \frac{1}{x^4} = 47$$

$$x^3 + \frac{1}{x^3} = 18$$

$$\left(x^4 + \frac{1}{x^4}\right)\left(x^3 + \frac{1}{x^3}\right) = 47 \times 18$$

$$x^7 + \frac{1}{x^7} + \left(x + \frac{1}{x}\right) = 47 \times 18$$

$$x^7 + \frac{1}{x^7} = 47 \times 18 - 3$$

$$8 \times 7 = 56$$

-3

3 - unit digit 3

वाला Ans होगा ।

87) $x + \frac{1}{x} = 4$ | $x^5 + \frac{1}{x^5} = ?$

$$x^2 + \frac{1}{x^2} = 14$$

$$x^3 + \frac{1}{x^3} = 52$$

$$\left(x^2 + \frac{1}{x^2}\right)\left(x^3 + \frac{1}{x^3}\right) = 14 \times 52$$

$$\left(x^5 + \frac{1}{x^5}\right) = 14 \times 52 - 4$$

88) $x + \frac{1}{x} = 5$ | $x^5 + \frac{1}{x^5} = ?$

$$x^5 + \frac{1}{x^5} = 23 \times 110 - 5 \quad \text{Ans.}$$

⊕

$$\text{if } x + \frac{1}{x} = \sqrt{3}$$

$$\text{Then } x^3 + \frac{1}{x^3} = 0$$

$$x^6 + 1 = 0$$

$$x^6 = -1$$

89) if $x + \frac{1}{x} = \sqrt{3}$

$$x^2 + \frac{1}{x^2} = 1$$

OR

$$x^4 \cdot x^{96} + \frac{1}{x^4 \cdot x^{96}}$$

$$(x^6)^{16} = (-1)^{16} = 1$$

$$\therefore x^4 + \frac{1}{x^4}$$

QW: if $x + \frac{1}{x} = \sqrt{3}$

$$x^2 + \frac{1}{x^2} = 1$$

$$x^4 + \frac{1}{x^4} = -1 \quad \underline{\underline{\text{Ans}}}$$

$$x^{100} + \frac{1}{x^{100}} = ?$$

$$\frac{x^2 \cdot x^{100}}{x^2} + \frac{1 \cdot x^2}{x^{100} \cdot x^2}$$

$$\frac{x^{102}}{x^2} + \frac{x^2}{x^{102}}$$

$$(x^6)^{17} = (-1)^{17} = -1$$

$$\therefore x^{102} = -1$$

$$\therefore -\frac{1}{x^2} - x^2$$

$$-\left(\frac{1}{x^2} + x^2\right)$$

$$\Rightarrow -1 \quad \underline{\underline{\text{Ans}}}$$

90) if $x + \frac{1}{x} = \sqrt{3}$

$$x^3 + \frac{1}{x^3} = 0$$

$$x^{33} + \frac{1}{x^{33}} = ?$$

$$x^3 \cdot x^{30} + \frac{1}{x^3 \cdot x^{30}}$$

$$-x^3 - \frac{1}{x^3}$$

$$\Rightarrow -\left(x^3 + \frac{1}{x^3}\right)$$

$$= 0 \quad \underline{\underline{\text{Ans}}}$$

91) if $x + \frac{1}{x} = \sqrt{3}$

$$x^6 = -1$$

$$x^{93} + x^{91} + x^{87} + x^{85} + x^{83} + x^{89}$$

power diff 6

$$x^{16} + x^{10}$$

$$x^6 \cdot x^{10} + x^{10}$$

$$-x^{16} + x^{10}$$

$$= 0$$

$$= 0 \quad \underline{\underline{\text{Ans}}}$$

(92) if $a^2 + a + 1 = 0$ | then $a^5 + a^4 + 1 = ?$
 $a^3 = 1$ | $a^2 \cdot a^3 + a \cdot a^3 + 1$
 $= a^2 + a + 1$
 $= 0$ Ans.

① if $\begin{cases} x + \frac{1}{x} = 1 \\ x^2 - x + 1 = 0 \end{cases}$ then $x^3 = -1$

② if $\begin{cases} x + \frac{1}{x} = -1 \\ x^2 + x + 1 = 0 \end{cases}$ then $x^3 = 1$

③ if $\begin{cases} x + \frac{1}{x} = \sqrt{3} \\ x^2 - \sqrt{3}x + 1 = 0 \end{cases}$ then $x^6 = -1$

(93) $x^2 + \frac{1}{x^2} = 13$ | $x + \frac{1}{x} = ?$

$$x^2 + \frac{1}{x^2} + 2x \times \frac{1}{x} = 13 + 2$$

$$\left(x + \frac{1}{x}\right)^2 = 13 + 2$$

$$x + \frac{1}{x} = \sqrt{15}$$

if $x^2 + \frac{1}{x^2} = a$
then $x + \frac{1}{x} = \sqrt{a+2}$

if $x^2 + \frac{1}{x^2} = a$
then $x - \frac{1}{x} = \sqrt{a-2}$

94) $x^4 + \frac{1}{x^4} = 38$

$x^2 + \frac{1}{x^2} = \sqrt{38+2} = 8$

$x - \frac{1}{x} = \sqrt{8-2} = \sqrt{6}$

$x + \frac{1}{x} = \sqrt{8+2} = \sqrt{10}$

By
Pardeep Chhokker
7206446517

95) $x^4 + \frac{1}{x^4} = 322$

$x^2 + \frac{1}{x^2} = \sqrt{322+2} = 18$

$x + \frac{1}{x} = \sqrt{18+2} = \sqrt{20}$

$x - \frac{1}{x} = \sqrt{18-2} = 4$

96) $x + \frac{1}{x} = 3$ | $x^2 - \frac{1}{x^2} = ?$

$x^2 + \frac{1}{x^2} = 7$

$x^4 + \frac{1}{x^4} = 47$

$x^2 - \frac{1}{x^2} = \sqrt{47-2} = \sqrt{45} = 3\sqrt{5}$

OR $x^2 - \frac{1}{x^2}$
 $\Rightarrow (x + \frac{1}{x})(x - \frac{1}{x})$
 $x^2 + \frac{1}{x^2} = 7$
 $\therefore x - \frac{1}{x} = \sqrt{7-3} = \sqrt{4}$

$\Rightarrow 3\sqrt{5}$ Ans

97) $x + \frac{1}{x} = 4$

$x^2 + \frac{1}{x^2} = 14$

$x^4 + \frac{1}{x^4} = 194$

$x^2 - \frac{1}{x^2} = \sqrt{194-2}$
 $= 8\sqrt{3}$

$x^4 - \frac{1}{x^4} = ?$

$(x^2)^2 - (\frac{1}{x^2})^2$

$(x^2 + \frac{1}{x^2})(x^2 - \frac{1}{x^2})$

$14 \times 8\sqrt{3}$

$112\sqrt{3}$ Ans

(98) if $x + \frac{1}{x} = 3$ | $x - \frac{1}{x} = ?$

$$x^2 + \frac{1}{x^2} = 7$$

$$x - \frac{1}{x} = \sqrt{5}$$

GoCareer.in

(99) if $x - \frac{1}{x} = 1$ | $x = ?$

$$\sqrt{x} = ?$$

$$x^2 + \frac{1}{x^2} = 3$$

$$x + \frac{1}{x} = \sqrt{5}$$

$$x - \frac{1}{x} = 1$$

$$x + \frac{1}{x} = \sqrt{5}$$

$$2x = \sqrt{5} + 1$$

$$x = \frac{\sqrt{5} + 1}{2} \quad \underline{\text{Ans}}$$



$$\sqrt{x} = \sqrt{\frac{\sqrt{5} + 1}{2}} \quad \underline{\text{Ans}}$$

(100) $x^4 + \frac{1}{x^4} = 23$ | $x^3 - \frac{1}{x^3} = ?$

$$x^2 + \frac{1}{x^2} = 5$$

$$x - \frac{1}{x} = \sqrt{3}$$

$$x^3 - \frac{1}{x^3} = \left(x - \frac{1}{x}\right)^3 + 3\left(x - \frac{1}{x}\right)$$

$$\Rightarrow 3\sqrt{3} + 3\sqrt{3}$$

$$\Rightarrow 6\sqrt{3} \quad \underline{\text{Ans}}$$

(101) $x^4 + \frac{1}{x^4} = 322$ | $x^3 + \frac{1}{x^3} = ?$

$$x^2 + \frac{1}{x^2} = 18$$

$$x + \frac{1}{x} = \sqrt{20}$$

$$x^3 + \frac{1}{x^3} = \left(x + \frac{1}{x}\right)^3 - 3\left(x + \frac{1}{x}\right)$$

$$\Rightarrow 20\sqrt{20} - 3\sqrt{20}$$

$$\Rightarrow 17\sqrt{20} \quad \underline{\text{Ans}}$$

if $x^2 + y^2 + z^2 = 0$
then $x + y + z = 0$

(102) $(a-2)^2 + (b-5)^2 + (c+1)^2 = 0$ | $\sqrt{a+b+c} = ?$

$a-2=0$ | $b-5=0$ | $c+1=0$
 $a=2$ | $b=5$ | $c=-1$

$\sqrt{a+b+c} = \sqrt{2+5-1} = \sqrt{6}$ Ans

(103) $a^2 + b^2 + c^2 = 2(a-b+c) - 3$ | $a+b+c = ?$

$a^2 + b^2 + c^2 = 2a - 2b + 2c - 1 - 1 - 1$

$a^2 + 1 - 2a + b^2 + 1 + 2b + c^2 + 1 - 2c = 0$

$(a-1)^2 + (b+1)^2 + (c-1)^2 = 0$

$a-1=0$ | $b+1=0$ | $c-1=0$
 $a=1$ | $b=-1$ | $c=1$



$a+b+c = 1-1+1 = 1$ Ans

(104) $a^2 + b^2 + c^2 = 2(a+2b-2c) - 9$ | $a+b+c = ?$

$a^2 + b^2 + c^2 = 2a + 4b - 4c - 9$

$a^2 + 1 - 2a + b^2 + 4 - 4b + c^2 + 4 + 4c = -9 + 1 + 4 + 4$

$(a-1)^2 + (b-2)^2 + (c+2)^2 = 0$

$a=1$ | $b=2$ | $c=-2$

$a+b+c = 1+2-2 = 1$ Ans

$$(105) \Rightarrow \left(1 - \frac{1}{n+1}\right) + \left(1 - \frac{2}{n+1}\right) + \left(1 - \frac{3}{n+1}\right) + \dots + \left(1 - \frac{n}{n+1}\right)$$

$$\Rightarrow n - \frac{1}{n+1} - \frac{2}{n+1} - \frac{3}{n+1} - \dots - \frac{n}{n+1}$$

$$\left. \begin{aligned} &1+1+1+\dots+n \\ &= 1 \times n = n \end{aligned} \right\}$$

$$\Rightarrow n - \left[\frac{1}{n+1} + \frac{2}{n+1} + \frac{3}{n+1} + \dots + \frac{n}{n+1} \right]$$

$$\Rightarrow n - \left[\frac{1+2+3+\dots+n}{n+1} \right]$$

$$1+2+3+\dots+n = \frac{n(n+1)}{2}$$

$$\Rightarrow n - \frac{n(n+1)}{2(n+1)}$$

$$\Rightarrow n - \frac{n}{2} = \frac{n}{2}$$

$$(106) \frac{3}{4} \left(1 + \frac{1}{3}\right) \left(1 + \frac{2}{3}\right) \left(1 - \frac{2}{5}\right) \left(1 + \frac{6}{7}\right) \left(1 - \frac{12}{13}\right)$$

$$\frac{3}{4} \times \frac{4}{3} \times \frac{5}{3} \times \frac{3}{5} \times \frac{13}{7} \times \frac{1}{13} = \frac{1}{7}$$

$$(107) \left(1 - \frac{1}{2}\right) \left(1 - \frac{1}{3}\right) \left(1 - \frac{1}{4}\right) \dots \left(1 - \frac{1}{n}\right)$$

$$\frac{1}{2} \times \frac{2}{3} \times \frac{3}{4} \times \dots \times \frac{1}{n-1} \times \frac{n-1}{n} \Rightarrow \frac{1}{n}$$

$$(108) \left(2 - \frac{1}{3}\right) \left(2 - \frac{3}{5}\right) \left(2 - \frac{5}{7}\right) \left(2 - \frac{7}{9}\right) \dots \left(2 - \frac{999}{1001}\right)$$

$$\frac{5}{3} \times \frac{7}{5} \times \frac{9}{7} \times \frac{11}{9} \times \dots \times \frac{1001}{1001} \times \frac{1003}{1001}$$

$$\Rightarrow \frac{1003}{3}$$

(109) $(1 - \frac{1}{2^2})(1 - \frac{1}{3^2})(1 - \frac{1}{4^2}) \dots (1 - \frac{1}{85^2})$
 $\Rightarrow (\frac{2^2-1}{2^2})(\frac{3^2-1}{3^2})(\frac{4^2-1}{4^2}) \dots (\frac{85^2-1}{85^2})$ $a^2-b^2 = (a+b)(a-b)$
 $\Rightarrow \frac{1 \times 3}{2 \times 2} \times \frac{2 \times 4}{3 \times 3} \times \frac{3 \times 5}{4 \times 4} \times \frac{4 \times 6}{5 \times 5} \dots \frac{84 \times 86}{85 \times 85}$
 $\Rightarrow \frac{1}{2} \times \frac{86}{85} \Rightarrow \frac{43}{85}$

(110) $\frac{1}{2} + \frac{1}{3} - \frac{1}{4} - \frac{1}{2} - \frac{1}{3} + \frac{1}{4} + \frac{1}{2} + \frac{1}{3} - \frac{1}{4} \dots 34 \text{ term}$
6 terms 6 terms
0 0
 5 complete group = 0. (upto 30 terms)
 $\Rightarrow \frac{1}{2} + \frac{1}{3} - \frac{1}{4} - \frac{1}{2}$
 $\Rightarrow \frac{1}{12}$ Ans

(111) $\frac{1}{\sqrt{3}+\sqrt{4}} + \frac{1}{\sqrt{4}+\sqrt{5}} + \dots + \frac{1}{\sqrt{99}+\sqrt{100}}$
 $\Rightarrow \frac{1}{\sqrt{4}+\sqrt{3}} + \frac{1}{\sqrt{5}+\sqrt{4}} + \dots + \frac{1}{\sqrt{100}+\sqrt{99}}$ बड़ी Term
अपे लिखते हैं
 $\Rightarrow \sqrt{4}-\sqrt{3} + \sqrt{5}-\sqrt{4} + \sqrt{6}-\sqrt{5} + \sqrt{7}-\sqrt{6} + \dots + \sqrt{100}-\sqrt{99}$
 $\Rightarrow -\sqrt{3} + \sqrt{100}$ * पहले वाला no. बच रहा है।
 $\Rightarrow 10 - \sqrt{3}$ Ans

(112) $1^2 - 2^2 + 3^2 - 4^2 + 5^2 - 6^2 + \dots + 99^2 - 100^2$
 $\Rightarrow (-1 \times 3) + (-1 \times 7) + (-1 \times 11) + \dots + (-1 \times 199)$
 $\Rightarrow -3 - 7 - 11 - 15 - \dots - 199$
 $\Rightarrow -[3 + 7 + 11 + 15 + \dots + 199]$

AP series
 $S_n = \frac{n}{2} [1^{\text{st}} \text{ term} + \text{last term}]$
 $= \frac{n}{2} [2a + (n-1)d]$

$n = 50$

$\Rightarrow S_n = -\frac{50}{2} (3 + 199)$

$= -\frac{50}{2} \times \frac{202}{2} = -5050$ Ans

(113) $\frac{3}{4} + \frac{5}{36} + \frac{7}{144} + \dots + \frac{19}{8100}$

$\frac{3}{1 \times 4} + \frac{5}{4 \times 9} + \frac{7}{9 \times 16} + \dots + \frac{19}{81 \times 100}$

$\frac{1}{1} - \frac{1}{4} + \frac{1}{4} - \frac{1}{9} + \frac{1}{9} - \frac{1}{16} + \dots + \frac{1}{81} - \frac{1}{100}$

$1 - \frac{1}{100} = \frac{99}{100}$

अगर ऊपर वाले no. diff है तो इस type से हल जायेगा ! same है तो ऊपर calculations को पढ़ सकती है- (115, 116)

(114) $\frac{1}{2} + \frac{1}{6} + \frac{1}{12} + \frac{1}{20} + \dots + \frac{1}{132}$

$\frac{1}{1 \times 2} + \frac{1}{2 \times 3} + \frac{1}{3 \times 4} + \frac{1}{4 \times 5} + \dots + \frac{1}{11 \times 12}$

$\frac{1}{1} - \frac{1}{2} + \frac{1}{2} - \frac{1}{3} + \frac{1}{3} - \frac{1}{4} + \frac{1}{4} - \frac{1}{5} + \dots + \frac{1}{11} - \frac{1}{12}$

$1 - \frac{1}{12} = \frac{11}{12}$

(115) $\frac{1}{10} + \frac{1}{40} + \frac{1}{88} + \dots + \frac{1}{598}$

$\frac{1}{2 \times 5} + \frac{1}{5 \times 8} + \frac{1}{8 \times 11} + \dots + \frac{1}{23 \times 26}$

Multiply & divide by 3.

$\frac{1}{3} \left[\frac{3}{10} + \frac{3}{40} + \frac{3}{88} + \dots + \frac{3}{598} \right]$

$\frac{1}{3} \left[\frac{1}{2} - \frac{1}{5} + \frac{1}{5} - \frac{1}{8} + \frac{1}{8} - \frac{1}{11} + \dots + \frac{1}{23} - \frac{1}{26} \right]$

$\frac{1}{3} \left[\frac{1}{2} - \frac{1}{26} \right] = \frac{2}{13}$ Ans

OR $\frac{1}{\text{diff b/w terms}} \left[\frac{1}{\text{first term}} - \frac{1}{\text{last term}} \right]$

$\frac{1}{3} \left(\frac{1}{2} - \frac{1}{26} \right) = \frac{2}{13}$ Ans

$$\textcircled{116} \frac{1}{5} + \frac{1}{45} + \frac{1}{117} + \dots + \frac{1}{3965}$$

$\begin{array}{ccc} \wedge & \wedge & \wedge \\ 1 \times 5 & 5 \times 9 & 9 \times 13 \\ \vdots & \vdots & \vdots \\ \wedge & \wedge & \wedge \\ 61 & 65 & \end{array}$

$$\Rightarrow \frac{1}{4} \left[1 - \frac{1}{65} \right]$$

$$\Rightarrow \frac{1}{4} \times \frac{64}{65} = \frac{16}{65} \quad \underline{\underline{\text{Ans}}}$$

Pardeep Chhoker
7206446517

$$\textcircled{117} \frac{1}{2 + \frac{1}{1 + \frac{1}{8}}}$$

$$\Rightarrow \frac{1}{2 + \frac{1}{\frac{9}{8}}} \Rightarrow \frac{1}{2 + \frac{8}{9}} \Rightarrow \frac{1}{\frac{26}{9}} \Rightarrow \frac{9}{26} \quad \text{Ans}$$

$$\textcircled{118} \frac{1}{3 + \frac{1}{1 + \frac{1}{2 + \frac{1}{4}}}}$$

$$\Rightarrow \frac{1}{3 + \frac{1}{1 + \frac{4}{4}}} \Rightarrow \frac{1}{3 + \frac{1}{1 + \frac{4}{9}}} \Rightarrow \frac{1}{3 + \frac{1}{\frac{13}{9}}}$$

$$\Rightarrow \frac{1}{3 + \frac{9}{13}} \Rightarrow \frac{1}{\frac{48}{13}} \Rightarrow \frac{13}{48} \quad \underline{\underline{\text{Ans}}}$$

$$\textcircled{119} \frac{2}{2 + \frac{2}{3 + \frac{2}{3 + \frac{2}{3}}}} \times 0.39 \Rightarrow \frac{2}{2 + \frac{2}{3 + \frac{2}{\frac{11}{3}}}} \times 0.39$$

$$\Rightarrow \frac{2}{2 + \frac{2}{3 + \frac{6}{11}}} \times 0.39 \Rightarrow \frac{2}{2 + \frac{2}{\frac{39}{11}}} \times 0.39$$

$$\Rightarrow \frac{2}{2 + \frac{2 \times 39}{39 + 11}} \times 0.39 \Rightarrow \frac{2}{2 + \frac{11}{50}} \Rightarrow \frac{2}{\frac{100+11}{50}} \Rightarrow \frac{100}{111} \quad \underline{\underline{\text{Ans}}}$$

(120) $\frac{1}{a + \frac{1}{b + \frac{1}{c + \frac{1}{d}}}} = \frac{17}{60} \quad (a+b+c+d) = ?$

$\Rightarrow \frac{1}{\frac{60}{17}} \Rightarrow \frac{1}{3 + \frac{9}{17}} \Rightarrow \frac{1}{3 + \frac{1}{\frac{17}{9}}}$

$\Rightarrow \frac{1}{3 + \frac{1}{1 + \frac{8}{9}}} \Rightarrow \frac{1}{3 + \frac{1}{1 + \frac{1}{\frac{9}{8}}}}$

$\Rightarrow \frac{1}{3 + \frac{1}{1 + \frac{1}{1 + \frac{1}{8}}}} \Rightarrow 3 + 1 + 1 + 8 = 13 \quad \underline{\underline{\text{Ans}}}$

$\begin{array}{c} \diagdown \quad \diagup \\ a \quad b \quad c \quad d \\ \diagup \quad \diagdown \quad \diagup \quad \diagdown \end{array}$

(121) $\frac{1}{a + \frac{1}{b + \frac{1}{c}}} = \frac{9}{26}$

$\Rightarrow \frac{1}{\frac{26}{9}} \Rightarrow \frac{1}{2 + \frac{8}{9}} \Rightarrow \frac{1}{2 + \frac{1}{\frac{9}{8}}} \Rightarrow \frac{1}{2 + \frac{1}{1 + \frac{1}{8}}}$

$\begin{array}{c} \diagdown \quad \diagup \\ a \quad b \quad c \\ \diagup \quad \diagdown \end{array}$

$a = 2$
 $b = 1$
 $c = 8$



अगर यो
चे पु व
जाता तो

$\frac{1}{\frac{8}{3}}$
 $c = \left(\frac{8}{3}\right)$ होत

(122) $(x+y-z-1)^2 + (z+x-y-2)^2 + (z+y-x-4)^2 = 0 \mid x+y+z=?$

$$\begin{array}{l|l|l} x+y-z-1=0 & & \\ x+y-z=1 & z+x-y=2 & z+y-x=4 \end{array}$$

Add

$x+y+z = 7$ Ans

(123) $5x^2 + 4xy + y^2 + 2x + 1 = 0 \mid$ Find x, y .

$$x^2 + 2x + 1 + 4x^2 + y^2 + 4xy = 0$$

$$(x+1)^2 + (2x+y)^2 = 0$$

$$x+1=0$$

$$x = -1$$

$$2x+y=0$$

$$-2+y=0$$

$$y = 2$$

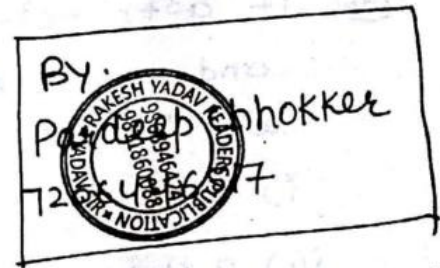

CLASS
40

GoCareer.in

(24) if $a = 999$
 $b = 997$
 $c = 995$

$$a^2 + b^2 + c^2 - ab - bc - ca = ?$$

$$a^2 + b^2 + c^2 - ab - bc - ca = \frac{1}{2} [(a-b)^2 + (b-c)^2 + (c-a)^2]$$

$$\frac{1}{2} [(2)^2 + (2)^2 + (-4)^2]$$

$$\frac{1}{2} \times 24 = 12 \text{ Ans}$$

(25) If $a = 99$
 $b = 97$
 $c = 95$

$$a^3 + b^3 + c^3 - 3abc = \frac{1}{2} (a+b+c) [(a-b)^2 + (b-c)^2 + (c-a)^2]$$

$$a^3 + b^3 + c^3 - 3abc = \frac{1}{2} \times 291 [4 + 4 + 16]$$

$$= \frac{1}{2} \times 291 \times 24 = 291 \times 12 \text{ Ans} = 3492$$

$$a^3 + b^3 + c^3 - 3abc = (a+b+c)(a^2 + b^2 + c^2 - ab - bc - ca)$$

$$a^3 + b^3 + c^3 - 3abc = 0 \text{ if } \begin{cases} \textcircled{1} a+b+c = 0 \\ \therefore a \neq b \neq c \\ \textcircled{2} a^2 + b^2 + c^2 - ab - bc - ca = 0 \\ \therefore a = b = c \end{cases}$$

126) if $a^3 + b^3 + c^3 - 3abc = 0$

and $a+b+c \neq 0$

w/c is true

i) $a > b > c$ ii) $b < a > c$

iii) $a < b < c$ iv) $a = b = c$

127) if $a^3 + b^3 + c^3 = 3abc$
and $a+b+c \neq 0$, $a, b, c \in \mathbb{N}$

find $a+b+c$

A) 2 B) 4 C) 6 D) 8

$$a = b = c$$

$$2 \quad 2 \quad 2$$

128) $\left(\frac{a+b}{c} + \frac{b+c}{a} + \frac{c+a}{b}\right) \left(\frac{a}{b+c} + \frac{b}{c+a} + \frac{c}{a+b}\right) = ?$

if $a^2 + b^2 + c^2 = ab + bc + ca$

$\therefore a = b = c$

put $a = b = c = 1$

$$3 \times \frac{3}{2} = 9 \quad \underline{\underline{\text{Ans}}}$$

$$\begin{array}{l} \text{if } a+b+c=0 \\ \text{then } a^3+b^3+c^3=3abc \end{array}$$

$$\begin{array}{l} \text{⊕ if } a+b-c=0 \\ a^3+b^3-c^3 = -3abc \end{array} \Rightarrow \begin{array}{l} a+b+(-c)=0 \\ a^3+b^3+(-c)^3 = 3ab(-c) \\ = -3abc \end{array}$$

$$\begin{array}{l} \text{129) if } a^2+b^2=c^2 \\ a^2+b^2+(-c^2)=0 \\ x+y+z=0 \\ x^3+y^3+z^3=3xyz \\ a^6+b^6-c^6 = 3 \times a^2 \times b^2 \times (-c^2) \\ = -3a^2b^2c^2 \end{array}$$

$$\begin{array}{l} \frac{a^6+b^6-c^6}{a^2b^2c^2} \\ \Rightarrow \frac{-3a^2b^2c^2}{a^2b^2c^2} \\ \Rightarrow -3 \quad \underline{\text{Ans}} \end{array}$$

$$\text{130) A) } a^3+b^3+c^3=3abc$$

$$\text{B) } a+b+c=3abc$$

$$\text{C) } (a+b-c)^3+27abc=0$$

$$\text{D) } (a+b+c)^3-27abc=0$$

$$a^{\frac{1}{3}}+b^{\frac{1}{3}}=c^{\frac{1}{3}}$$

$$a^{\frac{1}{3}}+b^{\frac{1}{3}}+(-c^{\frac{1}{3}})=0$$

$$x+y+z=0$$

$$\therefore x^3+y^3+z^3=3xyz$$

$$a+b-c=3a^{\frac{1}{3}}b^{\frac{1}{3}}(-c^{\frac{1}{3}})$$

cube

$$(a+b-c)^3 = -27abc$$

$$(a+b-c)^3 + 27abc = 0 \quad \underline{\text{Ans}}$$

GoCareer.in

131

$$a = 1 \cdot 21$$

$$b = 2 \cdot 23$$

$$c = 3 \cdot 44$$

$$a^3 + b^3 - c^3 + 3abc = ?$$

$$a + b - c = 0$$

$$\therefore a^3 + b^3 - c^3 + 3abc = 0$$

132

$$a = 1 \cdot 21$$

$$b = 2 \cdot 23$$

$$c = -3 \cdot 44$$

$$a^3 + b^3 + c^3 + 3abc = ?$$

$$a + b + c = 0$$

$$\therefore a^3 + b^3 + c^3 = -3abc$$

$$\therefore -3abc + 3abc = 0$$

133

$$\frac{(x^2 - y^2)^3 + (y^2 - z^2)^3 + (z^2 - x^2)^3}{(x - y)^3 + (y - z)^3 + (z - x)^3} = ?$$

$$\begin{matrix} (x^2 - y^2)^3 & + & (y^2 - z^2)^3 & + & (z^2 - x^2)^3 \\ a & & b & & c \end{matrix}$$

$$a = x^2 - y^2$$

$$b = y^2 - z^2$$

$$c = z^2 - x^2$$

$$a + b + c = 0$$

$$\therefore (x^2 - y^2)^3 + (y^2 - z^2)^3 + (z^2 - x^2)^3$$

$$= 3(x^2 - y^2)(y^2 - z^2)(z^2 - x^2)$$

$$= 3(x - y)(x + y)(y - z)(y + z)(z - x)(z + x)$$

Now, $\frac{(x - y)^3 + (y - z)^3 + (z - x)^3}{a \quad b \quad c}$

$$\therefore a + b + c = 0$$

$$\therefore (x - y)^3 + (y - z)^3 + (z - x)^3 = 3(x - y)(y - z)(z - x)$$

$$\Rightarrow \frac{3(x - y)(x + y)(y - z)(y + z)(z - x)(z + x)}{3(x - y)(y - z)(z - x)}$$

$$\Rightarrow (x + y)(y + z)(z + x)$$

Ans

(134) if $x+y+z = 2s$ | $\frac{(s-x)^3 + (s-y)^3 + 3(s-x)(s-y)z}{a \quad b \quad 3 \quad a \quad b \quad (a+b)} = ?$

$z = 2s - x - y$

$z = \frac{s-x}{a} + \frac{s-y}{b} \Rightarrow (s-x + s-y)^3$

$\Rightarrow (2s - x - y)^3$

$\Rightarrow z^3$ Ans

$(a+b)^3 = a^3 + b^3 + 3ab(a+b)$

(OP) $a+b+c = 0$
 $(s-x) + (s-y) + (-z) = 0$

$a^3 + b^3 + c^3 - 3abc = 0$

$(s-x)^3 + (s-y)^3 - z^3 - 3(s-x)(s-y)(-z) = 0$

$2s - x - y - z$

$(s-x)^3 + (s-y)^3 + 3(s-x)(s-y)z = z^3$

$2s - (x+y+z)$

$= 2s$

(OP) put $s = 0$

$x+y+z = 0$

$-x^3 - y^3 + 3xyz = ?$

Pardeep Chhokker
7206446517

$x^3 + y^3 + z^3 - 3xyz = 0$

$-x^3 - y^3 + 3xyz = z^3$ Ans

(135)

$a = 25$

$b = 27$

$c = 24$

$\frac{a^3 + b^3 + c^3 - 3abc}{(a-b)^2 + (b-c)^2 + (c-a)^2} = ?$

$\Rightarrow \frac{\frac{1}{2}(a+b+c) [(a-b)^2 + (b-c)^2 + (c-a)^2]}{(a-b)^2 + (b-c)^2 + (c-a)^2}$

$\Rightarrow \frac{1}{2}(a+b+c) \Rightarrow \frac{1}{2}(25+27+24)$

$\Rightarrow \frac{1}{2} \times 76 \Rightarrow 38$ Ans

$$\& \frac{a^3+b^3+c^3-3abc}{a^2+b^2+c^2-ab-bc-ca} = \frac{(a+b+c)(a^2+b^2+c^2-ab-bc-ca)}{(a^2+b^2+c^2-ab-bc-ca)}$$

$$\Rightarrow a+b+c \Rightarrow 76 \text{ Ans.}$$

136

$$\frac{1}{x+1} + \frac{2}{x+2} + \frac{3}{x+3} + \dots + \frac{1005}{x+1005} = 1200$$

$$\frac{x}{x+1} + \frac{x}{x+2} + \dots + \frac{x}{x+1005} = ?$$

$$\Rightarrow \frac{1}{x+1} - 1 + \frac{2}{x+2} - 1 + \dots + \frac{1005}{x+1005} - 1 = 1200 - 1005$$

$$\Rightarrow \frac{-x}{x+1} + \frac{-x}{x+2} + \dots + \frac{-x}{x+1005} = 195$$

do directly.

$$\Rightarrow \frac{x}{x+1} + \frac{x}{x+2} + \dots + \frac{x}{x+1005} = -195$$

इस type में या तो +1 अवल होगा या -1 होगा

137

$$\frac{a}{x-a} + \frac{b}{y-b} + \frac{c}{z-c} = 2$$

$$\frac{x}{x-a} + \frac{y}{y-b} + \frac{z}{z-c} = ?$$

Add +1

$$\therefore 2+3 = 5 \text{ Ans}$$



138

$$\frac{a^2-bc}{a^2+bc} + \frac{b^2-ac}{b^2+ac} + \frac{c^2-ab}{c^2+ab} = 1$$

$$\frac{a^2}{a^2+bc} + \frac{b^2}{b^2+ca} + \frac{c^2}{c^2+ab} =$$

$$\frac{a^2-bc}{a^2+bc} + 1$$

$$= 1+3 = 4$$

$$\Rightarrow \frac{2a^2}{a^2+bc}$$

$$\Rightarrow \frac{4}{2} \Rightarrow 2 \text{ Ans}$$

$$\begin{array}{l|l}
 \textcircled{139} \quad x+y+z = 10 & x^3+y^3+z^3-3xyz = ? \\
 x^2+y^2+z^2 = 30 & \Rightarrow (x+y+z)(x^2+y^2+z^2 - (xy+yz+zx)) \\
 x+y+z = 10 & \Rightarrow 10(30-35) = -50 \text{ Ans.} \\
 \text{square} & \\
 x^2+y^2+z^2+2(xy+yz+zx) = 100 & \\
 \therefore xy+yz+zx = 100-30 = \frac{70}{2} = 35 &
 \end{array}$$

$$\begin{array}{l|l}
 \textcircled{140} \quad x+y+z = 15 & x^3+y^3+z^3-3xyz = ? \\
 x^2+y^2+z^2 = 83 & \rightarrow 15(83-71) \\
 xy+yz+zx = \frac{225-83}{2} & \rightarrow 15 \times 12 \\
 = 71 & \rightarrow 180 \text{ Ans}
 \end{array}$$

$$\begin{array}{l|l|l}
 \textcircled{141} \quad a+b+c = 6 & x^3+y^3+z^3-3xyz = ? & a^3+b^3+c^3 = 40 \\
 a^2+b^2+c^2 = 16 & \Rightarrow 40-3abc = 6(16-10) & 'abc = ? \\
 ab+bc+ca = \frac{36-16}{2} & \Rightarrow 7abc = 4 & \\
 = 10 & \Rightarrow abc = \frac{4}{7} &
 \end{array}$$

$$\begin{array}{l|l}
 \textcircled{142} \quad x+y+z = 8 & x^3+y^3+z^3-3xyz = ? \\
 xy+yz+zx = 24 & \Rightarrow 8(16-24) \\
 x^2+y^2+z^2 = 16 & = 8(-8) = -64 \text{ Ans}
 \end{array}$$

BY Pooja Chhokker

2014 517

150 if $x - \frac{1}{x} = 1$ | $x^2 - \sqrt{x} + 1$

$$x^2 + \frac{1}{x^2} = 3$$

$$x + \frac{1}{x} = \sqrt{5}$$

$$\frac{x - \frac{1}{x} = 1}{x = \frac{\sqrt{5} + 1}{2}}$$

$$\sqrt{x} = \sqrt{\frac{\sqrt{5} + 1}{2}}$$

$$\frac{1}{\sqrt{x}} = \frac{\sqrt{2}}{\sqrt{\sqrt{5} + 1}}$$

divide by x

$$\rightarrow \frac{1}{x + \frac{1}{x} - \frac{1}{\sqrt{x}}}$$

$$\rightarrow \frac{1}{\sqrt{5} - \frac{1}{\sqrt{x}}}$$

$$\rightarrow \frac{1}{\sqrt{5} - \frac{\sqrt{2}}{\sqrt{\sqrt{5} + 1}}} \quad \underline{\underline{\text{Ans}}}$$

151 if $x(3 - \frac{2}{x}) = \frac{3}{x}$ | $x^2 + \frac{1}{x^2} = ?$

$$3x - 2 = \frac{3}{x}$$

$$3x - \frac{3}{x} = 2$$

Divide by 3

$$\frac{3x}{3} - \frac{3}{3x} = \frac{2}{3}$$

$$x - \frac{1}{x} = \frac{2}{3}$$

$$x^2 + \frac{1}{x^2} = \frac{4}{9} + 2 = \frac{22}{9} \quad \underline{\underline{\text{Ans.}}}$$

152 $3a + \frac{1}{5a} = 6$ | $25a^2 + \frac{1}{9a^2} = ?$

multiply by $\frac{5}{3}$ (to get coeff of a-5)

$$\frac{5}{3} \times 3a + \frac{1}{5a} \times \frac{5}{3} = 6 \times \frac{5}{3}$$

$$5a + \frac{1}{3a} = 10$$

$$25a^2 + \frac{1}{9a^2} + 2 \times 5a \times \frac{1}{3a} = 100$$

$$\begin{aligned} 25a^2 + \frac{1}{9a^2} &= 100 - \frac{10}{3} \\ &= \frac{290}{3} \quad \underline{\underline{\text{Ans}}} \end{aligned}$$

153 $a + \frac{1}{64a} = \frac{12}{2}$ | $64a^2 + \frac{1}{64a^2} = ?$ $64a^2 = (8a)^2$

Multiply by 8 (to get coeff of $a=8$)

$$8a + \frac{1}{8a} = 12$$

$$64a^2 + \frac{1}{64a^2} + 2 \cdot 8a \cdot \frac{1}{8a} = 144$$

Pardeep Chhokker
7206446517

$$64a^2 + \frac{1}{64a^2} = 144 - 2 = 142 \quad \underline{\text{Ans}}$$

154 $4b^2 + \frac{1}{b^2} = 2$ | $8b^3 + \frac{1}{b^3} = ?$

$$(2b)^2 + \left(\frac{1}{b}\right)^2 = 2$$

$$(2b)^2 + \left(\frac{1}{b}\right)^2 + 2 \times 2b \times \frac{1}{b} = 2 + 4$$

$a^3 + b^3$

$$a^3 + \frac{1}{a^3} = \left(a + \frac{1}{a}\right)^3 - 3a \cdot \frac{1}{a} \left(a + \frac{1}{a}\right)$$

$$(2b + \frac{1}{b})^2 = 6$$

$$2b + \frac{1}{b} = \sqrt{6}$$

$$8b^3 + \frac{1}{b^3} = \left(2b + \frac{1}{b}\right)^3 - 3 \times 2b \times \frac{1}{b} \left(2b + \frac{1}{b}\right)$$

$$\Rightarrow 6\sqrt{6} - 6\sqrt{6} \Rightarrow 0 \quad \underline{\text{Ans}}$$

155 $3x + \frac{1}{2x} = 5$ | $8x^3 + \frac{1}{27x^3} = ?$

$$3x \times \frac{2}{3} + \frac{1}{2x \times \frac{3}{2}} = \frac{5 \times 2}{3}$$

$$2x + \frac{1}{3x} = \frac{10}{3}$$

$$8x^3 + \frac{1}{27x^3} = \left(2x + \frac{1}{3x}\right)^3 - 3 \times 2x \times \frac{1}{3x} \left(2x + \frac{1}{3x}\right)$$

$$= \frac{1000}{27} - 2x \times \frac{10}{3}$$

$$= \frac{1000}{27} - \frac{20}{3}$$

$$= \frac{1000 - 180}{27} = \frac{820}{27} \quad \underline{\text{Ans}}$$

(156) $(2x - \frac{3}{x}) = 5$

$4x^2 - \frac{9}{x^2} = ?$

$4x^2 + \frac{9}{x^2} - 2 \times 2x \times \frac{3}{x} = 25$

$\Rightarrow (2x)^2 - (\frac{3}{x})^2$

$\Rightarrow (2x - \frac{3}{x})(2x + \frac{3}{x})$

$4x^2 + \frac{9}{x^2} = 37$

$\rightarrow 5 \times 7$

$(2x + \frac{3}{x})^2 - 2 \cdot 2x \cdot \frac{3}{x} = 37$

$\rightarrow 35$ Ans

$(2x + \frac{3}{x})^2 = 37 + 12 = 49$

(OP) put $x=3$

$36 - 1 = 35$ Ans

$(2x + \frac{3}{x}) = 7$

if $a + \frac{1}{a} = 2$
 $\Rightarrow a = 1$

(157) if $a + \frac{1}{a} = 2$

$a^{112} - \frac{1}{a^3} = ?$

$1 - 1 = 0$ Ans.

(158) $m + \frac{1}{m-2} = 4$

i) $(m-2)^{10} + \frac{1}{(m-2)^{10}} = ?$

$(m-2) + \frac{1}{m-2} = 4 - 2$

ii) $m^3 + m^2 + m - 1 = ?$

$27 + 9 + 3 - 1 = 38$ Ans

$(m-2) + \frac{1}{(m-2)} = 2$

i) $1 + 1 = 2$ Ans

$\therefore m - 2 = 1$

$m = 3$

(159) $m + \frac{1}{m+2} = 0$

i) $(m+2)^{10} + \frac{1}{(m+2)^{10}} = ?$

$(m+2) + \frac{1}{(m+2)} = 0 + 2$

$1 + 1 = 2$ Ans

$\therefore m + 2 = 1$

ii) $m^3 + m^2 + m - 1 = ?$

$1 + 1 - 1 - 1 = -2$ Ans

$m = -1$

$$\begin{aligned} \text{if } x + \frac{1}{x} &= -2 \\ \Rightarrow x &= -1 \end{aligned}$$

$$\begin{aligned} \text{(60) if } m + \frac{1}{m-2} &= 0 & | & \quad m^5 + m^4 + m^3 + m^2 + m + 1 = ? \\ (m-2) + \frac{1}{(m-2)} &= 0 - 2 = -2 & \Rightarrow & \quad 1 + 1 + 1 + 1 + 1 + 1 \\ & & \Rightarrow & \quad 6 \text{ Ans} \end{aligned}$$

$$\therefore m - 2 = -1$$

$$m = 1$$

componendo - dividendo

Applicable only when fraction is equivalent to something.
Doesn't applicable on single fraction.

$$\frac{a}{b} = \frac{5}{1}$$

$$\frac{a}{b}$$

$$\frac{a+b}{a-b} = \frac{5+1}{5-1}$$

$$\frac{a+b}{a-b} = \frac{6}{4} = \frac{3}{2}$$

Apply again

$$\frac{a+b+a-b}{a+b-a+b} = \frac{3+2}{3-2}$$

$$\frac{2a}{2b} = \frac{5}{1}$$

$$\frac{a}{b} = \frac{5}{1} \quad (\text{same form obtained})$$

\therefore अगर पहले से apply किया हुआ है तो बस fraction निरवो और दूसरी side apply करें।

(161) $\frac{2x-y}{x+2y} = \frac{1}{2}$

$4x-2y = x+2y$

$3x = 4y$

$\frac{3x}{y} = \frac{4}{1}$

$\frac{3x+y}{3x-y} = \frac{5}{3}$

$\therefore \frac{3x-y}{3x+y} = \frac{3}{5}$

CLASS
42

Pankaj Yadav Reader's Publication
726517

(162) $a+b = 1$
 $c+d = 1$
 $a-b = \frac{d}{c}$
 $c^2-d^2 = ?$

$\frac{a+b}{a-b} = \frac{1}{d/c}$

$\frac{a+b}{a-b} = \frac{c}{d}$

$\frac{a}{b} = \frac{c+d}{c-d}$

$\frac{a}{b} = \frac{1}{c-d}$

$c-d = \frac{b}{a}$

$c^2-d^2 = (c+d)(c-d)$
 $= (1)\left(\frac{b}{a}\right)$
 $= \left(\frac{b}{a}\right)$ Ans

(163) $x = \frac{2ab}{b^2+1}$, $b > 1$

$\frac{\sqrt{a+x} - \sqrt{a-x}}{\sqrt{a+x} + \sqrt{a-x}} = ?$

$\frac{x}{a} = \frac{2ab}{(b^2+1)a}$

$\frac{x}{a} = \frac{2b}{b^2+1}$

$\frac{a}{x} = \frac{b^2+1}{2b}$

$\frac{a+x}{a-x} = \frac{b^2+1+2b}{b^2+1-2b}$

$\frac{a+x}{a-x} = \frac{(b+1)^2}{(b-1)^2}$

$\Rightarrow \frac{\sqrt{a+x}}{\sqrt{a-x}} = \frac{b+1}{b-1}$

$\Rightarrow \frac{\sqrt{a+x} + \sqrt{a-x}}{\sqrt{a+x} - \sqrt{a-x}} = \frac{b}{1}$

$\Rightarrow \frac{\sqrt{a+x} - \sqrt{a-x}}{\sqrt{a+x} + \sqrt{a-x}} = \frac{1}{b}$ Ans

can also be solved by rationalising

(164) $\frac{x^3+3x}{3x^2+1} = \frac{189}{61}$ find value of x

$$\frac{x^3+3x+3x^2+1}{x^3+3x-3x^2-1} = \frac{189+61}{189-61}$$

$$(a+b)^3 = a^3 + 3a^2b + 3ab^2 + b^3$$

$$(a-b)^3 = a^3 - 3a^2b + 3ab^2 - b^3$$

$$\frac{(x+1)^3}{(x-1)^3} = \frac{250}{128} = \frac{125}{64}$$

$$\frac{(x+1)^3}{(x-1)^3} = \frac{(5)^3}{(4)^3}$$

cube root

$$\frac{x+1}{x-1} = \frac{5}{4}$$

$$\frac{x}{1} = \frac{5+4}{5-4}$$

$$x = 9 \quad \underline{\text{Ans}}$$



(165) $(a+b) : \sqrt{ab} = 4:1, a > b \mid a:b = ?$

$$\frac{a+b}{\sqrt{ab} \times 2} = \frac{4}{1 \times 2}$$

$$\frac{a+b}{2\sqrt{ab}} = \frac{2}{1}$$

$$\frac{a+b+2\sqrt{ab}}{a+b-2\sqrt{ab}} = \frac{2+1}{2-1}$$

$$\frac{(\sqrt{a}+\sqrt{b})^2}{(\sqrt{a}-\sqrt{b})^2} = \frac{3}{1}$$

$$\Rightarrow \frac{\sqrt{a}+\sqrt{b}}{\sqrt{a}-\sqrt{b}} = \frac{\sqrt{3}}{1}$$

$$\Rightarrow \frac{\sqrt{a}}{\sqrt{b}} = \frac{\sqrt{3}+1}{\sqrt{3}-1}$$

$$\Rightarrow \frac{a}{b} = \frac{4+2\sqrt{3}}{4-2\sqrt{3}} = \frac{2(2+\sqrt{3})}{2(2-\sqrt{3})}$$

$$\Rightarrow \frac{a}{b} = \frac{2+\sqrt{3}}{2-\sqrt{3}} \quad \underline{\text{Ans}}$$

(OP) $a+b = 4$

$$a + \frac{1}{a} = 4$$

$$a^2 - 4a + 1 = 0$$

$$a = \frac{-b \pm \sqrt{b^2 - 4ac}}{2a}$$

$$= \frac{4 \pm \sqrt{16 - 4 \times 1 \times 1}}{2 \times 1}$$

$$\sqrt{ab} = 1$$

$$ab = 1$$

$$b = \frac{1}{a}$$

$$\Rightarrow \frac{4 \pm 2\sqrt{3}}{2}$$

$$a = 2 + \sqrt{3}, 2 - \sqrt{3}$$

$$b = \frac{1}{a} = \frac{2-2\sqrt{3}}{2+2\sqrt{3}}, \frac{2+\sqrt{3}}{2-\sqrt{3}}$$

$$\therefore a > b$$

$$a = 2 + \sqrt{3}$$

$$b = 2 - \sqrt{3}$$

$$\frac{a}{b} = \frac{2+\sqrt{3}}{2-\sqrt{3}}$$

$$(166) \quad x = \frac{\sqrt{m+3n} + \sqrt{m-3n}}{\sqrt{m+3n} - \sqrt{m-3n}}$$

$$3nx^2 + 3n = ?$$

$$\frac{x+1}{x-1} = \frac{\sqrt{m+3n}}{\sqrt{m-3n}}$$

$$\frac{(x^2+1)+2x}{(x^2+1)-2x} = \frac{m+3n}{m-3n}$$

$$\frac{(x+1)^2}{(x-1)^2} = \frac{m+3n}{m-3n}$$

$$\Rightarrow \frac{x^2+1}{2x} = \frac{m}{3n}$$

$$\Rightarrow 3nx^2 + 3n = 2mx \quad \underline{\underline{\text{Ans}}}$$

$$\begin{aligned} (2+\sqrt{3})^2 &= 4+3+2 \cdot 2\sqrt{3} \\ &= 7+4\sqrt{3} \\ &\quad \begin{array}{c} \swarrow \quad \searrow \\ a^2+b^2 \quad 2ab \end{array} \end{aligned}$$

$$(167) \quad x = 7+4\sqrt{3} \quad \text{find } \sqrt{x}$$

$$\begin{array}{c} \swarrow \quad \searrow \\ 4+3 \quad 2 \cdot 2\sqrt{3} \\ (2)^2 \quad (\sqrt{3})^2 \quad a \cdot b \end{array}$$

$$x = (2+\sqrt{3})^2$$

$$\sqrt{x} = 2+\sqrt{3} \quad \underline{\underline{\text{Ans}}}$$

$$(168) \quad x = 13-4\sqrt{3} \quad \text{find } \sqrt{x}$$

$$\begin{array}{c} \swarrow \quad \searrow \\ 12+1 \quad 2 \cdot 2\sqrt{3} \\ \quad \quad \quad a \cdot b \\ \quad \quad \quad \swarrow \quad \searrow \\ \quad \quad \quad 2\sqrt{3} \times 1 \quad 12 \times 1 \end{array}$$

$$x = (2\sqrt{3}-1)^2$$

$$\sqrt{x} = 2\sqrt{3}-1 \quad \underline{\underline{\text{Ans}}}$$

GOCareer.in

169 $x = 76 + 10\sqrt{3}$. find \sqrt{x}

$$= 76 + 2 \cdot 5\sqrt{3}$$

$$\begin{array}{c} \wedge \\ (5\sqrt{3})^2 + (1)^2 \\ 75 + 1 \end{array} \quad \begin{array}{c} | \\ ab \\ \wedge \\ 5\sqrt{3} \times 1 \end{array}$$

$$x = (5\sqrt{3} + 1)^2$$

$$\sqrt{x} = 5\sqrt{3} + 1 \quad \underline{\text{Ans}}$$

170 $x = 33 - 4\sqrt{35}$. find \sqrt{x}

$$= 33 - 2 \cdot 2\sqrt{35}$$

$$\begin{array}{c} \wedge \\ a^2 + b^2 \\ 28 + 5 \end{array} \quad \begin{array}{c} | \\ ab \\ \wedge \\ 2\sqrt{7} \quad \sqrt{5} \end{array}$$

$$x = (2\sqrt{7} - \sqrt{5})^2$$

$$\sqrt{x} = 2\sqrt{7} - \sqrt{5}$$

171 $x = 139 - 80\sqrt{3}$. find \sqrt{x}

$$= 139 - 2 \cdot 40\sqrt{3}$$

$$\begin{array}{c} \wedge \\ a^2 + b^2 \\ 64 + 75 \end{array} \quad \begin{array}{c} | \\ ab \\ \wedge \\ 8 \times 5\sqrt{3} \end{array}$$

$$x = (5\sqrt{3} - 8)^2$$

$$\sqrt{x} = 5\sqrt{3} - 8 \quad \underline{\text{Ans}}$$

*) बड़ा no. पहले। जिसका २० बड़ा है वह २० बड़ा है

172 $x = 52 + 30\sqrt{3}$. find \sqrt{x}

$$= 52 + 2 \cdot 15\sqrt{3}$$

$$\begin{array}{c} \wedge \\ a^2 + b^2 \\ 25 + 27 \end{array} \quad \begin{array}{c} | \\ ab \\ \wedge \\ 5 \times 3\sqrt{3} \end{array}$$

$$x = (3\sqrt{3} + 5)^2$$

$$\sqrt{x} = 3\sqrt{3} + 5$$

173 $x = 8 - 4\sqrt{3}$. find \sqrt{x}

$$= 8 - 2 \cdot 2\sqrt{3}$$

$$2\sqrt{3} = \sqrt{4 \times 3} = \sqrt{12}$$

$$x \Rightarrow 8 - 2 \cdot \sqrt{12}$$

$$\begin{array}{c} \wedge \\ a \quad b \\ \sqrt{6} \quad \sqrt{2} \end{array}$$

$$x = (\sqrt{6} - \sqrt{2})^2$$

$$\sqrt{x} = (\sqrt{6} - \sqrt{2}) \quad \underline{\text{Ans}}$$

By.
Pardeep Chhokker
7206446517

$$(174) \sqrt{-\sqrt{3} + \sqrt{3 + 8\sqrt{7+4\sqrt{3}}}}$$

$$\Rightarrow \sqrt{-\sqrt{3} + \sqrt{3 + 8(2+\sqrt{3})}}$$

$$\Rightarrow \sqrt{-\sqrt{3} + \sqrt{19 + 8\sqrt{3}}}$$

$\begin{array}{c} \wedge \qquad \qquad \qquad \wedge \\ a^2+b^2 \quad 2 \cdot 4\sqrt{3} \\ 16+3 \qquad \qquad \qquad ab \\ \qquad \qquad \qquad \wedge \\ \qquad \qquad \qquad 4\sqrt{3} \end{array}$

$$\sqrt{-\cancel{\sqrt{3}} + 4 + \cancel{\sqrt{3}}}$$

$$= 2 \quad \underline{\text{Ans}}$$

$$(175) \quad x = 38 + 5\sqrt{3} \quad \text{find } \sqrt{x}$$

$$= \frac{38 \times 2 + 2 \times 5\sqrt{3}}{2}$$

$$= \frac{76 + 2 \cdot 5\sqrt{3}}{2}$$

$$x = \frac{(5\sqrt{3} + 1)^2}{2}$$

$$\sqrt{x} = \frac{5\sqrt{3} + 1}{\sqrt{2}} \quad \underline{\text{Ans}}$$

$$(176) \quad x = 26 + 15\sqrt{3} \quad \text{find } \sqrt{x}$$

$$x = \frac{52 + 2 \cdot 15\sqrt{3}}{2}$$

$$x = \frac{(3\sqrt{3} + 5)^2}{2}$$

$$\sqrt{x} = \frac{3\sqrt{3} + 5}{\sqrt{2}}$$

GoCareer.in

CLASS
4B

Pardeep Chhoker
7206446517

(177) $x = \frac{\sqrt[3]{m+1} + \sqrt[3]{m-1}}{\sqrt[3]{m+1} - \sqrt[3]{m-1}}$

$x^3 - 3mx^2 + 3x - m = ?$

$\Rightarrow \frac{x+1}{x-1} = \frac{\sqrt[3]{m+1}}{\sqrt[3]{m-1}}$

$\Rightarrow \frac{x^3+3x}{1+3x^2} = \frac{m}{1}$

$\Rightarrow \frac{(x+1)^3}{(x-1)^3} = \frac{m+1}{m-1}$

$\Rightarrow x^3+3x = m + 3mx^2$

$\Rightarrow \frac{x^3+3x+1+3x^2}{x^3+3x-1-3x^2} = \frac{m+1}{m-1}$

$\Rightarrow x^3 - 3mx^2 + 3x - m = 0$

$\Rightarrow \frac{(x^3+3x) + (1+3x^2)}{(x^3+3x) - (1+3x^2)} = \frac{m+1}{m-1}$

(178) if $x = \frac{4ab}{a+b}$

$\frac{x+2a}{x-2a} + \frac{x+2b}{x-2b}$

divide by 2a
 $\Rightarrow \frac{x}{2a} = \frac{2b}{a+b}$

$\Rightarrow \frac{3b+a}{b-a} - \frac{3a+b}{b-a}$

$\Rightarrow \frac{x+2a}{x-2a} = \frac{2b+a+b}{2b-a-b}$

$\Rightarrow \frac{3b+a-3a-b}{b-a} \Rightarrow \frac{2(b-a)}{b-a} = 2$

$\Rightarrow \frac{x+2a}{x-2a} = \frac{3b+a}{b-a}$

(*) $x = \frac{4ab}{a+b}$ | $\frac{x+2a}{x-2a} + \frac{x+2b}{x-2b}$

Now divide by 2b

$\Rightarrow \frac{x}{2b} = \frac{2a}{a+b}$

if $2 \cdot \frac{2ab}{a+b}$ | $\frac{x+2a}{x-2a} + \frac{x+2b}{x-2b}$

$\Rightarrow \frac{x+2b}{x-2b} = \frac{3a+b}{a-b}$

$\frac{2ab}{2a} = b$

$= - \frac{3a+b}{b-a}$

$\frac{2ab}{2b} = a$

> नीचे वाली term कयनी
चाहिए ।

इसका Ans होगा 2 होगा

179) if $x = \frac{4\sqrt{15}}{\sqrt{5} + \sqrt{3}}$ | $\frac{x + \sqrt{12}}{x - \sqrt{12}} + \frac{x + \sqrt{20}}{x - \sqrt{20}}$ ⇒ यहाँ में
 componendo
 & dividendo
 देना चाहिए
 व \oplus को हट

⇒ $\frac{2 \cdot 2\sqrt{15}}{\sqrt{5} + \sqrt{3}} \Rightarrow \frac{2\sqrt{60}}{\sqrt{5} + \sqrt{3}}$ factor कला देना चाहिए ।

$\frac{\sqrt{60}}{\sqrt{12}} = \sqrt{5}$ > नीचे वाले part.
 $\frac{\sqrt{60}}{\sqrt{20}} = \sqrt{3}$ Ans = 2

180) if $x = \frac{\sqrt{3}}{2}$

$1+x = 1 + \frac{\sqrt{3}}{2}$
 $= \frac{2 + \sqrt{3}}{2}$
 $= \frac{2 \cdot 2 + 2 \cdot \sqrt{3}}{2 \cdot 2}$
 $= \frac{4 + 2\sqrt{3}}{4}$

$\sqrt{1+x} = ?$
 $\sqrt{(\sqrt{3})^2 + (1)^2} = \sqrt{3 + 1}$
 $\sqrt{4} = 2$

$\left(\frac{\sqrt{3} + 1}{2}\right)^2 = 1+x$

$\frac{\sqrt{3} + 1}{2} = \sqrt{1+x}$

if $x = \frac{\sqrt{3}}{2}$
 Then $\sqrt{1+x} = \frac{\sqrt{3} + 1}{2}$
 $\sqrt{1-x} = \frac{\sqrt{3} - 1}{2}$

GoCareer.in

181) if $x = \frac{\sqrt{3}}{2}$ | $\frac{\sqrt{1+x}}{1+\sqrt{1+x}} + \frac{\sqrt{1-x}}{1-\sqrt{1-x}} = ?$

$$\frac{\frac{\sqrt{3}+1}{2}}{1+\frac{\sqrt{3}+1}{2}} + \frac{\frac{\sqrt{3}-1}{2}}{1-\frac{\sqrt{3}-1}{2}}$$

$$\frac{\sqrt{3}+1}{3+\sqrt{3}} + \frac{\sqrt{3}-1}{3-\sqrt{3}}$$

$$\frac{\cancel{\sqrt{3}+1}}{\sqrt{3}(\cancel{\sqrt{3}+1})} + \frac{\cancel{\sqrt{3}-1}}{\sqrt{3}(\cancel{\sqrt{3}-1})}$$

$$\frac{1}{\sqrt{3}} + \frac{1}{\sqrt{3}} = \frac{2}{\sqrt{3}}$$

GoCareer.in

182) if $x = \frac{\sqrt{3}}{2}$ | $\frac{1+x}{1+\sqrt{1+x}} + \frac{1-x}{1-\sqrt{1-x}} = ?$

$$\frac{1+\frac{\sqrt{3}}{2}}{1+\frac{\sqrt{3}+1}{2}} + \frac{1-\frac{\sqrt{3}}{2}}{1-\frac{\sqrt{3}-1}{2}}$$

$$\Rightarrow \frac{2+\sqrt{3}}{3+\sqrt{3}} + \frac{2-\sqrt{3}}{3-\sqrt{3}}$$

$$\Rightarrow \frac{6-2\sqrt{3}+3\sqrt{3}-3+6-3\sqrt{3}+2\sqrt{3}-3}{(3+\sqrt{3})(3-\sqrt{3})}$$

$$\Rightarrow \frac{12-6}{6} = \frac{6}{6} = 1 \quad \underline{\underline{\text{Ans}}}$$

183) if $x = \frac{2\sqrt{10}}{7}$ | $\frac{\sqrt{1+x}}{\sqrt{1+x}-\sqrt{1-x}} = ?$

$$1+x = \frac{7+2\sqrt{10}}{7}$$

$$= \left(\frac{\sqrt{5}+\sqrt{2}}{\sqrt{7}}\right)^2$$

$$\sqrt{1+x} = \frac{\sqrt{5}+\sqrt{2}}{\sqrt{7}}$$

$$\frac{\sqrt{5}+\sqrt{2} + \sqrt{5}-\sqrt{2}}{\sqrt{5}+\sqrt{2} - \sqrt{5}+\sqrt{2}} = \frac{2\sqrt{5}}{2\sqrt{2}} = \frac{\sqrt{5}}{\sqrt{2}} \quad \underline{\underline{\text{Ans}}}$$

$$\textcircled{\text{OR}} \frac{\sqrt{1+x} + \sqrt{1-x}}{\sqrt{1+x} - \sqrt{1-x}} = \frac{m}{1}$$

$$\frac{\sqrt{1+x}}{\sqrt{1-x}} = \frac{m+1}{m-1}$$

$$\frac{\sqrt{5} + \sqrt{2}}{\sqrt{5} - \sqrt{2}} = \frac{m+1}{m-1}$$

$$\frac{\sqrt{5}}{\sqrt{2}} = \frac{m}{1}$$



$\textcircled{\text{OR}}$ By rationalization

$$\frac{\sqrt{1+x} + \sqrt{1-x}}{\sqrt{1+x} - \sqrt{1-x}}$$

Rationalize

$$\frac{1+x+1-x+2\sqrt{1-x^2}}{1+x-1-x} = \frac{2+2\sqrt{1-x^2}}{2x}$$

$$= \frac{2+2 \times \frac{3}{7}}{2 \times 2\sqrt{10}} = \frac{5}{\sqrt{10}} = \frac{\sqrt{5}}{\sqrt{2}} \quad \underline{\underline{\text{Ans}}}$$

$$\begin{aligned} x &= \frac{2\sqrt{10}}{7} \\ 1-x^2 &= 1 - \frac{40}{49} \\ &= \frac{9}{49} \\ \sqrt{1-x^2} &= \frac{3}{7} \end{aligned}$$



$$\textcircled{5} \quad x = \frac{\sqrt{3}}{2} \quad \left| \quad \sqrt{1+x} - \sqrt{1-x} \right.$$

$$\frac{\sqrt{3}+1}{2} - \frac{\sqrt{3}-1}{2}$$

$$\frac{\sqrt{3}+1 - \sqrt{3}+1}{2} = \frac{2}{2} = 1$$



Geometric Progression (GP)

$$a_1, a_2, a_3$$

$$4, 8, 16, 32, 64$$

$$\frac{4}{8} = \frac{1}{2}, \quad \frac{8}{16} = \frac{1}{2}, \quad \frac{16}{32} = \frac{1}{2}, \quad \frac{32}{64} = \frac{1}{2}$$

ratio of two terms will be same.

$$\text{common ratio } (r) = \frac{a_2}{a_1}$$

$$T_n = ar^{n-1}$$

$$S_n = \frac{a(r^n - 1)}{r - 1}, \quad r > 1$$

$$S_n = \frac{a(1 - r^n)}{(1 - r)}, \quad r < 1$$

$$S_{\infty} = \frac{a}{1 - r}, \quad r < 1$$

$\textcircled{25}$ If a ball is thrown from a height of 360 m. It bounces $\frac{2}{3}$ times of its every last bounce. Calculate the total distance covered by the ball till it stops.

$$600 + 400 + \dots \infty$$

$$S_{\infty} = \frac{600}{1 - \frac{2}{3}} = 1800 \text{ m}$$



$$360 + 240 = 600 \text{ (1st bounce)}$$

$$240 + 160 = 400 \text{ (2nd bounce)}$$

$$160 + 160 \times \frac{2}{3} \text{ like this}$$

186) if a ball is thrown from a height of 900 m. It bounces back to $\frac{4}{5}$ of its previous height. The ball bounces $\frac{4}{5}$ times of its previous height. find the total distance covered by the ball till it stops.

$$S_{\infty} = 900 + 720 + \dots \infty$$

$$S_{\infty} = \frac{900}{1 - \frac{4}{5}} = 4500 \text{ m.}$$

187) The sides of a Δ are 6, 8, 10 cm. if a Δ is formed by joining the mid points of all the sides of that Δ and in the same process infinite no. of Δ s are formed. find the sum of area of infinite Δ s.

$$24 + 6 + \dots \infty$$

$$r = \frac{6}{24} = \frac{1}{4}$$

$$S_{\infty} = \frac{24}{1 - \frac{1}{4}} = \frac{24 \times 4}{3} = 32 \text{ cm}^2$$

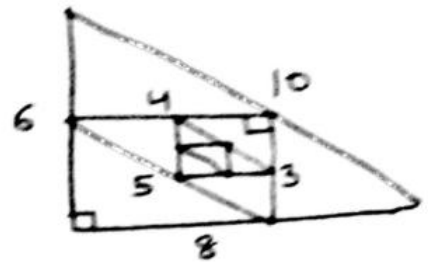

$$\frac{1}{2} \times 6 \times 8 = 24$$

$$\frac{1}{2} \times 3 \times 4 = 6$$

188) The side of a square is 8 cm. A square is formed by joining the mid points of all sides and so on infinite no. of squares are formed.

$$64 + 32 + \dots$$

$$S_{\infty} = \frac{64}{1 - \frac{1}{2}} = 128 \text{ cm}^2$$

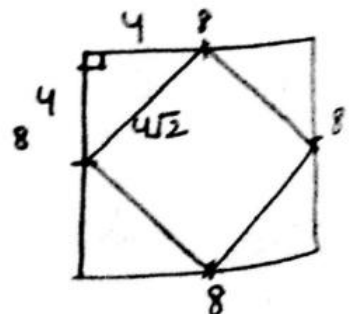

(189) (25) $1 + \frac{1}{2} + \frac{1}{4} + \frac{1}{8} + \frac{1}{16} + \frac{1}{32} + \dots \infty$

$$S_{\infty} = \frac{1}{1 - \frac{1}{2}} = 2$$

$$(25)^2 = 625$$

GoCareer.in

ARITHMETICAL PROGRESSIONS

4, 8, 12, 16, 20, ...

common diff (d) = $a_2 - a_1$

$$T_n = a + (n-1)d$$

$$S_n = \frac{n}{2} [\text{1st term} + \text{last term}]$$

$$S_n = \frac{n}{2} [2a + (n-1)d]$$

$$n = \frac{\text{last term} - \text{first term}}{d} + 1$$

(190) find the sum of all the +3 digit no w/c are exactly divisible by 12

$$108 + 120 + 132 + \dots + 996$$

$$n = \frac{996 - 108}{12} + 1$$

$$\Rightarrow \frac{888}{12} + 1 \Rightarrow 74 + 1 \Rightarrow 75$$

$$S_n = \frac{75}{2} [108 + 996] \Rightarrow \frac{75}{2} \times 1104$$

$$\Rightarrow 75 \times 552 \text{ Ans}$$

(191) find the total no. of terms b/w 100 and 300 w/c are exactly divisible by 4 or 6

Number of terms divisible by 4

$$n_4 = \frac{296 - 104}{4} + 1 = 49$$

No. of terms divisible by 6

102, 108, --- 294

$$n_6 = \frac{294 - 102}{6} + 1 = 33$$

No. of terms divisible by 12

108, 120, --- 288

$$n_{12} = \frac{288 - 108}{12} + 1 = 16$$

∴ No. of terms b/w 100 and 300 that are divisible by 4 or 6 $\Rightarrow 49 + 33 - 16 = 66$

No. of terms divide by 4 and 6 = 66 Ans

(LCM of 4 & 6 = 12)

CLASS
44

Pardeep Chhokker
7206446517

(192) if the sum of 1st 11 terms of an A.P is equal to the sum of 1st 19 terms of that AP. find the sum of first 30 terms of that A.P.

$$S_{11} = S_{19}$$

$$\frac{11}{2} [2a + 10d] = \frac{19}{2} [2a + 18d]$$

$$22a + 110d = 38a + 18 \times 19d$$

$$\boxed{2a = -29d}$$

$$S_{30} = \frac{30}{2} [2a + (30-1)d]$$

$$= 15 [-29d + 29d]$$

$$= 0 \quad \underline{\text{Ans}}$$

(193) Find the total no. terms b/w 100 and 300 w/c are exactly divided by 4.

$$104, 108, \dots, 296$$

$$n = \frac{296 - 104}{4} + 1 = 49$$

(194) If the Avg of n numbers is a . If 2 is added in 1st term, 4 is added in 2nd term, 8 is added in 3rd term and in the same way he added in every term. Find the new Avg.

$$\begin{array}{ccccccc} - & , & - & , & - & , & - & , & - & , & - & , & - \\ +2 & & +4 & & +8 & & & & & & & & \end{array}$$

$$\text{Avg} = \frac{\text{sum}}{n} = a$$

$$\text{sum} = na$$

$$S_n = \frac{2(2^n - 1)}{2 - 1} = 2(2^n - 1)$$

$$\text{New Avg} = \frac{na + 2(2^n - 1)}{n}$$

$$= a + \frac{2(2^n - 1)}{n} \quad \underline{\underline{\text{Ans}}}$$

(195) $999 \frac{57}{99} \times 99$

$$\left[999 + \frac{57}{99} \right] \times 99$$

$$\begin{array}{r} 99000 \\ - 42 \\ \hline \end{array}$$

$$98958$$

Ans.

57 की जगह
99 मान लें
 $999 + 1 = 1000$
 $1000 \times 99 = 99000$
 $99 - 57 = 42$

$$9 \frac{5}{9} \times 9$$

$$\left(9 + \frac{5}{9} \right) \times 9$$

अगर 5 की जगह 9 मान लें

$$10 \times 9 = 90$$

$$90 - 4 = 86 \quad \underline{\underline{\text{Ans}}}$$

(195) $9 \frac{9998}{9999} \times 9999$

$(9 + \frac{9998}{9999}) \times 9999$

$$\begin{array}{r} 99990 \\ -1 \\ \hline 99989 \end{array}$$

9998 की जगह 9999 मान लो। बाद में 1 घटा दो

(196) $\frac{1}{5} + 99999 \frac{44}{45} \times 9$

इस Pattern में $\frac{44}{45} >$ यहाँ 1 का diff. होगा.

$\frac{44}{45} \times 9$ → ये यहाँ 5 पे कट रहा है तो subtracting में $\frac{1}{5}$ Add होगा.

इसका Ans. → जितने 9 एवं में हैं वो लिख लो और जितने 9 fraction से पहले हैं उतनी zero लिख लो।

∴ 900000 Ans.

(197) $\frac{1}{5} + 999 \frac{44}{45} \times 9$

9000 Ans

(198) $99\frac{1}{7} + 99\frac{2}{7} + 99\frac{3}{7} + \dots + 99\frac{6}{7}$

$99 + \frac{1}{7} + 99 + \frac{2}{7} + 99 + \frac{3}{7} + \dots + 99 + \frac{6}{7}$

$99 \times 6 + \frac{1}{7} + \frac{2}{7} + \dots + \frac{6}{7}$

$594 + \frac{1+2+3+\dots+6}{7}$

$594 + \frac{21}{7}$

$594 + 3 = 597 \text{ Ans}$

(199) $9\frac{1}{3} + 99\frac{1}{3} + 999\frac{1}{3} + \dots + 999999\frac{1}{3}$
 $9 + \frac{1}{3} + 99 + \frac{1}{3} + 999 + \frac{1}{3} + \dots + 999999 + \frac{1}{3}$
 $(9+99+999+9999+99999+999999) + (\frac{1}{3} + \frac{1}{3} + \frac{1}{3} + \frac{1}{3} + \frac{1}{3} + \frac{1}{3})$
 $1111104 + 2 = 1111106$ Ans

(200) $4 + 44 + 444 + \dots + 100 \text{ terms}$
 $4[1 + 11 + 111 + \dots + 100 \text{ term}]$
 $4 \times \frac{9}{9} [1 + 11 + 111 + \dots + 100 \text{ term}]$
 $\frac{4}{9} [9 + 99 + 999 + \dots + 100 \text{ term}]$
 $\frac{4}{9} [10^1 - 1 + 10^2 - 1 + 10^3 - 1 + \dots + 10^{100} - 1]$

$\frac{4}{9} \left[\frac{10(10^{100} - 1)}{10 - 1} - 100 \right]$
 \downarrow
 $9P$

By.
 Pardeep Chhokker
 7206446517

$\Rightarrow \frac{4}{9} \left[\frac{10(10^{100} - 1) - 900}{9} \right]$

Number of zeros

(201) $1 \times 2 \times 3 \times 4 \times \dots \times 10$
 3 appears how much time.
 $\frac{10}{3} = 3$ ← जब तक divide करो तब तक 3 मै छोटा ना हो
 $\frac{3}{3} = 1$
4 times

(202) $1 \times 2 \times 3 \times 4 \times \dots \times 1200$
 5 appears how many times
 $\frac{1200}{5} = 240$
 $\frac{240}{5} = 48$
 $\frac{48}{5} = 9$
 $\frac{9}{5} = 1$ an

203) $192 \times 65 \times 1250 \times 750 \times 55 \times 37 \times 39 \times 36$. Find no. of zeros
 $2^6 \times 5^1 \times 5^4 \times 2^1 \times 5^3 \times 2^1 \times 5^1$ 2^2

$2 \rightarrow 10$ times
 $5 \rightarrow 9$ times

(2×5) pair = 9 pairs.
 so. no. of zeros is 9 in this multiplication.

Find no. of zeros
 $\sqrt{2 \times 5}$
 $= 10$
 0 appears when 2 and 5 is multiplied

204) $1 \times 3 \times 5 \times 7 \times 9 \times \dots \times 87$
 no. of zeros = 0 (2 and 5 multiply में)

205) $1 \times 3 \times 5 \times 7 \times 9 \times \dots \times 87 \times 256$
 $5 \rightarrow 11$ times
 $2 \rightarrow 8$ times

(2×5) pair $\rightarrow 8$ pairs
 so. no. of zeros = 8

5 - 1	75 \rightarrow 2
15 - 1	85 \rightarrow 1
25 - 2	<u>11</u>
35 - 1	
45 - 1	
55 - 1	
65 - 1	

206) $5 \times 10 \times 15 \times \dots \times 45$
 $5 \rightarrow 10$ times
 $2 \rightarrow 7$ times

No. of zeros = 7 Ans

207) $1 \times 2 \times 3 \times \dots \times 100 \div 5 = 20$
 $5 \rightarrow 24$ times
 no. of zeros = 24

$\frac{20}{5} = \frac{4}{24}$

$2 \rightarrow 5$ से more than ही होंगे।
 हर समी term में है so, 5 देखेंगे क्या।

(208) $1 \times 2 \times \dots \times \frac{1000}{5} = 200$

$\frac{200}{5} = 40$

$\frac{40}{5} = 8$

$\frac{8}{5} = \frac{1}{249}$

No of zeros
= 249

(209) $513 \times 514 \times \dots \times 1048$

$1 \times 2 \times 3 \times 4 \times \dots \times \frac{512}{5} \times 513 \times 514 \times \dots \times \frac{1048}{5} = 209$

$\frac{512}{5} = 102$

$\frac{102}{5} = 20$

$\frac{20}{5} = \frac{4}{126}$

$\frac{209}{5} = 41$

$\frac{41}{5} = 8$

$\frac{8}{5} = \frac{1}{259}$

No of 5 $\rightarrow 259 - 126 = 133$

No of zeros = 133 Ans

(210) $10 \times 20 \times 30 \times \dots \times 1000$

$\rightarrow 10 \times 1 \times 10 \times 2 \times 10 \times 3 \times \dots \times 10 \times 100$

$\rightarrow 10^{100} \times 1 \times 2 \times 3 \times 4 \times \dots \times \frac{100}{5} = 20$

$100 + 24$

$\frac{20}{5} = \frac{4}{24}$

= 124 \rightarrow No of zeros.

(21) $1^{20} \times 2^{20} \times 3^{20} \times \dots \times 38^{20}$

$1 \times 2 \times 3 \times 4 \times \dots \times 38 = \frac{38!}{5} = 7$

$\frac{7}{5} = \frac{1}{8} \text{ times} \Rightarrow 5$

5	→	20
10	→	20
15	→	20
20	→	20
25	→	40
30	→	20
35	→	20
		<hr/>
		160

$5^{20} \rightarrow 5 \rightarrow 20 \text{ times}$

No. of zero = 168

2 is very frequent
sa bahut 5 denko

(212) $1^2 \times 2^3 \times 3^4 \times 4^5 \times \dots \times 28^{29}$

$5^6 \rightarrow 6$

5 appears 106 times

$10^{11} \rightarrow 11$

No. of zero = 106

$15^{16} \rightarrow 16$

$20^{21} \rightarrow 21$

$25^{26} \rightarrow \frac{52}{106}$



(213) $a = 1^3, b = 2^4, c = 3^5, \dots, z = 26^{28}$

$a \times b \times c \times \dots \times z$

$1^3 \times 2^4 \times 3^5 \times 4^6 \times \dots \times 26^{28}$

$5^7 \rightarrow 7$

No. of zeros = 112

$10^{12} \rightarrow 12$

$15^{17} \rightarrow 17$

$20^{22} \rightarrow 22$

$25^{27} \rightarrow \frac{54}{112}$

(214) $x(x+a)(x+2a)(x+3a) + ?$

A) a^4

C) $16a^3$

B) $2a^2$

D) $9a^4$

put $x=1, a=1$

$1 \times 2 \times 3 \times 4 = 24 + \textcircled{1}$
 \downarrow
 a^4

or

$x=1, a=2$

$1 \times 3 \times 5 \times 7 = 105 + \textcircled{16}$
 \downarrow
 a^4

अगर एक और option में a^2 ही तो $a=1$ दोनों option (a^4, a^2) में। result देगा। So. option देख कर value put करें।

इस case में $a=2$ रख दी।

What should be _____ so that it becomes perfect square.

it's an identity. All value must be satisfied. Place any value of x & a .

(215) If $a+b+c=0$

$\frac{1}{a^2+b^2-c^2} + \frac{1}{b^2+c^2-a^2} + \frac{1}{a^2+c^2-b^2} = ?$

$a+b = -c$

$a^2+b^2+2ab = c^2$

$a^2+b^2-c^2 = -2ab$

$\therefore \frac{1}{-2ab} + \frac{1}{-2bc} + \frac{1}{-2ac} \Rightarrow \frac{a+b+c}{-2abc} = 0$

(OR) value putting

$\frac{1}{-2} + \frac{1}{4} + \frac{1}{4} = 0$

put $a=1, b=1, c=-2$

Keep in mind while putting values - denominator में zero नहीं बनना चाहिए। ∞ ही जायेगा।



216) if $pa+qa+rp=0$ | $\frac{p^2}{p^2-qr} + \frac{q^2}{q^2-rp} + \frac{r^2}{r^2-pq}$

$pa+rp = -qr$

$pa+qa = -rp$

$qr+rp = -pq$

$\frac{p^2}{p^2+pa+rp} + \frac{q^2}{q^2+pa+rp} + \frac{r^2}{r^2+qr+rp}$

$\frac{p}{p+q+r} + \frac{q}{p+q+r} + \frac{r}{p+q+r}$

$\frac{p+q+r}{p+q+r} = \textcircled{1} \underline{\underline{\text{Ans}}}$

value putting.

$p=1$
 $q=-2$
 $r=-2$

$\frac{1}{1-4} + \frac{4}{4+2} + \frac{4}{4+2}$

$-\frac{1}{3} + \frac{4}{3} = \frac{-1+4}{3} = \frac{3}{3} = \textcircled{1} \underline{\underline{\text{Ans}}}$



इस case में दो value
 true की same रखनी है।
 दो value same रखनी है
 या true की या ne की।

217) if $\frac{x-a^2}{b+c} + \frac{x-b^2}{c+a} + \frac{x-c^2}{a+b} = 4(a+b+c)$ | find x

A) $(a+b+c)^2$ C) $(a^2+b^2+c^2-ab-bc-ca)$

B) $(a^2+b^2+c^2)$ D) $(ab+bc+ca)$

X option B → not justified

$\frac{b^2+c^2}{b+c}$ (square की बात नहीं होगा)

option A → $\frac{(a+b+c)^2 - a^2}{b+c}$

$\Rightarrow \frac{(a+b+c-a)(a+b+c+a)}{b+c} \Rightarrow 2a+b+c$

\Rightarrow similarly $(2a+b+c) + (a+2b+c) + (a+b+2c)$
 $= 4(a+b+c)$ satisfied

OR put values of a, b, c (any values)
 $a = b = c = 1$

$$\frac{x-1}{2} + \frac{x-1}{2} + \frac{x-1}{2} = 12$$

$$x = 9$$

Now check w/c option gives 9 by putting values of a, b, c

✓ option A $(a+b+c)^2 \Rightarrow (1+1+1)^2 = 9$ ✓

(218) if $x + \frac{1}{y} = 1$ and $y + \frac{1}{z} = 1$ | $z + \frac{1}{x} = ?$

$$x = 1 - \frac{1}{y}$$

$$x = \frac{y-1}{y}$$

$$\frac{1}{x} = \frac{y}{y-1}$$

$$\frac{1}{z} = \frac{1-y}{1}$$

$$z = \frac{1}{1-y}$$

$$\frac{1}{1-y} + \frac{y}{y-1}$$

$$\Rightarrow \frac{1}{1-y} - \frac{y}{1-y}$$

$$\frac{1-y}{1-y} = \textcircled{1}$$

Ans.

OR

$$x = \frac{1}{2}$$

$$y = 2$$

$$z = -1$$

$$-1 + 2 = 1 \text{ Ans}$$

(219) $\frac{a}{b} = \frac{4x^3}{5x^3}$, $\frac{b}{c} = \frac{15}{16}$

$$\frac{a}{b} = \frac{12}{15}, \quad \frac{b}{c} = \frac{15}{16}$$

$$a : b : c \\ 12 : 15 : 16$$

$$\therefore \frac{a}{c} = \frac{12}{16} \times \frac{3}{4}$$

$$\frac{a}{c} = \frac{3}{4}$$

$$\frac{c}{a} = \frac{4}{3}$$

$$\frac{27c^2 - 7a^2}{36c^2 + 18a^2} = ?$$

$$27 \frac{c^2}{a^2} - 7 \frac{a^2}{a^2}$$

$$\frac{36 \frac{c^2}{a^2} + 18 \frac{a^2}{a^2}}{36 \frac{c^2}{a^2} + 18 \frac{a^2}{a^2}}$$

$$\frac{48 - 7}{64 + 18} = \frac{41}{82} = \frac{1}{2}$$

अगर c^2 से divid करे तो fraction बनेगा।

Ans

(220) if $p \cdot q \cdot r = 1$ | $\frac{1}{1+p+q^{-1}} + \frac{1}{1+r+p^{-1}} + \frac{1}{1+q+r^{-1}}$

$\Rightarrow \frac{q}{q+pq+1} + \frac{1}{1+\frac{1}{pq}+\frac{1}{p}} + \frac{1}{1+q+pq}$

\downarrow
 $\frac{pq+1+q}{pq}$
 \downarrow
 pq

$\Rightarrow \frac{q}{q+pq+1} + \frac{pq}{pq+1+q} + \frac{1}{1+q+pq}$

$\Rightarrow \frac{q+pq+1}{1+q+pq} = \textcircled{1} \text{ Ans}$

OR

Put $p=q=r=1$

$\Rightarrow \frac{1}{3} + \frac{1}{3} + \frac{1}{3} = \frac{3}{3} = \textcircled{1} \text{ Ans}$

(221) if $\frac{a+b+c}{2} = 2s$ | $\frac{(s-a)^2 + (s-b)^2 + (s-c)^2 + s^2}{a^2+b^2+c^2} = ?$

$\frac{12}{12} = \textcircled{1} \text{ Ans.}$

(222) if $\frac{x-a^2}{b^2+c^2} + \frac{x-b^2}{c^2+a^2} + \frac{x-c^2}{b^2+a^2} = 3$ | find x

~~A) $a^2+b^2+c^2$~~

B) $(a+b+c)^2$

C) $(a^2+b^2+c^2-ab-bc-ca)$

D) $ab+bc+ca$

Put $a=b=c=1$

$\frac{x-1}{2} + \frac{x-1}{2} + \frac{x-1}{2} = 3$

$\frac{x-1+x-1+x-1}{2} = 3$

$\frac{3x-3}{2} = 3$

$x=3$

option A gives 3

223 if $xy + yz + zx = 0$ | $\frac{1}{x^2 - yz} + \frac{1}{y^2 - zx} + \frac{1}{z^2 - xy}$

224 if $\frac{a}{b+c} + \frac{b}{c+a} + \frac{c}{a+b} = 1$ | $\frac{a^2}{b+c} + \frac{b^2}{c+a} + \frac{c^2}{a+b} = ?$

$$\left(\frac{a}{b+c} + \frac{b}{c+a} + \frac{c}{a+b} \right) (a+b+c) = 1(a+b+c)$$

$$\Rightarrow \frac{a^2 + a(b+c)}{b+c} + \frac{b^2 + b(c+a)}{c+a} + \frac{c^2 + c(a+b)}{a+b} = a+b+c$$

$$\Rightarrow \frac{a^2}{b+c} + \cancel{a} + \frac{b^2}{c+a} + \cancel{b} + \frac{c^2}{a+b} + \cancel{c} = \cancel{a} + \cancel{b} + \cancel{c}$$

$$\Rightarrow \frac{a^2}{b+c} + \frac{b^2}{c+a} + \frac{c^2}{a+b} = 0 \quad \underline{\text{Ans}}$$

OP $\frac{a}{b+c} + \frac{b}{c+a} + \frac{c}{a+b} = 1$

$$\frac{1}{3} \quad \frac{1}{3} \quad \frac{1}{3}$$

$$\frac{a}{b+c} = \frac{1}{3}$$

$$\begin{aligned} b+c &= 3a \\ \therefore c+a &= 3b \\ \therefore a+b &= 3c \\ \hline 2(a+b+c) &= 3(a+b+c) \end{aligned}$$

$$\therefore a+b+c = 0$$

$$b+c = -a$$

wrong method
but Ans
जा जायेगा!

$$\frac{a^2}{b+c} + \frac{b^2}{c+a} + \frac{c^2}{a+b}$$

$$\frac{a^2}{-a} + \frac{b^2}{-b} + \frac{c^2}{-c}$$

$$-a - b - c$$

$$-(a+b+c)$$

$$= 0 \quad \underline{\text{Ans}}$$

OR (Short the ques.)

$$\frac{a}{b+c} + \frac{b}{c+a} + \frac{c}{a+b} = 1 \quad \left| \quad \frac{a^2}{b+c} + \frac{b^2}{c+a} + \frac{c^2}{a+b} = p \right.$$

$a=0$

$b=1$ ($b=0$ में एक part ∞ हो जायेगा)

$$\frac{1}{c} + c = 1$$

$$\frac{1+c^2}{c} = 1$$

$$1+c^2 = c$$

$$\frac{1}{c} + c^2$$

$$\left(\frac{1}{c} + c \right) - 1$$

$$1-1 = 0$$

225) if $\frac{b-c}{a} + \frac{a+c}{b} + \frac{a-b}{c} = 1 \quad \left| \quad a-b+c \neq 0 \right.$

$b=1$
 $c=1$

$$\therefore \frac{a+1}{1} + \frac{a-1}{1} = 1$$

$$a+1+a-1 = 1$$

$$\boxed{a = \frac{1}{2}}$$

$b=1$
 $c=1$

A) $\frac{1}{b} = \frac{1}{a} - \frac{1}{c}$

B) $\frac{1}{b} = \frac{1}{a} + \frac{1}{c}$

C) $\frac{1}{c} = \frac{1}{a} + \frac{1}{b}$

D) None of these.



GoCareer.in

226) if $a + \frac{1}{a} = -1$ | $(1-a+a^2)(1+a-a^2) = ?$

$$a^2 + a + 1 = 0$$

$$a^2 + 1 = -a$$

$$a + 1 = -a^2$$

$$a^3 = 1$$

$$-2a \times -2a^2$$

$$\Rightarrow 4a^3$$

$$\Rightarrow 4 \times 1 = 4$$

GoCareer.in



$ax^2 + bx + c$

$a = +ve$

Min. value = $\frac{4ac - b^2}{4a}$

Max. value = ∞



$ax^2 + bx + c$

$a = -ve$

Max. value = $\frac{4ac - b^2}{4a}$

Min value = $-\infty$

227) find min. value of $(x-9)(x-2)$

$x^2 - 11x + 18$

min value = $\frac{4 \times 1 \times 18 - 121}{4} = -\frac{49}{4}$



a_1, a_2, a_3, \dots are the terms of A.P series.
if $a_1 + a_5 + a_{10} + a_{15} + a_{20} + a_{24} = 225$. find the sum of
1st 24 terms of this series.

$a + a + 4d + a + 9d + a + 14d + a + 19d + a + 23d = 225$

$6a + 69d = 225$
 $(2a + 23d) = 75$

$S_{24} = \frac{24}{2} [2a + 23d] = 12 \times 75 = 900$ Ans.

$\because T_n = a + (n-1)d$

HCF of 20 & 25

$$\begin{array}{r}
 20 \overline{) 25} \quad 1 \\
 \underline{20} \\
 5 \overline{) 20} \quad 4 \\
 \underline{20} \\
 0
 \end{array}$$

HCF (last divisor)

HCF of 24 & 90

$$\begin{array}{r}
 24 \overline{) 90} \quad 3 \\
 \underline{72} \\
 18 \overline{) 24} \quad 1 \\
 \underline{18} \\
 6 \overline{) 18} \quad 3 \\
 \underline{18} \\
 0
 \end{array}$$

HCF

① finding the HCF by long division method the sequence of quotient from top to bottom is 3, 1, 3 and the last divisor is 6. find the sum of both the numbers.

sequence को bottom to top लिखना है ।

$$\begin{array}{l}
 6 \times 3 + 0 = 18 \\
 18 \times 1 + 6 = 24 \\
 24 \times 3 + 18 = 90
 \end{array}$$

OR

$$\begin{array}{r}
 24 \overline{) 90} \quad 3 \\
 \underline{-72} \\
 18 \overline{) 24} \quad 1 \\
 \underline{-18} \\
 6 \overline{) 18} \quad 3 \\
 \underline{-18} \\
 0
 \end{array}$$

$$\begin{array}{r}
 24 + 90 \\
 = 114
 \end{array}$$

② finding the HCF by long division method of two no's the sequence of quotient from top to bottom is 9, 8, 5 and the last divisor is 16. find the sum of two no's.

$$\begin{array}{l}
 16 \times 5 + 0 = 80 \\
 80 \times 8 + 16 = 656 \\
 656 \times 9 + 80 = 5984
 \end{array}$$

$$\begin{array}{r}
 5984 \\
 656 \\
 \hline
 6640 \quad \text{Ans}
 \end{array}$$

③ finding the HCF by long division method of two numbers the sequence of quotient from top to bottom is 2, 2 & 13 and the last divisor is 35. find both the numbers.

$$\begin{array}{l}
 35 \times (13) + 0 = 455 \\
 455 \times (2) + 35 = 945 \\
 945 \times (2) + 455 = 2345
 \end{array}$$

Two no's are 945 and 2345.

④ Find HCF of 72 & 90.

$$\begin{array}{r|l}
 2 & 72 \\
 \hline
 2 & 36 \\
 \hline
 2 & 18 \\
 \hline
 3 & 9 \\
 \hline
 & 3
 \end{array}$$

$$\begin{array}{r|l}
 2 & 90 \\
 \hline
 3 & 45 \\
 \hline
 3 & 15 \\
 \hline
 & 5
 \end{array}$$

HCF = $2 \times 3 \times 3 = 18$ Ans
 ↓
 common factors.

OR

72 90



diff = 18 Ans.



GoCareer.in

HCF या तो diff होगा या diff का factor.

⑤ HCF of 48, 90, 120.

pick two numbers जिनके बीच का diff सबसे कम हो.
 या तो diff HCF होगा या diff का factor.

48, 90, 120
 30

30 = 2 x 15
 3 x 10
 5 x (6) — HCF

HCF = 6

⑥ 216, 423, 1215, 1422, 2169, 2223. find HCF.

$$\frac{423}{27} \text{ (Not divide)}$$

$$27 \times$$

54 → diff.

$$1 \times 54$$

$$2 \times 27$$

$$3 \times 18$$

$$6 \times 9 \text{ — HCF}$$

HCF = 9.

⑦ There are three prime numbers, the product of 1st two no. is 1891 and the product of last two no. is 7991. find all the numbers.

$$\begin{array}{l} I \times II = 1891 \\ II \times III = 7991 \end{array} \left. \vphantom{\begin{array}{l} I \times II = 1891 \\ II \times III = 7991 \end{array}} \right] \text{HCF} = II$$

$$\begin{array}{r} 1891 \quad 7991 \\ \hline 6100 \end{array}$$

$$61 \times 100$$

HCF = 61

∴ 2nd no. = 61

1st no. = $\frac{1891}{61} = 31$

3rd no. = $\frac{7991}{61} = 131$

* 3, 5, 7

$$\begin{array}{l} 3 \times 5 = 15 \\ 5 \times 7 = 35 \end{array} \left. \vphantom{\begin{array}{l} 3 \times 5 = 15 \\ 5 \times 7 = 35 \end{array}} \right] \text{HCF} = 5$$

w/c is 2nd no.

(100 या 100 के factor से इनमें से कोई no. divide नहीं होगा)

GoCareer.in

⑧ find the largest no. of two digit w/c when divided by 211 and 396 gives same remainder.

$$\begin{array}{r} 211 \quad 396 \\ \hline \text{diff} = 185 \end{array}$$

वो no. हमेशा diff या diff का factor होगा।

⑨ find the greatest no. w/c when divided to 410, 751 and 1030 gives same remainder.

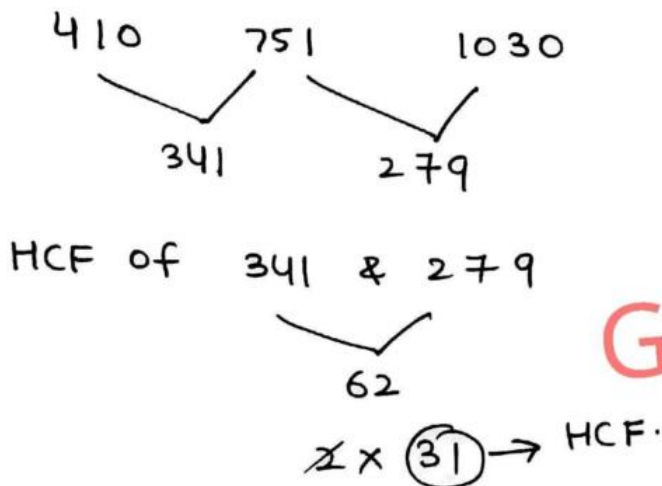
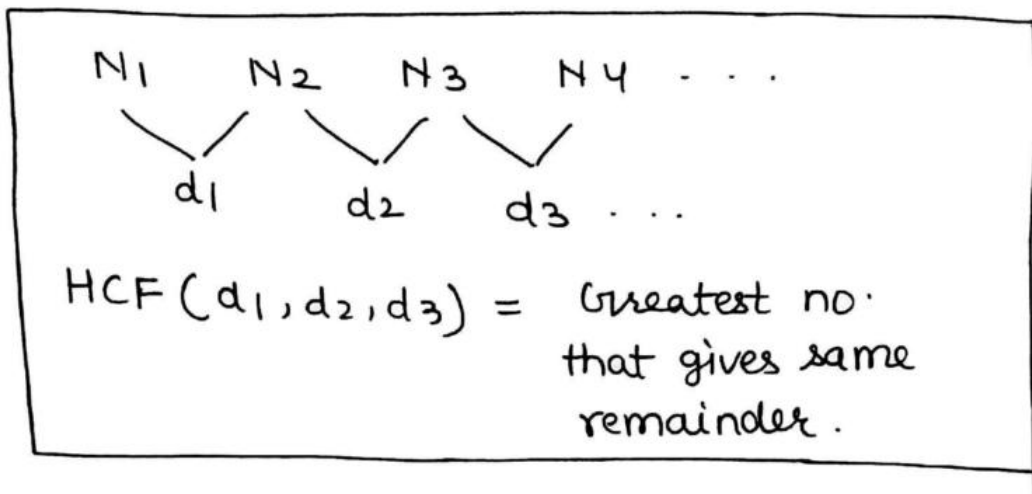

GoCareer.in

That no. is 31. Ans

⑩ A farmer has 945 cows and 2475 buffaloes. He wants to graze them in minimum no. of groups in such a way that each group has only one type of animal and also contains equal no. of animals in each group. find such minimum no. of groups.

⑪ A gardener has 44 apple trees, 66 banana trees and 110 mango trees. He wants to plant them in such a way that each row contains only one type of plant and also has equal no. of plants. find no. of minimum rows.

12) The area of three field are 288cm^2 , 408cm^2 , 552cm^2 .
Equal minimum size blocks are made in the field. If the width of each rectangular block is 4cm . find its length.

13) Find the least no. of Equal size square tiles w/c can be fitted in a rectangular field whose sides are $284\text{m} \times 248\text{m}$.

Solⁿ 10

HCF (945, 2475)

45

$$\left. \begin{array}{l} \frac{945}{45} = 21 \\ \frac{2475}{45} = 55 \end{array} \right\} \Rightarrow 76$$

By Pardeep Chhoker
7206446517

OR

$$\begin{array}{r|l} 5 & 945 \\ \hline 3 & 189 \\ \hline 3 & 63 \\ \hline 3 & 21 \\ \hline & 7 \end{array}$$

$$\begin{array}{r|l} 5 & 2475 \\ \hline 5 & 495 \\ \hline 3 & 99 \\ \hline 3 & 33 \\ \hline & 11 \end{array}$$

HCF = $5 \times 3 \times 3 = 45$

HCF के बाद जो बच गया वो group है।

$7 \times 3 + 5 \times 11 = 76$ Ans

11

A
44

B
66

M
110

HCF = 22

$\frac{44}{22} = 2$

$\frac{66}{22} = 3$

$\frac{110}{22} = 5$

$2 + 3 + 5 = 10$ rows.

12) $(288, 408, 552) - \text{HCF} = 24$ $\left\{ \begin{array}{l} 4 - \text{width} \\ 6 - \text{length} \end{array} \right.$

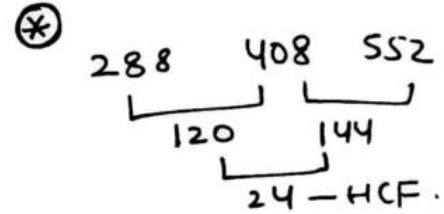
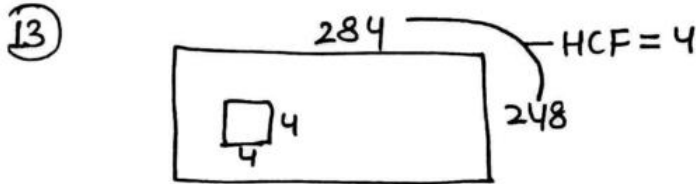

$$\text{No. of tiles} = \frac{284 \times 248}{4 \times 4} = 4402 \text{ tiles.}$$

14) 20, 25, 35, 40

$$5 \times 2^2, 5^2, 5 \times 7, 5 \times 2^3$$

$$\text{HCF} = 5^2 \times 2^3 \times 7 = 1400.$$

15)

$$\text{LCM of fraction} = \frac{\text{LCM of Numerator}}{\text{HCF of Denominator}}$$

$$\text{HCF of fraction} = \frac{\text{HCF of numerator}}{\text{LCM of Denominator}}$$

GoCareer.in

CLASS
47

- ⑭ The ratio of two no. is 3:4 and their LCM is 60. find their HCF.

$$\text{HCF} = x$$

$$3 : 4$$

$$3x : 4x$$

$$x \times 3 \times 4 = 60$$

$$\boxed{x=5}$$

GoCareer.in

$$\text{NO's} = 15, 20.$$

- ⑮ The sum of two no. is 36 and their HCF is 4. find the possible no. of pairs.

$$\text{HCF} = 4$$

$$x : y$$

$$4x + 4y = 36$$

$$x + y = 9$$

$$(1, 8)$$

$$(2, 7)$$

$$(4, 5)$$

3 pairs are possible

- ⑯ The LCM of 4 no's is 117 and the HCF of each pair is 3 find the multiplication of all the numbers.

$$\text{HCF} = 3$$

$$\text{no's} = 3a, 3b, 3c, 3d$$

$$\text{LCM} = 3abcd = 117$$

$$abcd = 39$$

$$81abcd = 81 \times 39$$

$$(\because 3 \times 3 \times 3 \times 3 = 81)$$

Product of N no's

$$\boxed{(\text{HCF})^{n-1} \times \text{LCM}}$$

$$\underline{\text{or}} \quad (3)^3 \times 117$$

$$= 27 \times 117$$

7) The LCM and HCF of two consecutive even no's is 84 and 2. find the sum of reciprocal of these two no's.

$$\begin{aligned} \text{HCF} &= 2 \\ \text{no's} &= 2a, 2b \\ \text{LCM} &= 2ab \end{aligned}$$

$$2ab = 84$$

$$ab = 42$$

$$\begin{array}{cc} 6 \times 7 \\ \downarrow \quad \downarrow \\ a \quad b \end{array}$$

$$\text{no's} = 12, 14$$

$$\text{sum of reciprocals} = \frac{1}{12} + \frac{1}{14} = \frac{7+6}{84} = \frac{13}{84}$$

$$\begin{array}{cc} 6 & 8 \\ \hline & \\ 2 & (3, 4) \\ \hline & \end{array}$$

GoCareer.in

18) The sum and LCM of two no's are 156 and 504. find both the numbers.

$$\text{sum} = 156 \quad \text{LCM} = 504$$

$$\text{HCF} = 12$$



The HCF of sum and LCM of two no's is also the HCF of these two no's

12 will also be the HCF of the two no's.

$$\begin{aligned} \text{HCF} &= 12 \\ \text{no's} &= 12a, 12b \\ 12a + 12b &= 156 \\ a + b &= 13 \end{aligned}$$

$$\text{LCM} = 12ab = 504$$

$$ab = 42$$

$$\begin{aligned} \therefore a &= 6 \\ b &= 7 \end{aligned}$$

19) The sum and LCM of two no is 132 and 360
find two no's.

2	132
2	66
3	33
	11

2	360
2	180
2	90
3	45
3	15
	5

HCF = $2 \times 2 \times 3 = 12$

HCF of two no = 12

let no's = $12a, 12b$

$12a + 12b = 132$

$12(a+b) = 132$

$a+b = 11$

$a = 5$

$b = 6$ Ans

LCM = $12ab = 360$

$ab = 30$

20) The HCF of two no's is 11 and their LCM 693. If one no is 77. find the other number.

HCF = 11

LCM = 693

$LCM \times HCF = I \times II$

$693 \times 11 = 77 \times II$

$II = 99$



21) The LCM of two no is 12 times of HCF. The sum of HCF and LCM is 403. if both no are smaller than LCM. find both the number.

HCF = H

LCM = 12H

LCM + HCF = 403

$12H + H = 403$

$13H = 403$

$H = 31$

HCF = 31

LCM = $31 \times 12 = 372$

NO's are = $31x, 31y$

LCM = $31xy = 31 \times 12$

$xy = 12$

$(1, 12) \rightarrow (31 \times 1, 31 \times 12)$

$(3, 4) \rightarrow (31 \times 3, 31 \times 4)$

99, 124 Ans.

Maths (Volume-2)

22) The sum and diff. of HCF and LCM of two no. is 592 and 518. find both the numbers if sum of these two no. is 296.

$$L + H = 592$$

$$L - H = 518$$

$$L = 555$$

$$H = 37$$

$$\text{No's} = 37x, 37y$$

$$\text{LCM} = 37xy = 555$$

$$xy = \frac{555}{37} = 15$$

$$37x + 37y = 296$$

$$x + y = 8$$

$$x = 5$$

$$y = 3$$

$$\text{No's} = 37 \times 5 = 185$$

$$37 \times 3 = 111$$

23) Find the smallest no. w/c when divided by 5, 6, 8 and 9 gives remainder 3 in each case.

$$5, 6, 8, 9$$

$$\text{LCM} = 360$$

smallest no. w/c gives 3 remainder when divided

$$\text{by } 5, 6, 8, 9 = 360 + 3 = 363$$

24) if a farmer ~~had~~ ^{pack} 5 or 6 oranges in each box, he is left with 3 oranges. But if he pack 8 or 9 oranges in each box, he is left with 3 oranges. find the no. of oranges that he had.

$$5, 6, 8, 9$$

$$\text{LCM} = 360$$

$$+ 3$$

$$363 \text{ — No. of oranges.}$$

25) Find the smallest no. w/c when divided by 20, 25, 35 and 40 gives remainder 14, 19, 29 and 34.

20, 25, 35, 40	LCM = 1400
R → $\frac{-14}{6} \quad \frac{19}{6} \quad \frac{29}{6} \quad \frac{34}{6}$	$\begin{array}{r} 1400 \\ - 6 \\ \hline 1394 \end{array}$ Ans.

26) Find the smallest no. w/c when divided by 5, 6, 7 & 8 gives remainder 3 in each case. but it exactly divided by 9

5, 6, 7, 8 LCM = 840

$$\begin{array}{r} + 3 \\ \hline 843 \end{array} \rightarrow$$
 But ये 9 से divide नहीं हो रही

$840K + 3$

$$\begin{array}{r} 93 \\ 9 \overline{)840} \\ \underline{81} \\ 30 \\ \underline{27} \\ 3 \end{array}$$

$837K + 3K + 3$

↓
exactly divide by 9

↓
for what value of K

it will divided by 9 ⇒ K = 2

∴ $840 \times 2 + 3 = 1683$ Ans.

27) Find the smallest no. w/c when divided by 3, 4, 5 and 6 gives remainder 2, 3, 4 and 5. but exactly divide by 7.

3, 4, 5, 6

R → $\frac{-2}{1} \quad \frac{3}{1} \quad \frac{4}{1} \quad \frac{5}{1}$

LCM = 60

$60K - 1$

$\frac{4K - 1}{K = 2}$

K = 2

$$\begin{array}{r} 8 \\ 7 \overline{)60} \\ \underline{56} \\ 4 \end{array}$$

∴ $60 \times 2 - 1 = 119$ Ans.

28) Find the least multiple of 13 w/c when divided by 3, 4, 5 and 6 gives remainder 1, 2, 3 and 4.

$$3, 4, 5, 6$$

$$R \rightarrow \frac{1}{2} \quad \frac{2}{2} \quad \frac{3}{2} \quad \frac{4}{2}$$

LCM = 60

$60K - 2$

$52K + 8K - 2$

$$13 \overline{) 60} \begin{array}{r} 4 \\ 52 \\ \hline 8 \end{array}$$

GoCareer.in

$K = 1, 2, 3, 4, 5, 6, 7, 8, 9, 10$
for $K = 10$ it will be divided by 13.

$60K - 2$
 $= 600 - 2 = 598$ Ans.

29) Find the smallest no. of 6 digit w/c when divided by 3, 4, 5 and 6 gives remainder 2.

3, 4, 5, 6

LCM = 60

20) $60 \overline{) 100000} \begin{array}{r} 1666 \\ 60 \\ \hline 400 \\ 360 \\ \hline 400 \\ 360 \\ \hline 400 \\ 360 \\ \hline 40 \end{array}$

$$\begin{array}{r} 1,00,000 \\ + 20 \\ \hline 1,00,020 \\ + 2 \\ \hline 1,00,022 \end{array} \quad \underline{\underline{\text{Ans.}}}$$

30) Find the largest no. of 6 digit w/c when divided by 3, 4, 5, 6 and 8 gives remainder 1, 2, 3, 4 and 6.

3, 4, 5, 6, 8

LCM = 120

$120 \overline{) 999999}$

R → $\frac{1}{2} \quad \frac{2}{2} \quad \frac{3}{2} \quad \frac{4}{2} \quad \frac{5}{2}$

$$\begin{array}{r} 999999 \\ - 39 \\ \hline 999960 \\ - 2 \\ \hline 999958 \end{array} \quad \underline{\underline{\text{Ans.}}}$$

39

31) Find the least perfect square no. w/c when divided by 4, 5, 6 gives remainder zero.

4, 5, 6

LCM = 60

$$\underbrace{2 \times 2} \times \underbrace{3 \times 5} \times \underbrace{2} \times \underbrace{5}$$

multiply by 3 & 5
to make pair

$$60 \times 3 \times 5 = 900$$

32) Two cog wheels having 16 and 24 teeth respectively

The bigger wheel makes 5 revolutions per hour.

calculate how many times the specific teeth of bigger wheel meets with the specific teeth of smaller wheel in 11 hours.

33) Three runners A, B and C run along a circular path of 12 km long with speeds 3 km/hr, 7 km/hr, 13 km/hr. They start their race from the same point for the same destination. After how much time they will meet again.

34) 4 bells rings at an interval of 12 sec, 15 sec, 20 sec and 30 sec resp. How much time will they ring together in 6 Hours.

1st time they rang together.

$$\text{LCM of } 12, 15, 20, 30 = 60$$

$$\frac{6 \times 3600}{60} = 360$$

$$\frac{360}{+1} = 361 \text{ times}$$

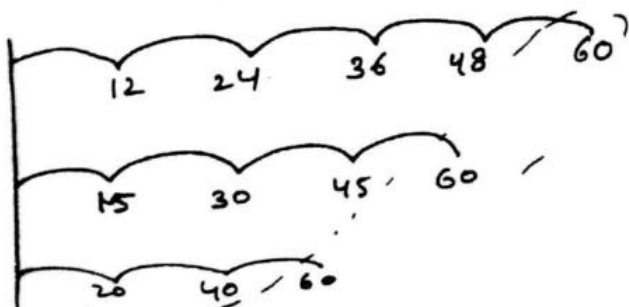

32

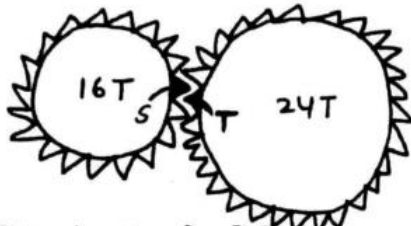

एक बार starting में दोनों wheel मिले हैं।

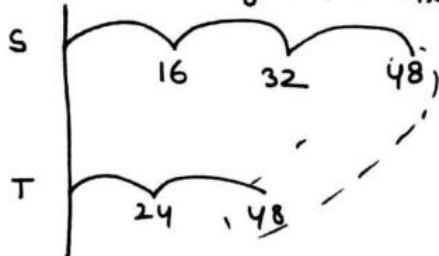

LCM of (16, 24) = 48

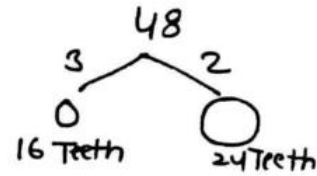

बड़ा wheel जब 2 चक्कर काटेगा तो वो एक बार छोटे wheel से मिलेगा (किसी specific teeth से)

Bigger wheel makes 5 revolutions per Hour

so in 11 Hours = 55 revolutions.

when Bigger wheel makes 2 revolutions it meets with the specific teeth of smaller wheel 1 time.

2 revolution	_____	1 time
20 11	_____	10 time
54 revolution	_____	27 time

$$\begin{array}{r} 27 \\ + 1 \rightarrow \text{start wala} \\ \hline 28 \text{ times} \end{array}$$

Ans

33

A	B	C
12 km	12 km	12 km
$\frac{12}{3}$	$\frac{12}{7}$	$\frac{12}{13}$



GoCareer.in

$$LCM = \frac{LCM(12, 12, 12)}{HCF(3, 7, 13)} = \frac{12}{1} = 12 \text{ Hrs}$$

After 12 Hours they will meet again.

Q: 32, 33, 34 - ऐसे Que. में Time का LCM लेते हैं।

CLASS
48

GEOMETRY

①

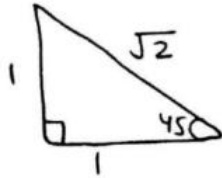
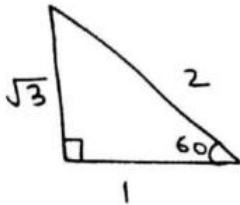
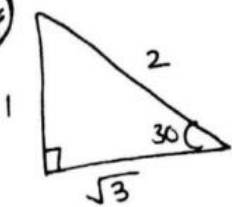

Alternate interior angle

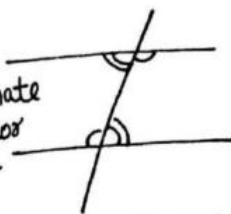

Alternate exterior angle

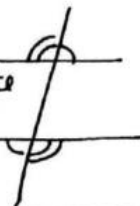

Corresponding angle



180°

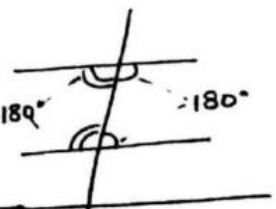

①

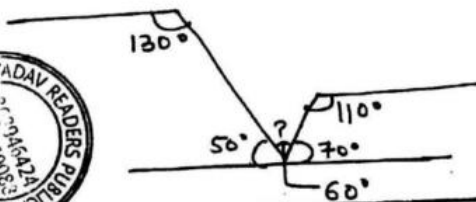

② A, B, C, D are the vertex of a Rhombus and P, Q, R, S are the mid points of AB, BC, CD & DA. find the largest angle of the rhombus? & $CP \perp AB$

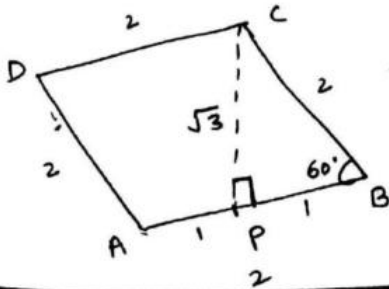

$$\angle DAB = 180 - 60 = 120^\circ$$

③

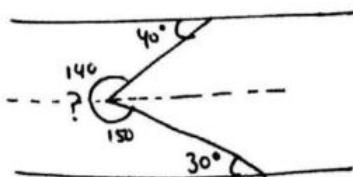

$$140 + 150 = 290^\circ$$

4



$$x+y+z = ?$$

$$180-x+180-y = z$$

$$x+y+z = 360^\circ$$

5

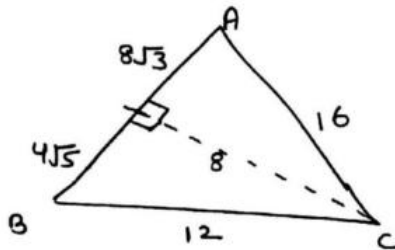
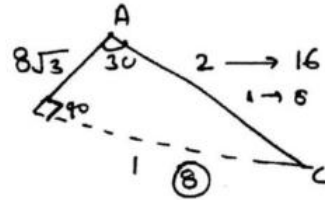
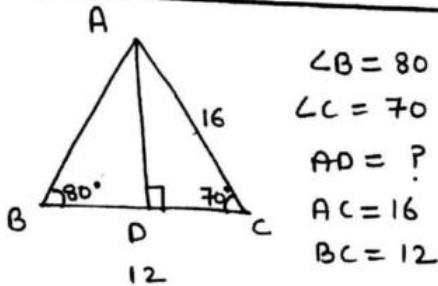

Area ($\triangle ABC$)

$$\frac{1}{2} (8\sqrt{3} + 4\sqrt{3}) \times 8 = \frac{1}{2} \times 12 \times AD$$

$$AD = \frac{2}{3} (8\sqrt{3} + 4\sqrt{3})$$

#

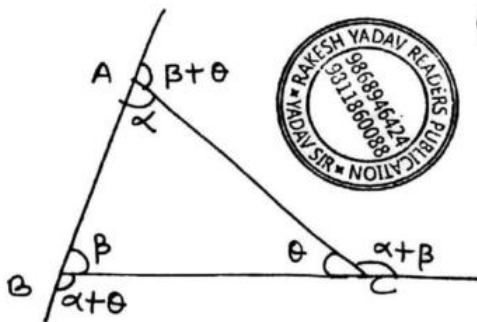

#

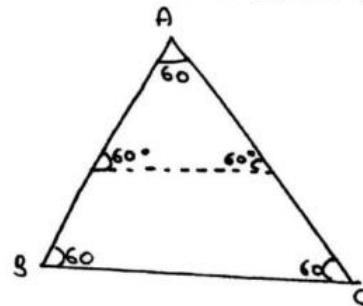

6

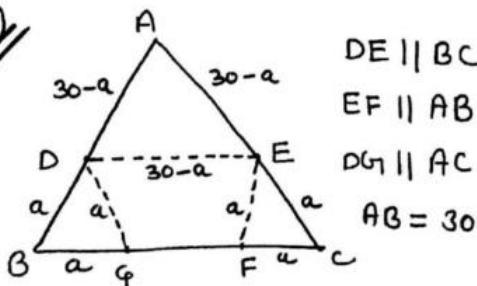

$$GD + DE + EF = 42$$

$$GF = ?$$

$$AB = BC = CA$$

$$30 - a + a = 42$$

$$a = 12$$

$$GF = 30 - 12 - 12 = 6 \text{ cm}$$

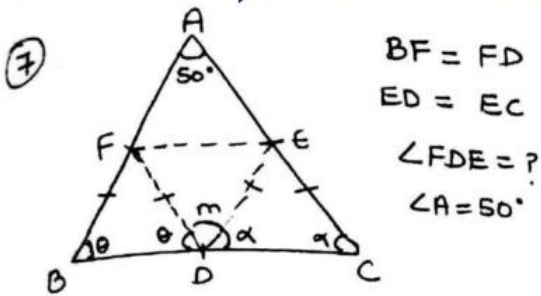

BF = FE
 ED = EC
 $\angle FDE = ?$
 $\angle A = 50^\circ$

$\angle A + \angle B + \angle C = 180^\circ$
 $50^\circ + \theta + \alpha = 180^\circ$
 $\theta + \alpha = 130^\circ$

$\therefore \theta + \alpha + m = 180^\circ$
 $130^\circ + m = 180^\circ$

$m = 50^\circ$

GoCareer.i

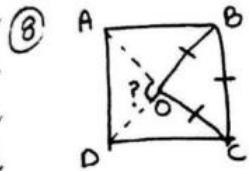

ABCD is a square.
 OBC is equilateral Δ
 find angle $\angle AOD$.

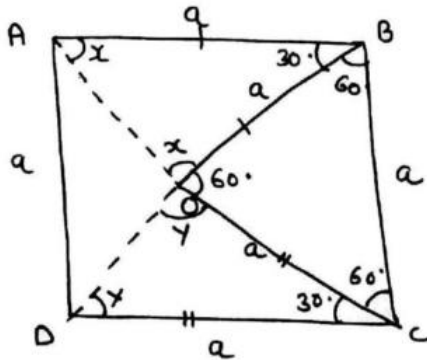
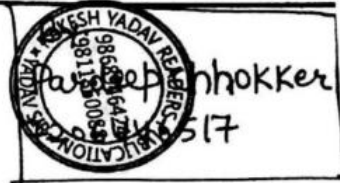

ΔABO
 $x + x + 30^\circ = 180^\circ$
 $x = 75^\circ$

ΔCDO
 $y = 75^\circ$

$\therefore \angle AOD = 75 + 75 + 60 + \angle AOD = 360$

$\angle AOD = 150^\circ$

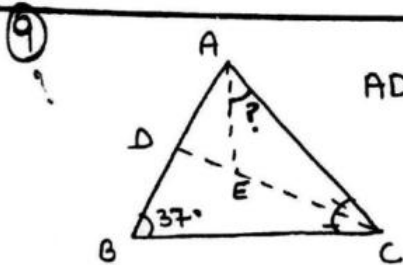

AD = AE

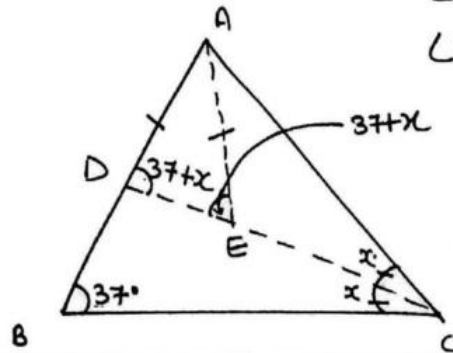

$\angle ADE = 37 + x$
 $\angle AED = 37 + x$
 \downarrow
 External angle
 of ΔACE
 $\therefore \angle EAC = 37^\circ$

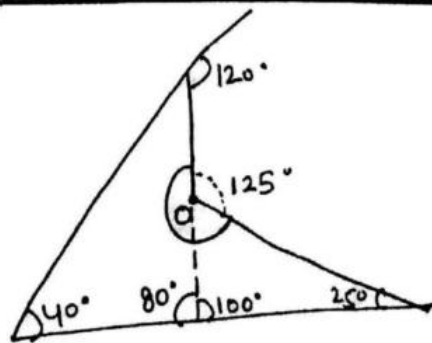
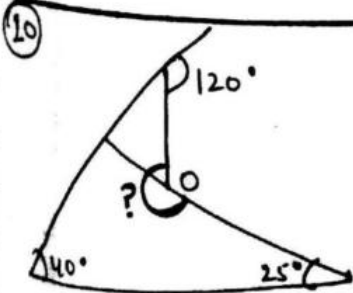

$360 - 125^\circ$
 $= 235^\circ$ Ans

(11) $BC=CD$

$\angle ABC - \angle BAD = 30^\circ$

$\angle ABD = ?$

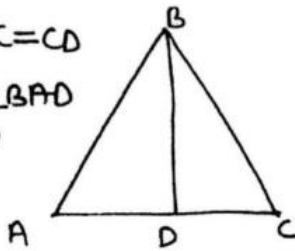

$\angle B = \alpha, \angle A = \theta$

$\angle BDC = \theta + \alpha$

$\angle DBC = \theta + \alpha$

$\angle ABC - \angle BAD = 30^\circ$

$2\alpha + \theta - \theta = 30^\circ$

$\alpha = 15^\circ$

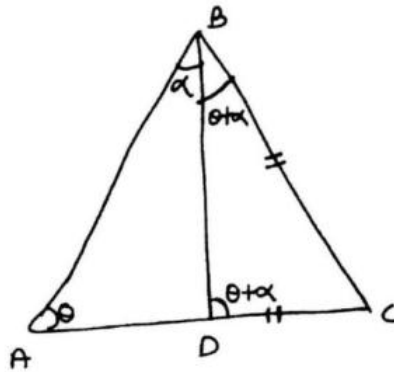

GoCareer.in

(12) In an obtuse angle $\triangle ABC$ the external angle bisector of $\angle A$ intersect the extended part of line CB at M and the external angle bisector of $\angle C$ intersect the extended part of line AB at N .

$MA = AC = CN$

$\angle B = ?$

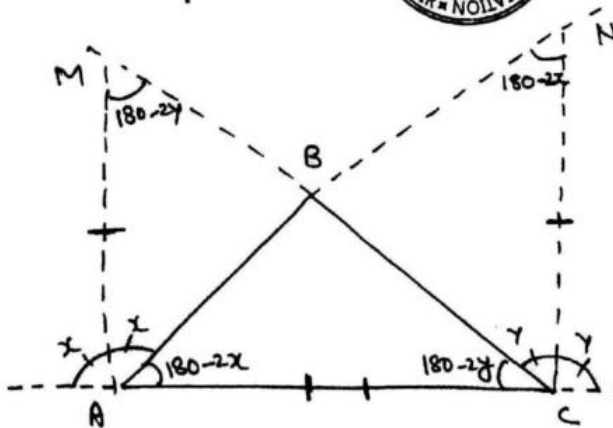

$\triangle MAC$

$180 - 2y + 180 - 2y + x + 180 - 2x = 180$

$x + 4y = 360^\circ$

$\triangle NAC$

$180 - 2x + 180 - 2x + 180 - 2y + y = 180$

$4x + y = 360^\circ$

$\triangle ABC$

$\angle B + 180 - 2x + 180 - 2y = 180^\circ$

$B = 2(x + y) - 180^\circ$

$B = 288 - 180$

$B = 108^\circ$

$x + 4y = 360^\circ$

$4x + y = 360^\circ$

$5(x + y) = 720^\circ$

$x + y = 144^\circ$

CLASS
49

13

$\angle B = \angle C = 78^\circ$
 $\angle BCD = 24$
 $\angle EBC = 51$
 $\angle DEB = ?$

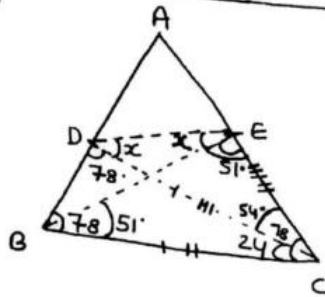

$DC = BC$
 $BC = EC$
 $\therefore DC = BC = EC$
 In $\triangle CDE$
 $x + x + 54 = 180$
 $x = 63$
 $\angle DEB = 63 - 51 = 12$

14

ABCD square
 BCN equilateral Δ .
 $\angle AOC = ?$

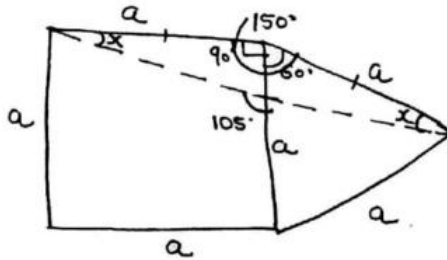

$x + x + 150 = 180$
 $x = 15$
 $\angle AOC = 90 + 15$
 $= 105$
 (external angle of $\triangle ABO$)

15

ABCD - square
 AC - diagonal
 COD - equilateral Δ

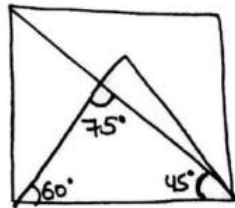

diagonal of the square is angle bisector

16

$AD = DB = BC$
 $AB = AC$
 $\angle B = ?$

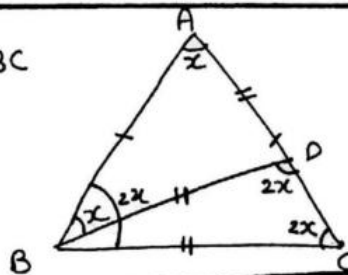

$\triangle ABC$
 $2x + 2x + x = 180$
 $x = 36$
 $\angle B = 72$

17

$AC = BC = AD$
 $\angle D = ?$

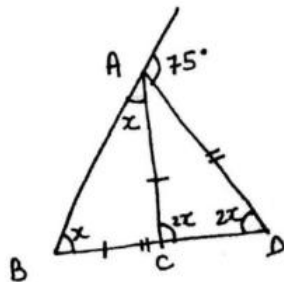

$2x + x = 75$
 $x = 25$
 $\angle D = 2 \times 25 = 50$

18)

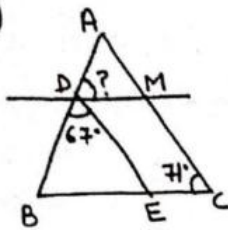

DE || AC
DM || BC
 $\angle ADM = ?$

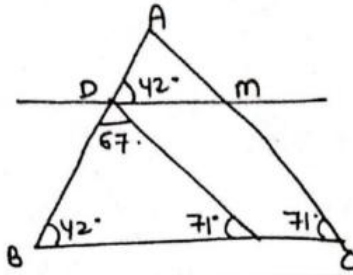

$\angle ADM = 42^\circ$

19)

The angle of elevation from a point on the base w/c is 160 m away is θ . After moving 100 m towards the tower the angle of elevation becomes double. find the height of the tower.

20) The angle of elevation from a point on the ground to a top of tower is 15° . After moving 100 m towards the tower the elevation becomes double. find the height of the tower.

19)

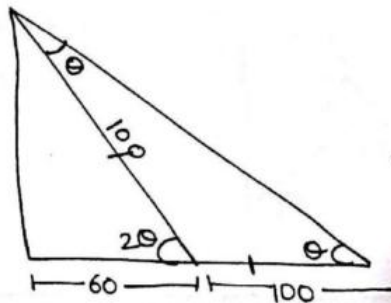

$$H = \sqrt{100^2 - 60^2}$$

$$= \sqrt{10000 - 3600}$$

$$= \sqrt{6400}$$

$$= 80 \text{ m.}$$

20)

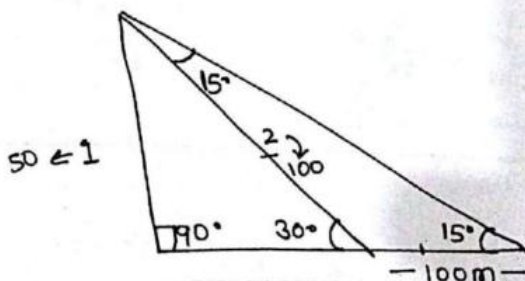

50 m.

GoCareer.in

21) A, B, C, D are the vertex of a Rhombus, the ~~extended part~~ of line AB & BA is extended to point P & E. The extended part of line EB & PC meets at T. find $\angle T$. $EA = AB = BP$

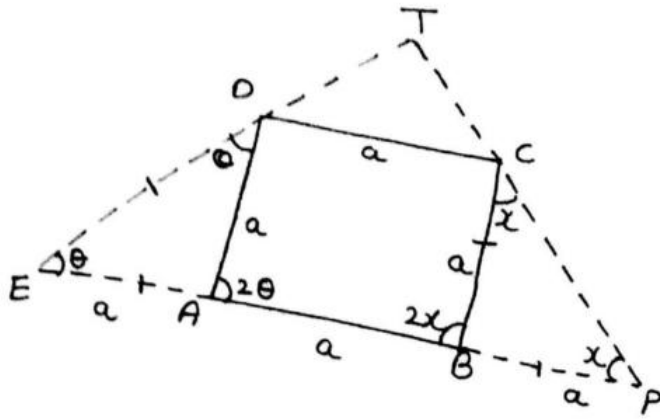

$$2\theta + 2x = 180$$

$$\theta + x = 90^\circ$$

ΔTEP

$$\angle T + \theta + x = 180^\circ$$

$$\angle T = 180 - 90$$

$$\angle T = 90^\circ$$

22

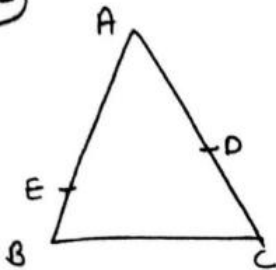

$$AD = DE = EC = BC$$

$$AB = AC$$

$$\angle A = ?$$

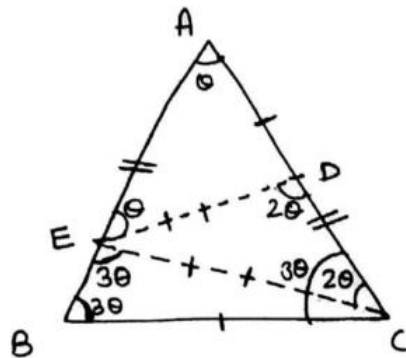

ΔABC

$$3\theta + 3\theta + \theta = 180^\circ$$

$$7\theta = 180$$

$$\theta = \frac{180}{7}$$

Important Triplets

3, 4, 5	18, 20, 30	9, 40, 41
6, 8, 10	5, 12, 13	8, 12, 15
9, 12, 15	10, 24, 26	
12, 16, 20	15, 36, 39	
15, 20, 25	7, 24, 25	

23

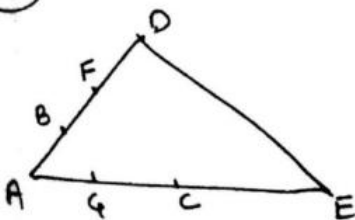

$$AB = BC = CD = DE =$$

$$EF = FG = GA$$

$$\angle CDE = ?$$

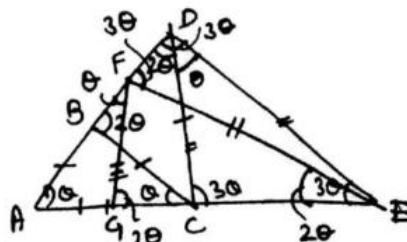

ΔADE

$$\theta + 3\theta + 3\theta = 180^\circ$$

$$7\theta = 180$$

$$\theta = \frac{180}{7}$$

अगर figure ऐसे zig-zag हो, तो देखो कितनी side equal दे रखी है। यहाँ 7 sides equal दे रखी हैं तो angle होगा $\frac{180^\circ}{7}$

GoCareer.in

24

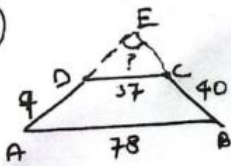

$\angle DEC = ?$

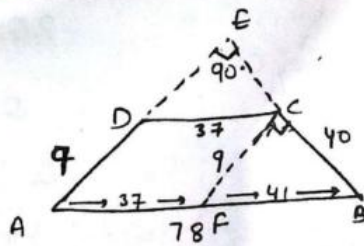

ΔBCF (right angle)

$\angle BCF = 90^\circ$

$AD \parallel FC$

BE transversal line

$\therefore \angle DEC = \angle BCF$

$\angle DEC = 90^\circ$

CENTERS

Circumcentre

where perpendicular bisector of all sides meet.

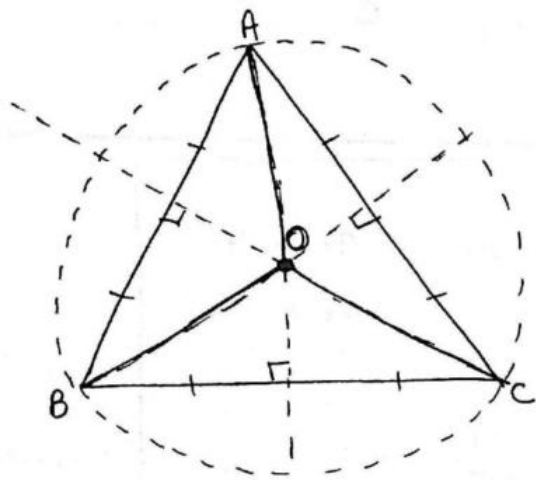

we can not calculate the length of perpendicular bisector because it has no end points.

$$OA = OB = OC = R \text{ (Circum-radius)}$$

Circumcentre in obtuse angle $\Delta \rightarrow$

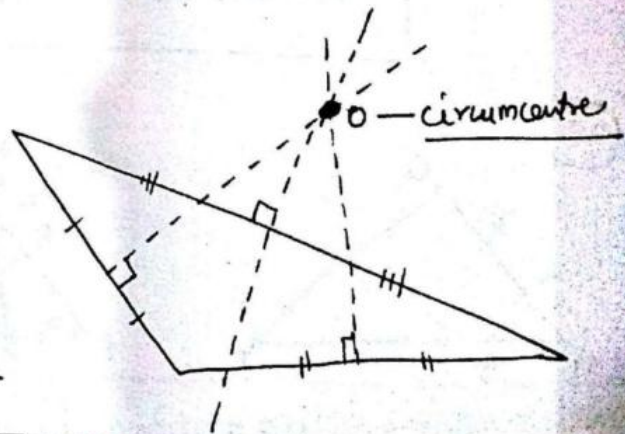

GoCareer.in

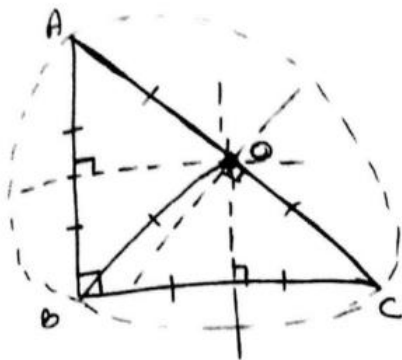

$OA = OB = OC = R$

By:
Pardeep Chokker
7206446517

⊗

M is the mid point of AC.

$BM = AM = MC = R$

⊗

$\frac{1}{2} \times 6 \times 8 = \frac{1}{2} \times 10 \times P$

$P = 4.8$

GoCareer.in

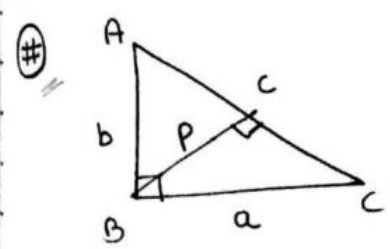

$\frac{1}{P} = \frac{ab}{c^2}$

$\frac{1}{P^2} = \frac{a^2 + b^2}{a^2 b^2}$

$\frac{1}{P^2} = \frac{1}{b^2} + \frac{1}{a^2}$

Centroid

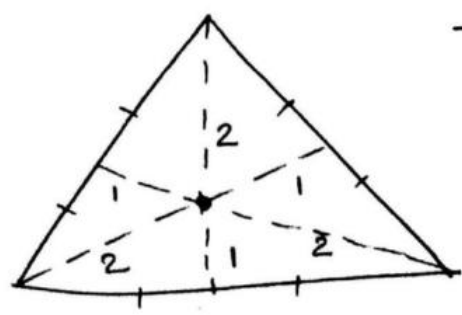

- where 3 medians intersect
 - median divide the side in two equal parts.
- Vertex : Base = 2 : 1

25) In a ΔABC , G is centroid

$AG = BC$
 $\angle BGC = ?$

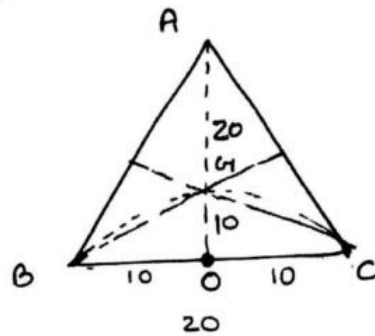

$O \rightarrow$ centre
 draw a semicircle
 $\angle BGC = 90^\circ$
 (angle in semi-circle)

26) find the area of a right angle Δ in w/c a median of length 20cm intersect the right angle in the ratio 2:1

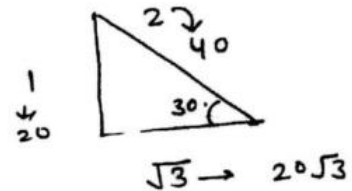
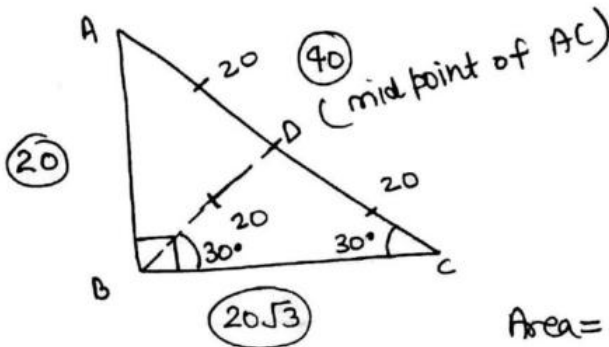

Area = $\frac{1}{2} \times 20\sqrt{3} \times 20 = 200\sqrt{3}$ Ans

27) In a ΔABC , G is centroid

$AB = 5$, $BC = 12$
 $CA = 13$, $BG = ?$

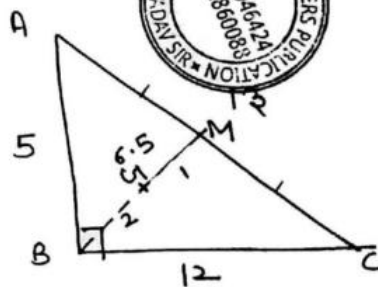

$AM = MC = BM$
 $= 6.5$
 $2 : 1$
 $BG = \frac{13}{\frac{6.5}{1.5}} \times \frac{2}{3}$
 $\frac{13}{3}$ Ans

28) In a ΔABC , G is centroid

$AB = 6$
 $BC = 8$
 $CA = 10$
 $BG = ?$

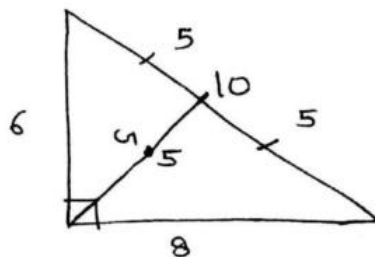

5
 $2 : 1$
 $BG = 5 \times \frac{2}{3}$
 $\frac{10}{3}$

29) In a ΔABC , BD & CE are the two medians w/c intersect each other at right angle. $\sqrt{112}$

$AB = 22$
 $AC = 19$
 $BC = ?$

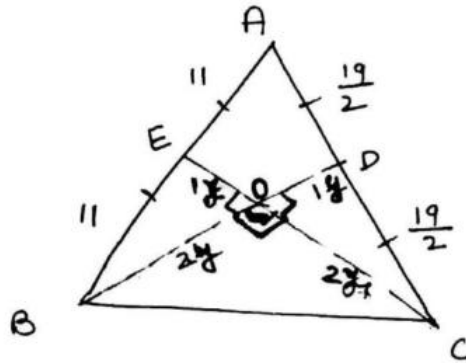

$$4x^2 + y^2 = \frac{361}{4} \quad (\Delta COD)$$

$$x^2 + 4y^2 = 121 \quad (\Delta BOE)$$

$$5(x^2 + y^2) = \frac{845}{4}$$

$$x^2 + y^2 = \frac{169}{4}$$

$$\therefore 4x^2 + 4y^2 = 169$$

$$BC^2 = 4x^2 + 4y^2$$

$$BC^2 = 169$$

$$BC = 13$$

OR

$$BC = \sqrt{\frac{AB^2 + AC^2}{5}}$$

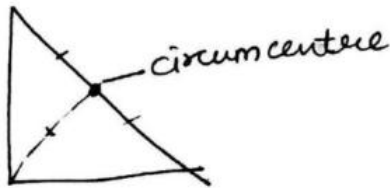

Orthocentre

Meeting point of three altitudes

GoCareer.in

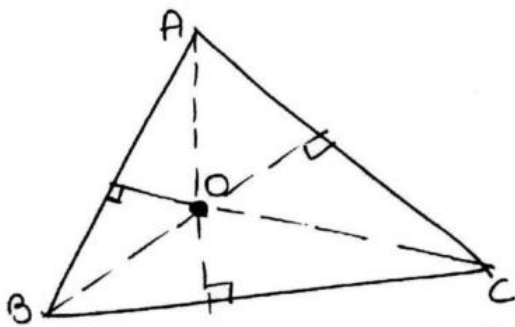

30) In a acute angle ΔABC , O is orthocentre. $\angle A = 50^\circ$, $\angle BOC = ?$

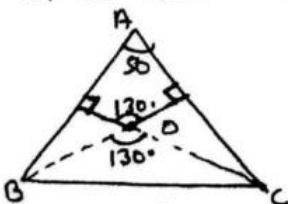

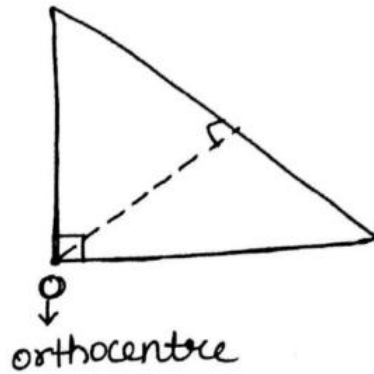
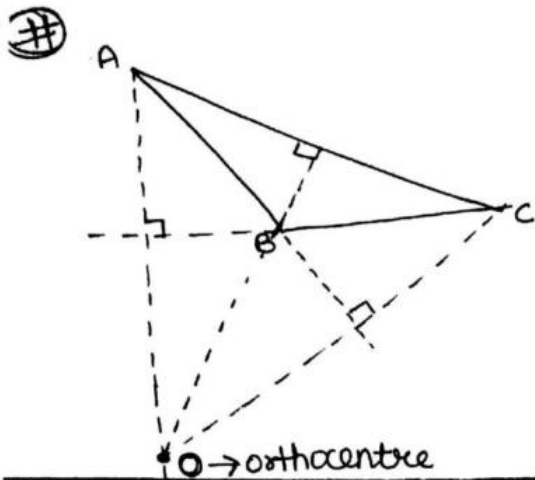

31) In obtuse angle Δ , obtuse angle is 110° . find the angle made on its orthocentre-

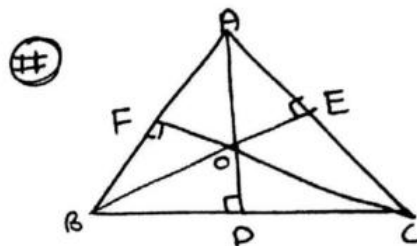
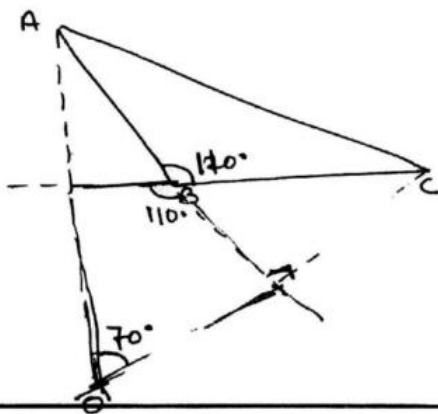

$O \rightarrow$ orthocentre
 vertex $E \rightarrow$ is the orthocentre of ΔAOC
 $\Delta AOE, \Delta ABE, \Delta COE, \Delta BEE$.
 vertex $B \rightarrow$ orthocentre of ΔAOC

32) The length of the sides of a Δ are 6, 8, 10 cm. find the distance from its orthocentre to circumcentre.

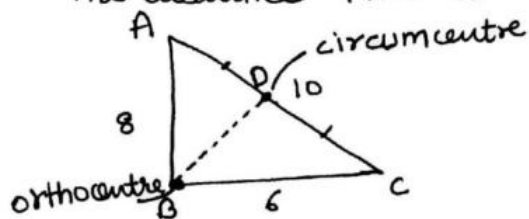

$D \rightarrow$ circumcentre
 $AD = DC = 5$
 $AD = DC = BD = R$
 $\therefore BD = 5$

Incentre meeting point of angle bisector

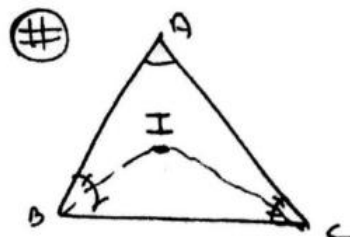
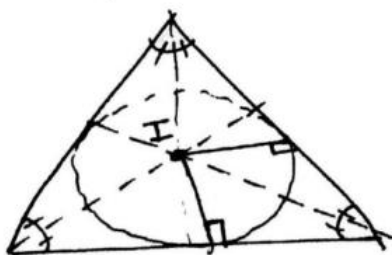

$\angle I = 90 + \frac{1}{2} \angle A$

CLASS
50

- ⊕ The same line represents the median from the right angle vertex and the circumcircle radius in a right angle Δ .
- ⊕ In right angle Δ , the distance b/w orthocentre and circumcentre is equal to the circumradius of the Δ .

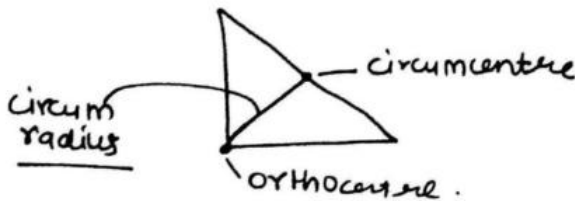

- ⊕ Incentre is the only centre w/c is equi perpendicular distance from all the sides of the Δ and circumcentre is the only centre w/c have equal distance from all the vertex.

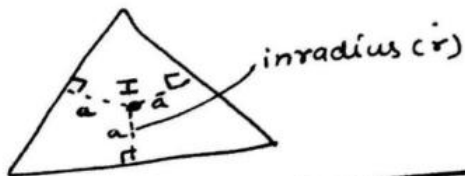

GoCareer.in

Similarity

(A)



if two angles are equal then Δ 's are similar.

(B)

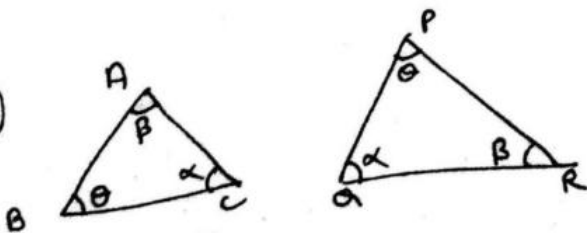

$$\frac{AC}{QR} = \frac{AB}{PR} = \frac{BC}{PQ} = \frac{P(\Delta ABC)}{P(\Delta PQR)} = \frac{\text{median of } \Delta ABC}{\text{median of } \Delta PQR}$$

$$= \frac{\text{Angle Bisector of } \Delta ABC}{\text{Angle Bisector of } \Delta PQR} = \frac{\text{Altitude of } \Delta ABC}{\text{Altitude of } \Delta PQR}$$

33

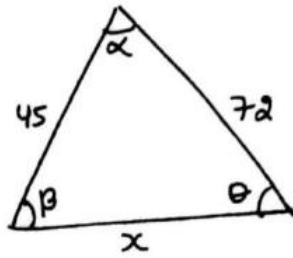
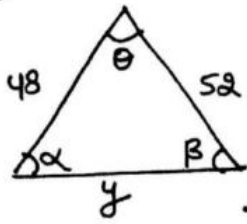

$x+y = ?$

$$\frac{y}{45} = \frac{48-2}{72-3}$$

$y = 30$

$$\frac{x}{52} = \frac{72-3}{48-2}$$

$x = 78$

$x+y = 108$

$$\frac{48}{72} = 2 : 3$$

2 → 52
1 → 26

3 → 78 = x

Now 3 — 45
1 — 15

2 → 30 = y

$x+y = 108$

34

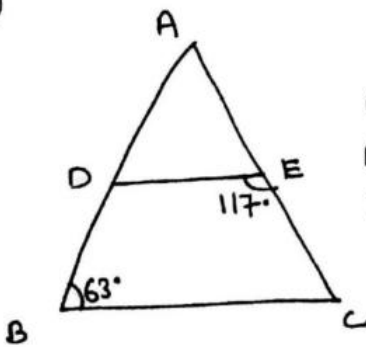

AD=4
AB=12
AE=5
EC=?

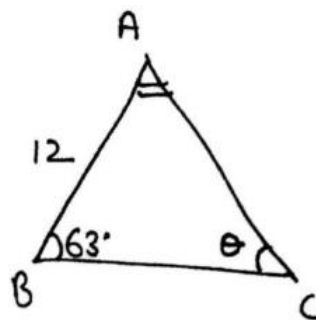
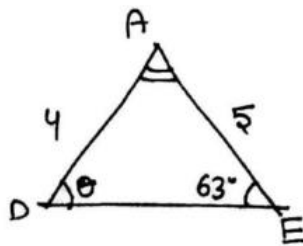
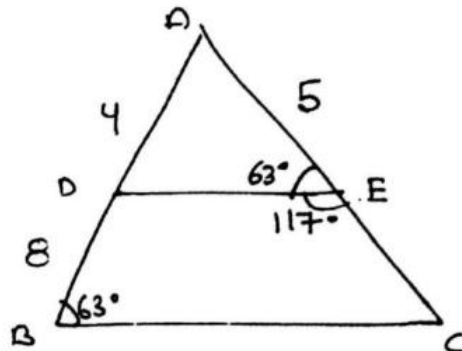

$$\frac{AC}{4} = \frac{12}{5}$$

$AC = \frac{48}{5} = 9.6$

$EC = 9.6 - 5 = 4.6$

Ans

35

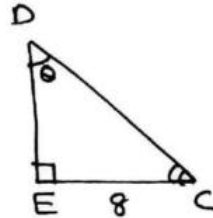
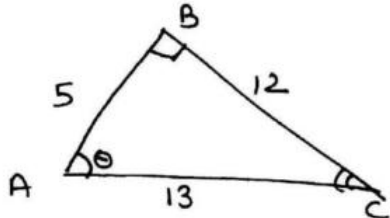
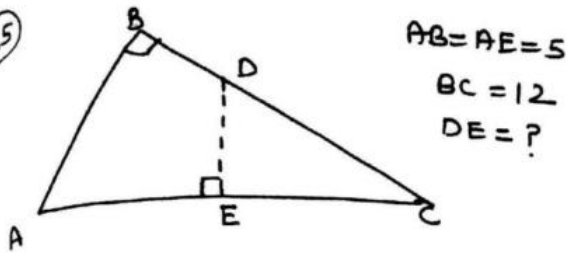

$AE = 5$
 $AC = 13$
 $EC = 8$

$\frac{DE}{5} = \frac{10}{13}$

$DE = \frac{10}{3}$

OR

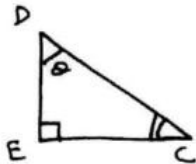

$\tan \theta = \frac{DE}{8}$

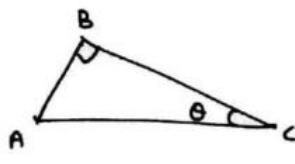

$\tan \theta = \frac{5}{12}$

$\frac{DE}{8} = \frac{5}{12}$

$DE = \frac{10}{3}$

36

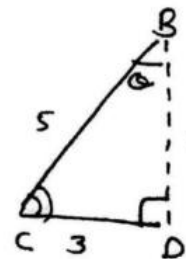
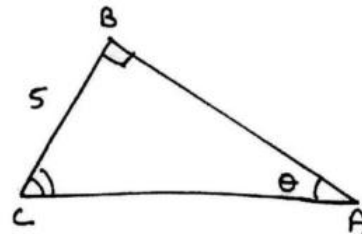
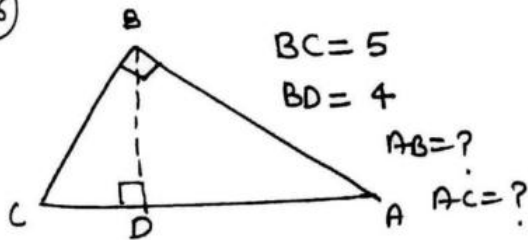

$\frac{AB}{4} = \frac{5}{3}$

$AB = \frac{20}{3}$

OR

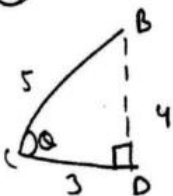

$\tan \theta = \frac{4}{3}$

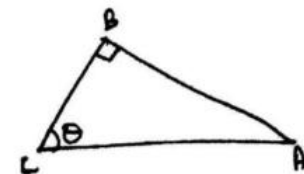

$\tan \theta = \frac{AB}{5}$

$\frac{AC}{5} = \frac{5}{3}$

$AC = \frac{25}{3}$

$AB = \frac{20}{3}$

37) In a right angle ΔABC , $AD \perp BC$. BC is the hypotenuse

$AC = 2AB$, $BD = ?$

- A) $\frac{BC}{2}$ C) $\frac{BC}{4}$
- B) $\frac{BC}{3}$ D) $\frac{BC}{5}$

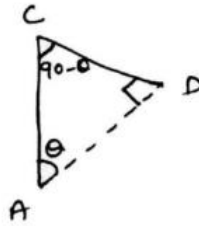
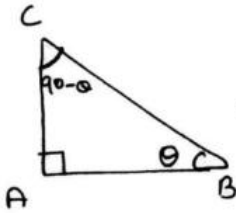
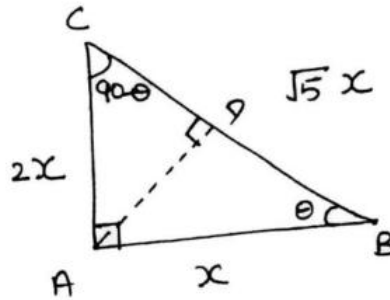

Imp

$$AC^2 = BC \times CD$$

$$AB^2 = BD \times BC$$

$$AD^2 = CD \times DB$$

$$\frac{AC}{CD} = \frac{BC}{AC} = \frac{AB}{AD}$$

$$AC^2 = BC \times CD$$

$$AB^2 = BD \times BC$$

$$AB^2 = BD \times BC$$

$$x^2 = BD \times \sqrt{5}x$$

$$BD = \frac{x}{\sqrt{5}}$$

$$= \frac{x}{\sqrt{5}} \times \frac{\sqrt{5}}{\sqrt{5}} = \frac{\sqrt{5}x}{5} = \frac{BC}{5}$$

$BD = \frac{BC}{5}$

Right angle isosceles Δ

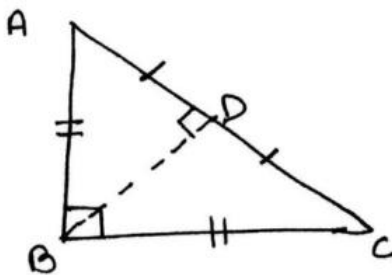

BD

- Median
- Altitude
- \perp bisector
- Angle bisector

$BD =$ line formed by joining orthocentre & circumcentre

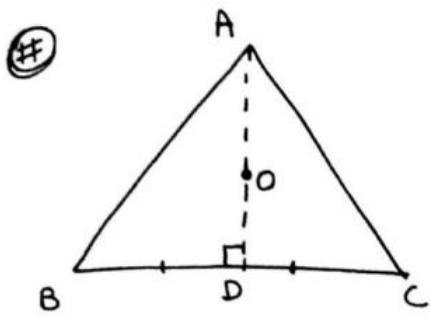

In equilateral Angle Δ
 Any median (AD) $\left\{ \begin{array}{l} \text{median} \\ \perp \text{bisector} \\ \text{Altitude} \\ \text{Angle bisector} \end{array} \right.$
 and all centre lie on the same place $\left\{ \begin{array}{l} \text{Circumcentre} \\ \text{orthocentre} \\ \text{centroid} \\ \text{incentre.} \end{array} \right.$

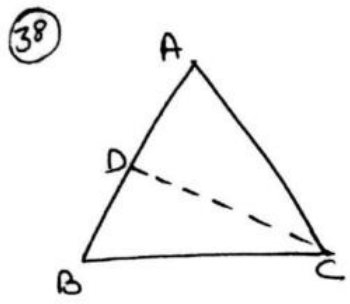

$\angle BAC = \angle BCD$
 $AD = 14$
 $BD = 18$
 $AC = 25$
 $BC = ?$

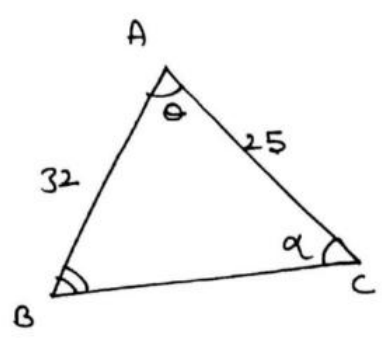

$$\frac{BC}{18} = \frac{32}{BC}$$

$$BC^2 = 576$$

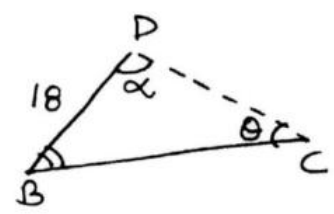

$BC = 24$

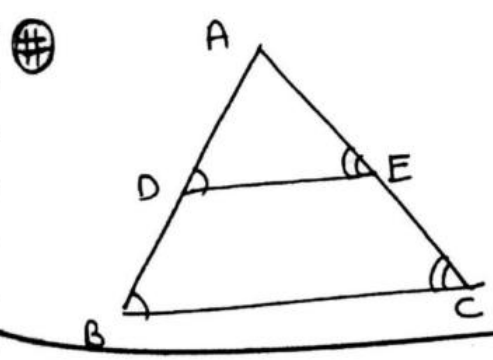

$$\frac{AD}{AB} = \frac{AE}{AC} = \frac{DE}{BC}$$

$$\frac{AD}{DB} = \frac{AE}{EC}$$

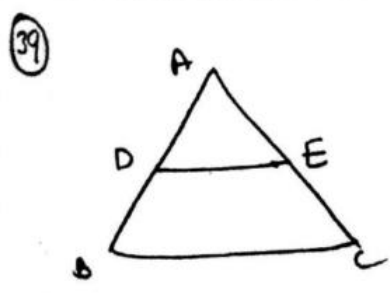

$$\frac{AD}{DB} = \frac{5}{3}$$

$$BC = 72$$

$$DE = ?$$

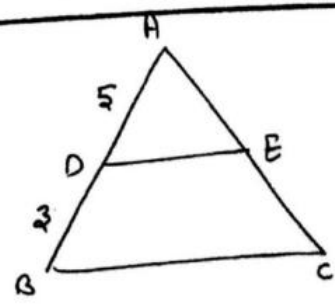

$$\frac{5}{8} = \frac{DE}{72}$$

$DE = 45$

#

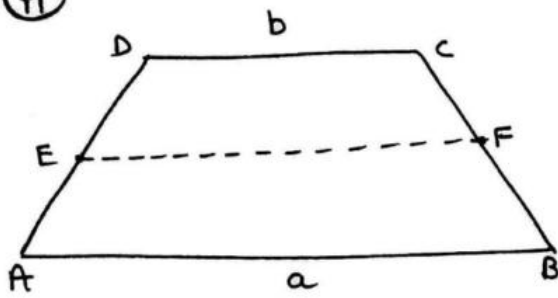

$$\frac{DE}{EA} = \frac{CF}{FB}$$

if E & F are mid points

$$EF = \frac{a+b}{2}$$

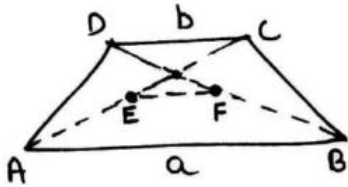

E & F are mid points of diagonals

$$EF = \frac{a-b}{2}$$

CLASS
SI

40

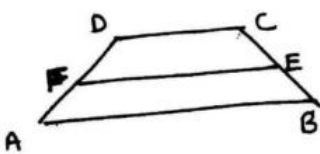

$AB \parallel DC \parallel FE$

$$\frac{DF}{FA} = \frac{3}{5}$$

$AB = 128$

$DC = 56$

$FE = ?$

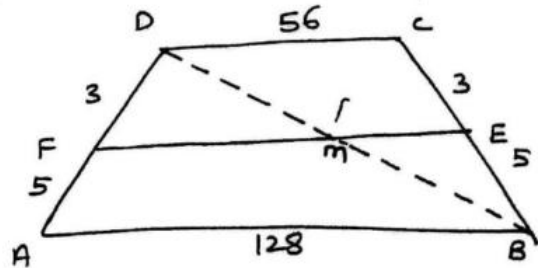

$\triangle ADB \sim \triangle DFM$

$$\frac{3}{8} = \frac{FM}{128}$$

$FM = 48$

$\triangle BCD \sim \triangle BEM$

$$\frac{5}{8} = \frac{ME}{56} \Rightarrow ME = 35$$

$FE = 48 + 35 = 83$

Ans.

OR

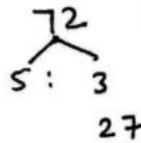
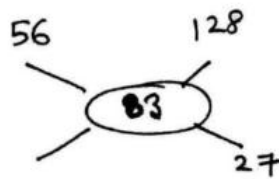

$5 : 3$

GoCareer.in

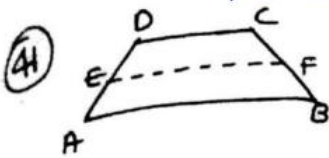

DC = 45
AB = 125
EF = ?

$$\frac{DF}{EA} = \frac{2}{3}$$

$$\Rightarrow \frac{2}{5} = \frac{EM}{\frac{125}{25}} \quad \boxed{EM = 50}$$

$$\Rightarrow \frac{3}{5} = \frac{MF}{\frac{45}{9}} \quad \boxed{MF = 27}$$

$$\boxed{EF = 50 + 27 = 77} \quad \underline{\text{Ans}}$$

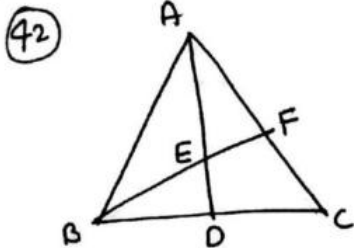
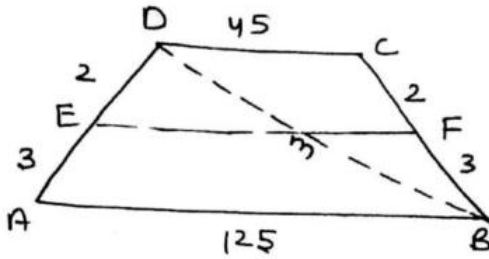

AE : ED = BD : DC = 3 : 4

AC = 370 cm

AF = ?

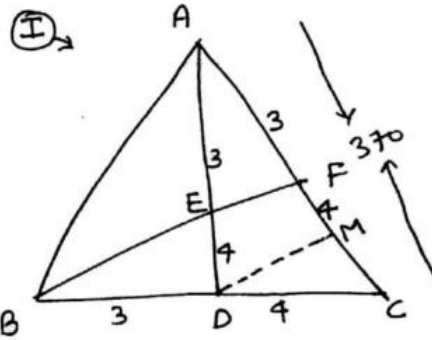

BF || DM

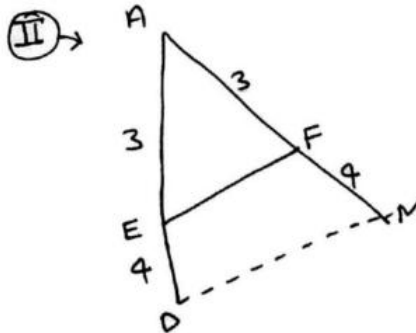
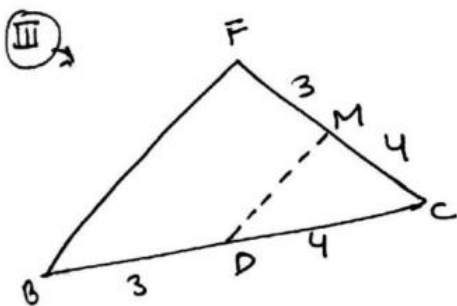

AF : FM = 3 : 4

AF	:	FM	:	MC
3	:	4	:	4
3	:	3	:	4
<hr/>				
9x		12x		16x

AF = 90
FM = 120
MC = 160

37x = 370

$\boxed{x = 10}$

43

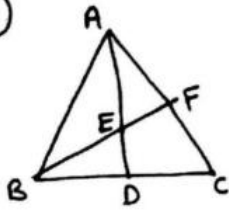

E is mid point of AD
 D is mid point of BC
 AC = 30 cm
 AF = ?

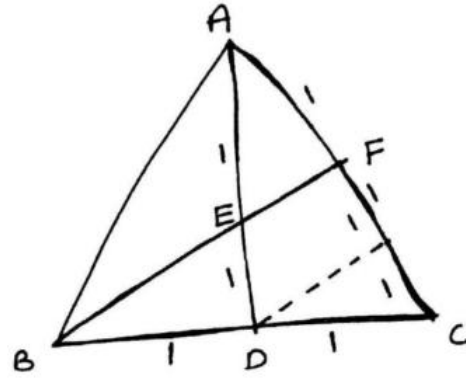

$$\begin{array}{r} AE : FM : MC \\ | : | : | \\ | : | : | \\ \hline | : | : | \end{array}$$

3 → 30
 1 → 10

AF = 10

44

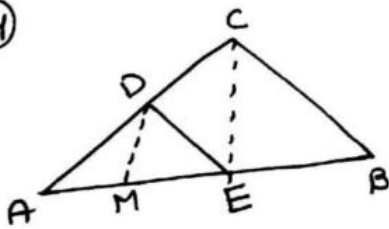

BC || DE
 CE || DM
 AE : EB = 2 : 3
 AM : MB = ?

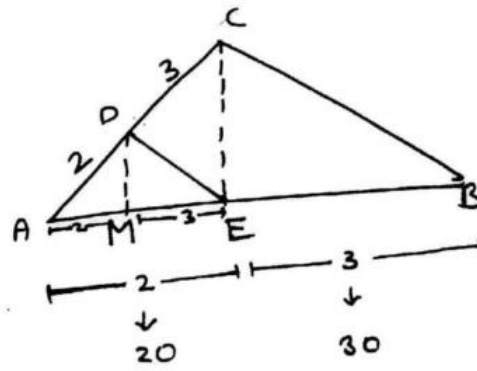

AE = 20
 EB = 30

AE = 2+3 = 5 → 20
 1 → 4

AM = 8, ME = 12, EB = 30

AM : MB
 8 : 42

4 : 21

Any

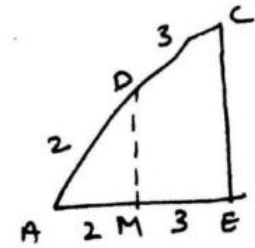

GoCareer.in

45

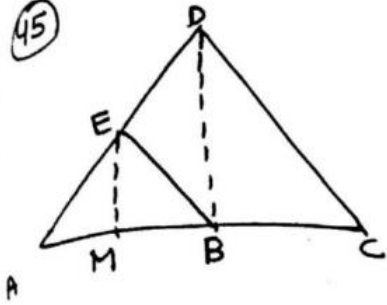

$AB : BC = 4 : 1$
 $MB : BC = ?$

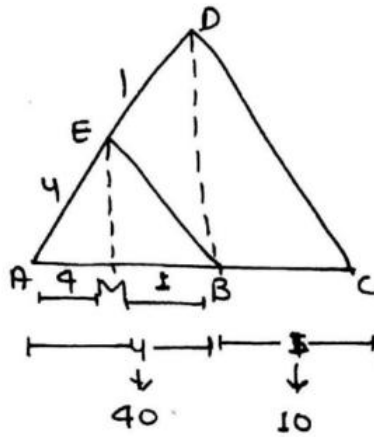

$AM = 32$
 $MB = 8$
 $BC = 10$

$MB : BC$
 $8 : 10$
 $4 : 5$

46

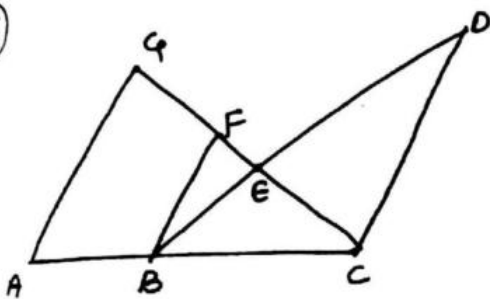

$FE = 5$
 $EC = 10$
 $DC = 18$
 $AG = 12$
 $GC = ?$
 $AG \parallel BF \parallel CD$

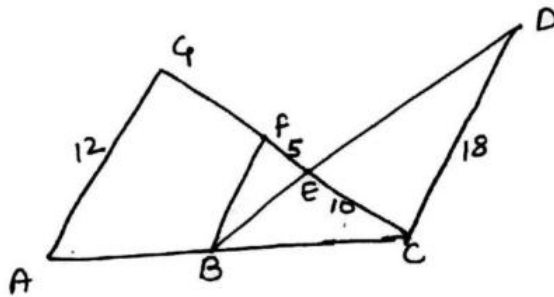

(I)

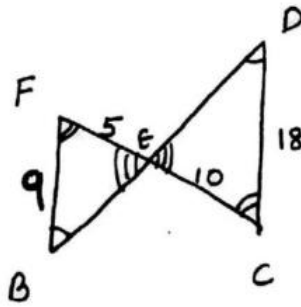

$FB \parallel CD$
 $BD \text{ \& } FC$
Transversal

$\frac{FB}{18} = \frac{5}{10}$ $FB = 9$

(II)

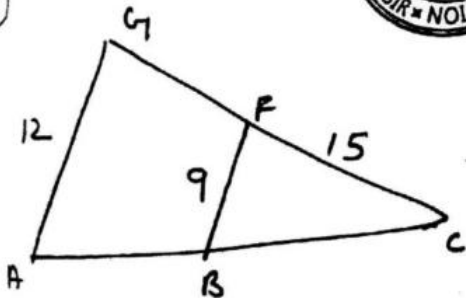

$\frac{15}{GC} = \frac{9}{12}$

$GC = 20$



47

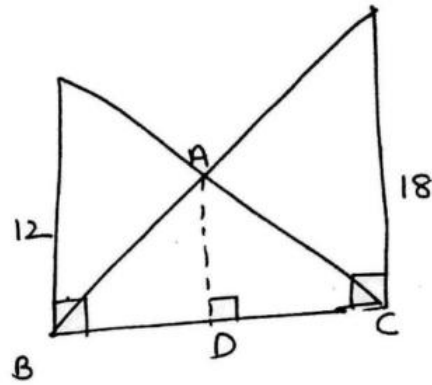
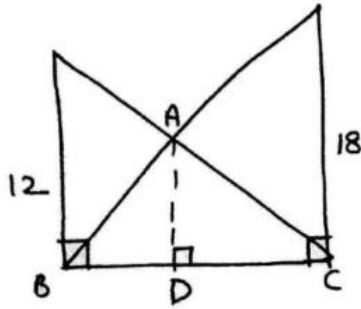

Area of $\Delta ABC = ?$

$BC = 6$

$$AD = \frac{12 \times 18}{30} = \frac{36}{5}$$

$$\text{Area } \Delta ABC = \frac{1}{2} \times 6 \times \frac{36}{5} = \frac{108}{5}$$

#

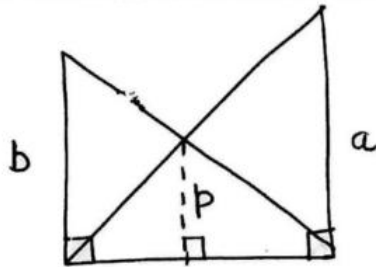

$$p = \frac{ab}{a+b}$$

#

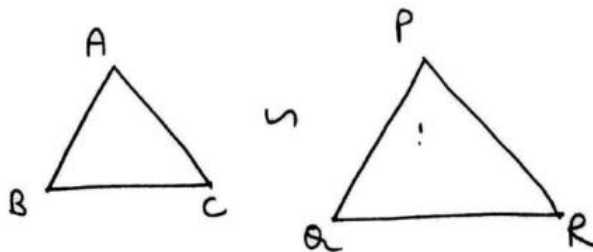

$$\frac{\text{Area } (\Delta ABC)}{\text{Area } (\Delta PQR)} = \left(\frac{AB}{PQ}\right)^2 = \left(\frac{BC}{QR}\right)^2 = \left(\frac{AC}{PR}\right)^2 = \left(\frac{\text{P.of } \Delta ABC}{\text{P.of } \Delta PQR}\right)^2 =$$

$$\left(\frac{\text{Median / Angle bisector / Altitude of } \Delta ABC}{\text{Median / Angle bisector / Altitude of } \Delta PQR}\right)^2$$

GoCareer.in

48) In a ΔABC a line DE is drawn parallel to BC in such a way that it divide the Δ in two equal areas
find $\frac{AD}{DB}$

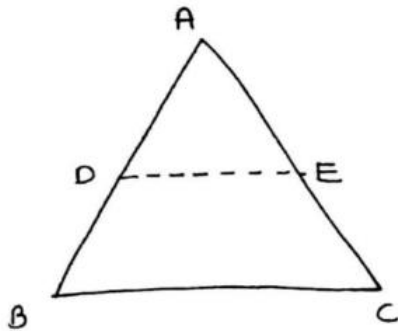

Area	Small Δ (ΔADE)	Larger Δ (ΔABC)
	1	2
side	1	$\sqrt{2}$
	$AD = 1$	$AB = \sqrt{2}$
		$DB = \sqrt{2} - 1$

$$\frac{AD}{DB} = \frac{1}{\sqrt{2}-1}$$

49) In ΔABC a line DE is drawn parallel to BC in such a way that

$$\text{Area } \Delta ADE : \text{Area } \square BCED = 16 : 33$$

$$\frac{AD}{DB} = ?$$

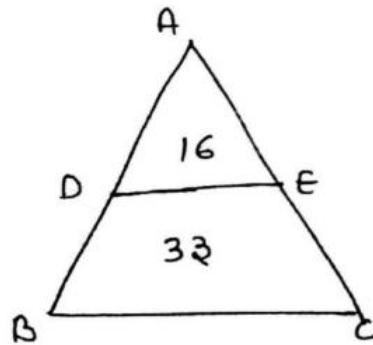

	ΔADE	ΔABC
Area	16	49
side	4	7
	\downarrow	\downarrow
	AD	AB

$$DB = 7 - 4 = 3$$

$$\frac{AD}{DB} = \frac{4}{3}$$

50)

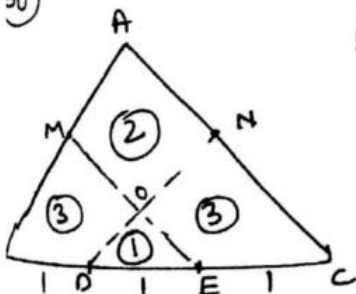

in ΔABC , D & E are two points on BC such that they trisect the line BC

$$DN \parallel AB$$

$$EM \parallel AC$$

$$\frac{\text{Area } \Delta DDE + \text{Area } \square AMON}{\text{Area } \Delta ABC} =$$

$$\text{Ar } \Delta DNC = 4$$

$$\text{Ar } \Delta DDE = 1$$

$$\text{Ar } \Delta EMB = 4$$

$$\frac{1+2}{9} = \frac{1}{3}$$

Ans

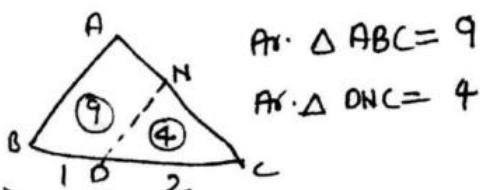

$$\text{Ar } \Delta ABC = 9$$

$$\text{Ar } \Delta DNC = 4$$

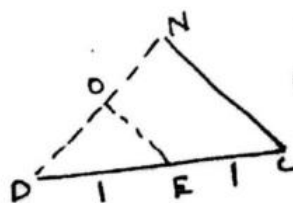

CLASS
52

GoCareer.in

⊕

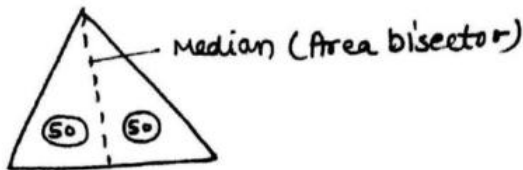

51) In $\triangle ABC$, D is the mid point of BC. And E is the mid point of line ~~AB~~ AD.

Ar. $\triangle ABE$: Ar $\triangle ABC$ = ?

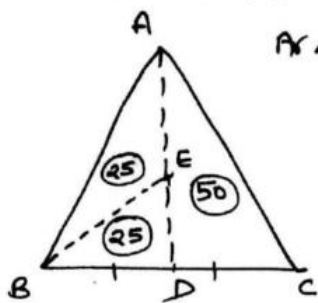

Ar $\triangle ABC$ = 100 (let)

$$\frac{\text{Ar. } \triangle ABE}{\text{Ar } \triangle ABC} = \frac{25}{100} = \frac{1}{4}$$

52) ABCD is a \square . E & F are mid point of DC & BC. find the ratio of area of shaded portion to the area of unshaded portion.

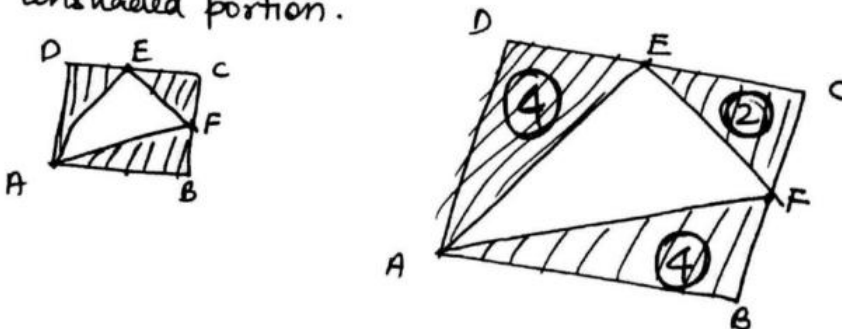

16 इसलिए लेते हैं क्योंकि बार-बार Half करना पड़ रहा है, so fraction ना बने।

Let area of $\square ABCD$ = 16

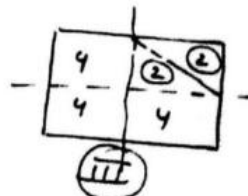
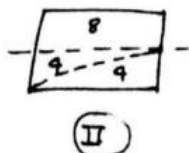
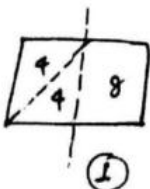

$$\frac{\text{Area shaded}}{\text{unshaded}} = \frac{10}{6} = \frac{5}{3} \quad \underline{\text{Ans.}}$$

Rakesh Yadav

116 Advance Maths (Volume-2)

53) A, B, C, D are the vertex of a ll gm. P, Q, R, S are the mid point of AB, BC, CD & DA. T is the mid point of line PS.

Area Δ ATS : Area Δ PTQ

Let area \square ABCD = 16

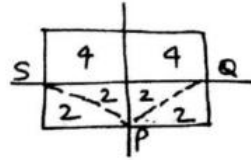
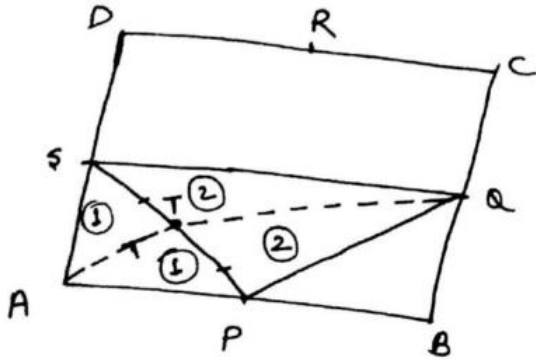

Ar Δ SPQ = 4

$$\frac{\text{Ar. } \Delta \text{ ATS}}{\text{Ar. } \Delta \text{ PTQ}} = \frac{1}{2} \quad \underline{\text{Ans}}$$

54)

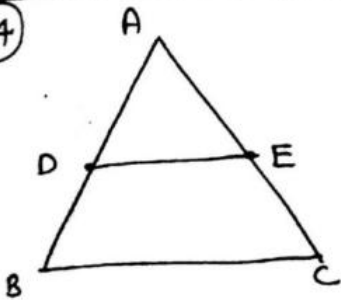

D & E are mid points.

find area Δ ADE : Area Δ ABC

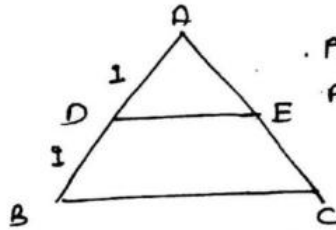

$$\frac{\text{Ar. } \Delta \text{ ADE}}{\text{Ar. } \Delta \text{ ABC}} = \frac{(1)^2}{(2)^2} = \frac{1}{4}$$

55)

A, B, C, D are the vertex of a ll gm. P, Q, R, S are the mid points of AB, BC, CD, DA. find the area of shaded portion : unshaded portion.

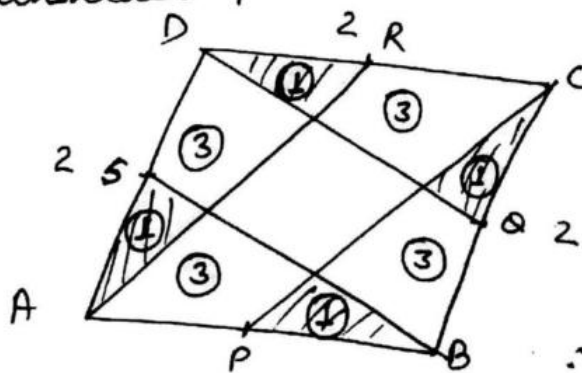
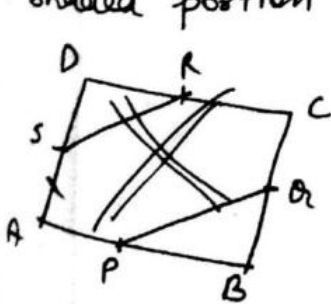

\therefore Ar ABCD = 20

$$\frac{\text{shaded}}{\text{unshaded}} = \frac{4}{16} = 1:4$$

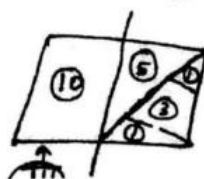
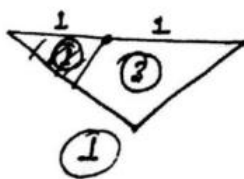
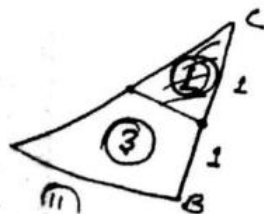

56) A, B, C, D are the vertex of a \square ABCD. P, Q, R, S are the mid points of line AB, BC, CD & DA. M, N, O, E are the mid points of PQ, QR, RS & SP.

Area of $\triangle SON$: Area of \square ABCD

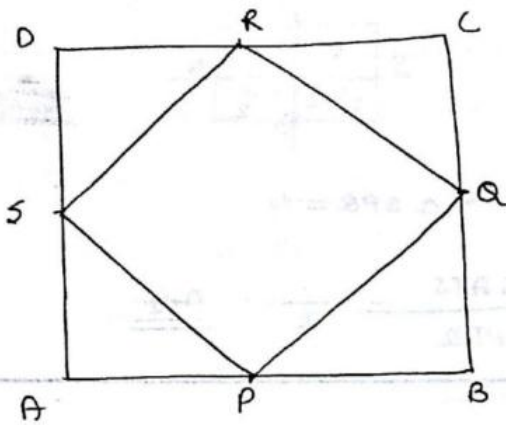

Area \square ABCD = 16 (let)

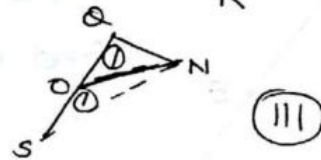
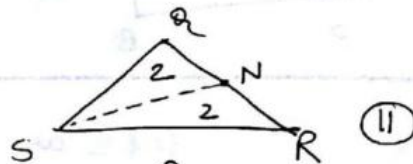
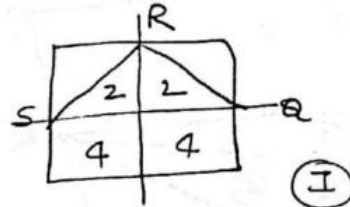

$$\frac{\text{Ar } \triangle SON}{\text{Ar } \square ABCD} = \frac{1}{16}$$

#

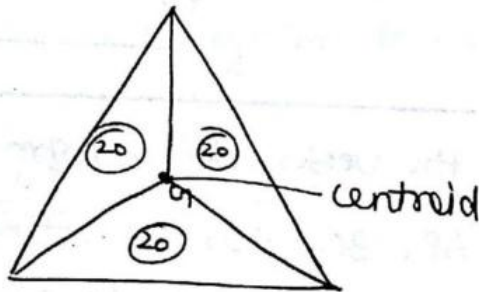
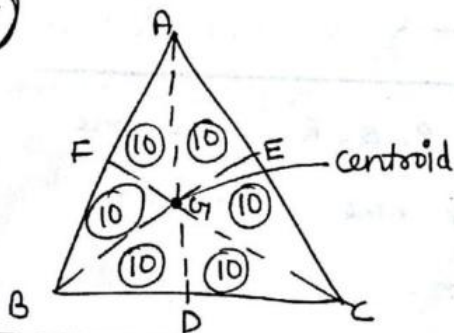

57) In a \triangle ABC BD & CE are two medians, cut each other at point O.

(A) Area \triangle DOE : Area \triangle BOC

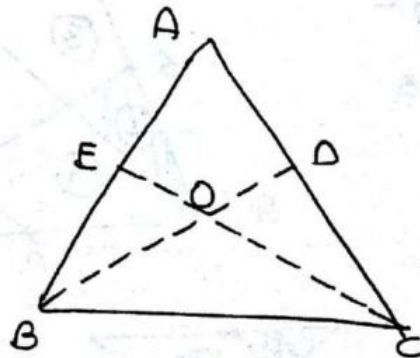
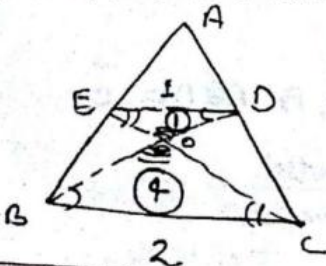

$$\frac{\text{Area } \triangle DOE}{\text{Area } \triangle ABC} = \frac{1}{4+4+4} = \frac{1}{12}$$

(B) Area $\triangle DOE$: Area of $\triangle DOC$

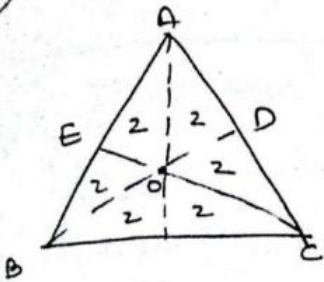

1:2

GoCareer.in

(C) Area $\triangle DOE$: Area of $\triangle ADE$.

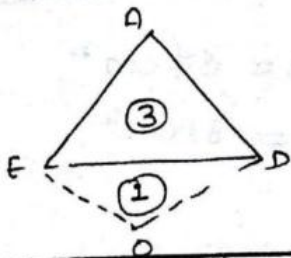

$$\frac{\text{Area } \triangle DOE}{\text{Area } \triangle ADE} = \frac{1}{3}$$

(#)

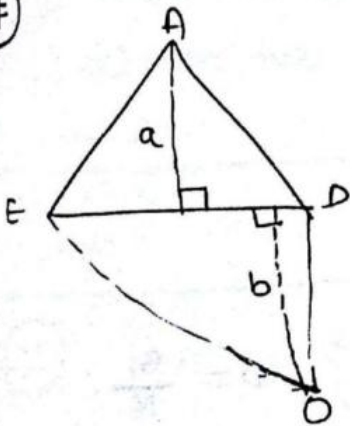

$$\frac{\text{Ar. } \triangle AED}{\text{Ar. } \triangle EOD} = \frac{\frac{1}{2} \times ED \times a}{\frac{1}{2} \times ED \times b} = \boxed{\frac{a}{b}}$$

The ratio of area of two Δ 's w/c are based on the same base is equal to the ratio of length of their altitudes drawn on the same base.

(58) In a $\triangle ABC$, BD & CE are two medians w/c intersect each other on O. The line AO intersect the line ED at M. $AM : MO = ?$

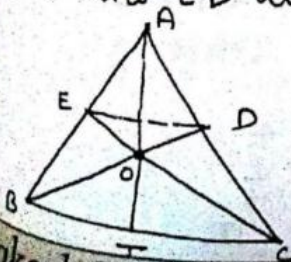

$\therefore OT \rightarrow 2$ let $\therefore AO : OT = 2 : 1$

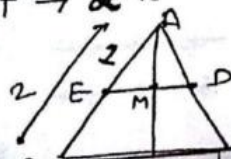

$AT \rightarrow 6$
 $AM = 3$
 $MO = 1$
 $\frac{AM}{MO} = \frac{3}{1}$

अगर दो Δ similar हैं तो उनकी sides के ratio के बराबर

$$\therefore \frac{\text{Area } \triangle AED}{\text{Area } \triangle EOD} = \frac{3}{1}$$

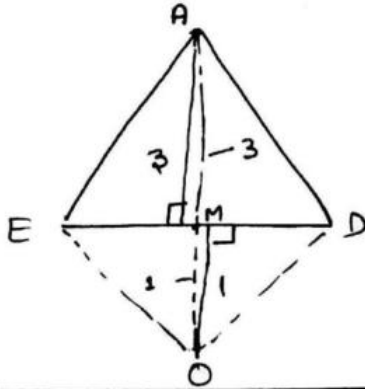

GoCareer.in

(59)

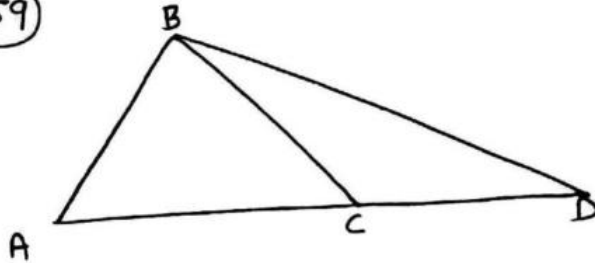

$$\begin{aligned} \text{Area } \triangle ACB &= 64 \text{ cm}^2 \\ \text{Area } \triangle BCD &= 81 \text{ cm}^2 \\ AC &= 4 \\ CD &= ? \end{aligned}$$

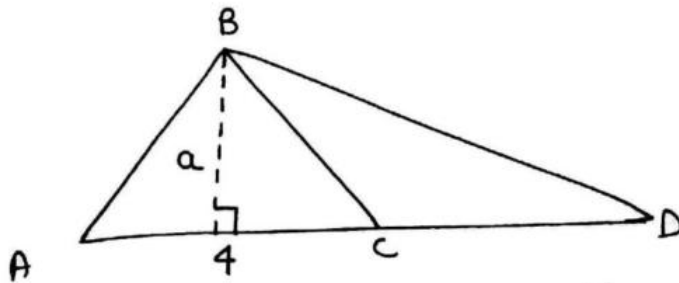

$$\begin{aligned} \text{Ar } \triangle ABC &= \frac{1}{2} \times AC \times h \\ \text{Ar } \triangle BCD &= \frac{1}{2} \times CD \times h \end{aligned} \Rightarrow \frac{64}{81} = \frac{4}{CD} \quad CD = \frac{81}{16}$$

⊗ If two Δ 's have a common vertex and are based on a same straight line, have the area in the ratio as the length of their bases.

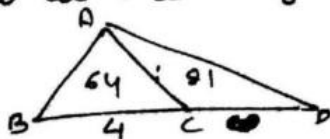

$4 \rightarrow 64$	$64 \rightarrow 4$
$16 \rightarrow 81$	$1 \rightarrow \frac{1}{16}$
	$81 \rightarrow \frac{81}{16}$

#

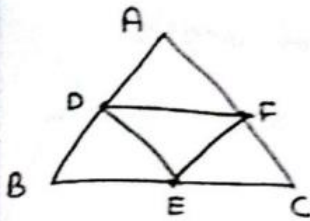

Ar. $\triangle DEF$: Ar. $\triangle ABC$
1 : 4

D, E, F are mid points.

- 60) In $\triangle ABC$, the length BC extended to point P.
D, F are the mid points of line AB & AC.
Ar $\triangle DFP$: Ar $\triangle ABC = ?$

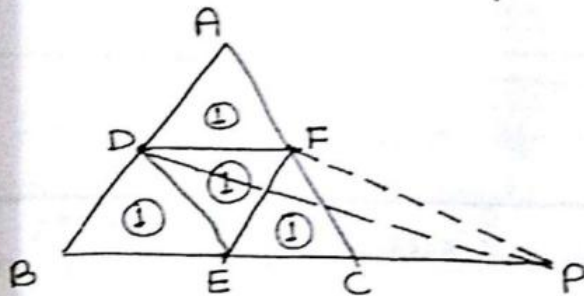

1 : 4

Ar $\triangle DFE = \text{Ar } \triangle DFP$

$\therefore \text{Ar } \triangle DFP = 1$

Ar $\triangle ABC = 4$

$\therefore \text{Ar } \triangle DFP : \text{Ar } \triangle ABC = 1 : 4$

- # When two \triangle 's have the same base and are present between two parallel lines, then their area will be same.

CLASS
53

CIRCLE

#

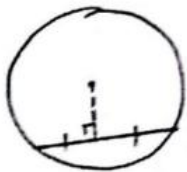

- 61) find the \perp distance b/w two parallel chords of length 6cm and 8cm w/c are on the opposite direction on the centre of circle of radius 5cm.

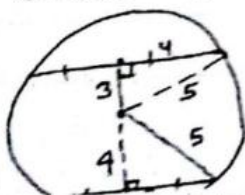

62) find the \perp distance b/w two \parallel chords of length 16 cm and 30 cm w/e are on the same side of the centre of the circle of radius 17 cm.

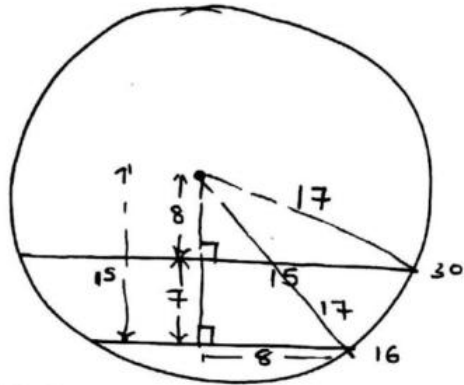

7 cm Ans

3) AB and AC are two chords of a circle of radius 5 cm

$AB = AC = 6 \text{ cm}$

$r = 5 \text{ cm}$

$BC = ?$

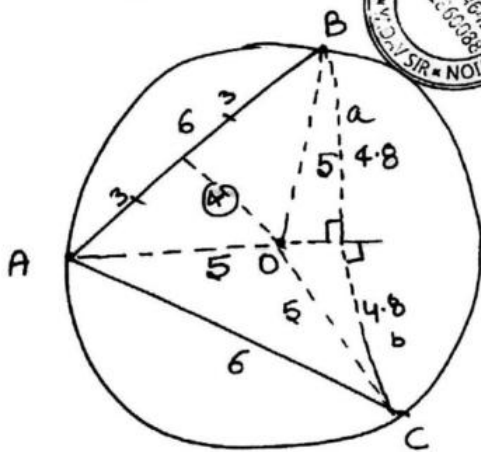

$BC = 4.8 + 4.8 = 9.6$

$\Delta AOB =$ obtuse isosceles Δ

$\text{Ar} \Delta AOB =$

$\frac{1}{2} \times 6 \times 4 = \frac{1}{2} \times 5 \times a$

$a = 4.8$

similarly $b = 4.8$

$BC = a + b = 9.6$

Δ obtuse या acute
कैसी भी बन सकती है

62

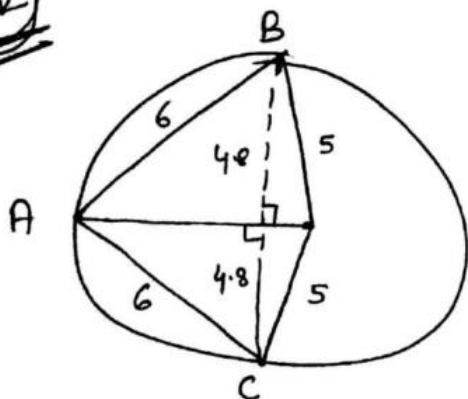

#

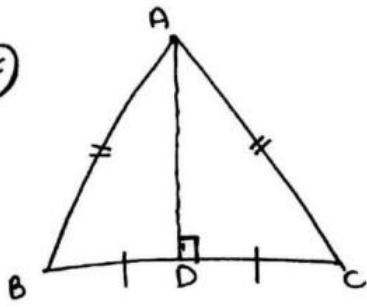

In an isosceles Δ , if a \perp is drawn from the common vertex of two equal sides on the opposite side, then it will bisect the opposite side.

$AB = AC$ (common vertex = A)

$AD \perp BC$

\therefore $BD = DC$

64) $2a, 2b$ are the length of two chords w/c intersects each other at right angle. find the radius of the circle and the distance from their intersecting point to the centre of circle is $c, c < \text{radius}$.

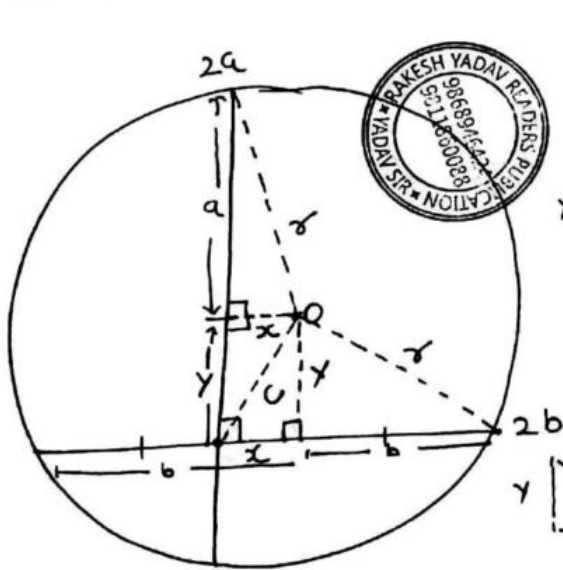

$\begin{matrix} r \\ a \\ x \end{matrix} \rightarrow x^2 = r^2 - a^2$

$\begin{matrix} r \\ c \\ y \end{matrix} \rightarrow y^2 = c^2 - x^2$
 $y^2 = c^2 - (r^2 - a^2)$

$y^2 = c^2 - r^2 + a^2$

$\begin{matrix} r \\ b \\ y \end{matrix} \rightarrow r^2 = y^2 + b^2$
 $r^2 = c^2 - r^2 + a^2 + b^2$

$r^2 = \frac{a^2 + b^2 + c^2}{2}$

$r = \sqrt{\frac{a^2 + b^2 + c^2}{2}}$

GoCareer.in

#

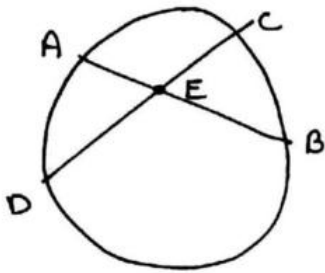

$$AE \times EB = CE \times ED$$

65) AB and CD are two chords of a circle w/c intersects each other at right angle at E

$$AE = 6, EB = 2, CE = 3, r = ?$$

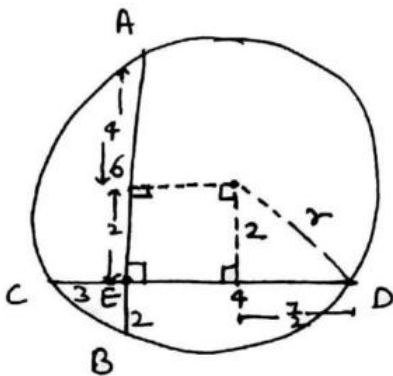

$$6 \times 2 = 3 \times ED$$

$$ED = 4$$

$$r^2 = 4 + \frac{49}{4}$$

$$r^2 = \frac{16 + 49}{4}$$

$$r^2 = \frac{65}{4}$$

$$r = \frac{\sqrt{65}}{2}$$

#

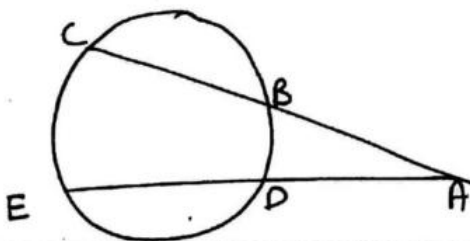

$$AB \times AC = AD \times AE$$

66

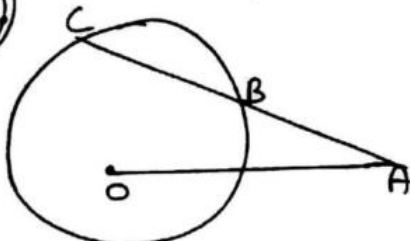

$$AB = 9, BC = 7$$

$$AO = 13, r = ?$$

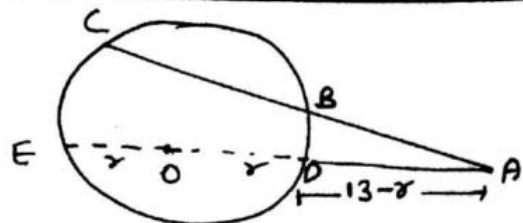

$$AD = 13 - r$$

$$AE = 13 + r$$

$$9 \times 16 = (13 - x)(13 + x)$$

$$144 = 169 - x^2$$

$$25 = x^2$$

$$x = 5$$

GoCareer.in

#

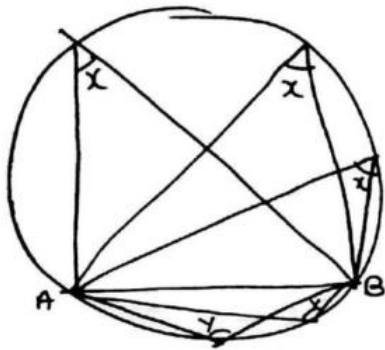

angle made by the ^{same} chord on the same side of the circle are equal.

#

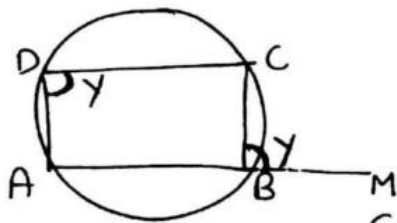

cyclic quadrilateral

$$A + C = 180$$

$$B + D = 180$$

External angle is equal to opposite internal angle.

$$\angle CBM = \angle CDA = y$$

67

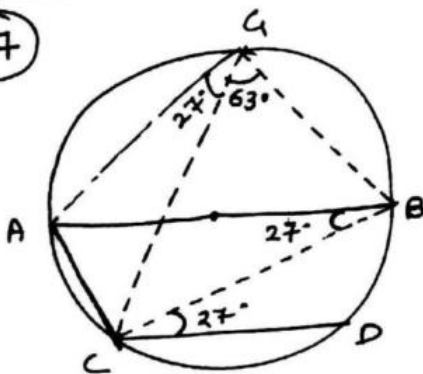

$AB \parallel CD$
 $\angle BCD = ?$

$AB \rightarrow$ diameter

angle made by

diameter = 90°

$$90 - 63 = 27$$

angle made by same chord AC

$$\therefore \angle ABC = 27^\circ$$

$AB \parallel CD$

$$\therefore \angle BCD = 27^\circ$$

68) $\angle BCD = ?$

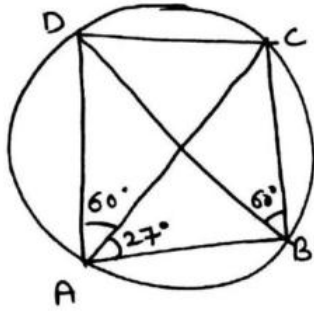

$\angle DBC = \angle DAC = 60^\circ$
(angle made by same chord DC)

$$A + C = 180^\circ$$

$$67 + C = 180^\circ$$

$$C = 93^\circ$$

69) In a ΔABC , the angle bisector of angle A, B & C intersect the circumcircle at D, E & F.

$$\angle A = 50^\circ$$

$$\angle EFC = 34^\circ$$

$$\angle FEB = ?$$

$$\angle FEC = ?$$

$$\angle AEC = ?$$

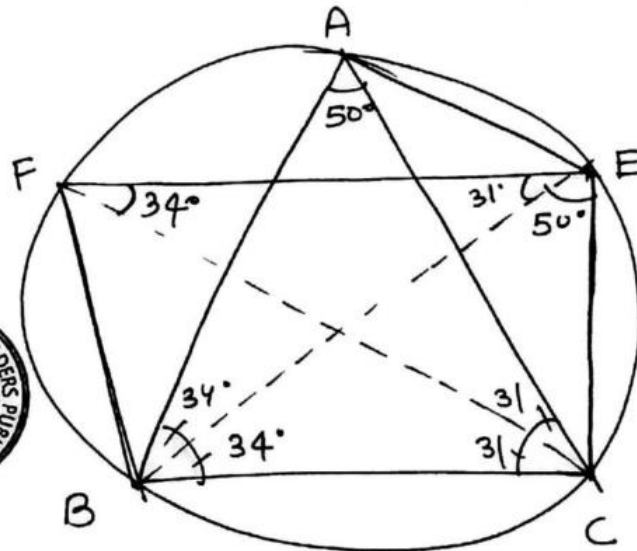

$\angle EFC = \angle EBC = 34^\circ$ (Angle made by same chord EC)

$$\angle B + \angle E = 180^\circ$$

$$68^\circ + \angle E = 180^\circ$$

$$\angle FEC = 112^\circ$$

$$\angle C = 62^\circ \quad (\because \angle A = 50^\circ, \angle B = 68^\circ)$$

$\angle FEB = \angle FCB = 31^\circ$ (Angle made by same chord FB)

$\angle BAC = \angle BEC = 50^\circ$ (" " " " " " BC)

Rakesh Yadav

CLASS
54

70) ACB and MNC are two secants of a circle cut at point C outside circle. AN is the diameter of the circle.

$\angle C = 28^\circ$

$\angle NAB = 35^\circ$

$\angle MBN = ?$

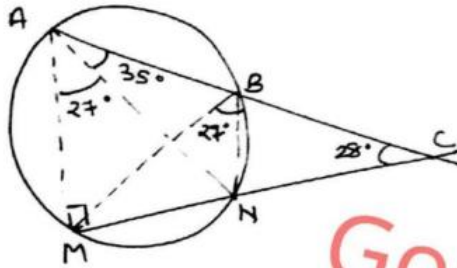

GoCareer.in

$AN \rightarrow$ diameter

$\angle AMC = 90^\circ$ (angle in the half circle)

$\angle MAN = 180^\circ - (90 + 28 + 35) = 27^\circ$

$\angle MBN = 27^\circ$ (Angle made by the same chord MN).

71

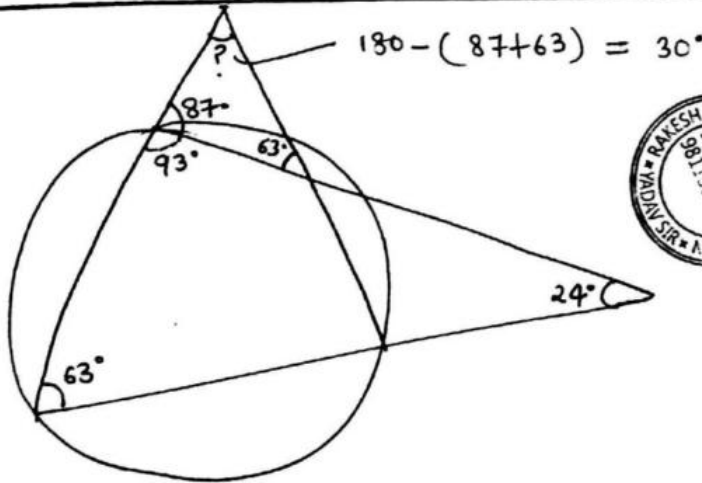

72

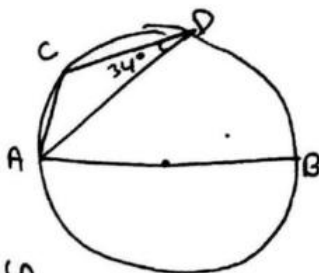

$CA = CD$
 $\angle OAB = ?$

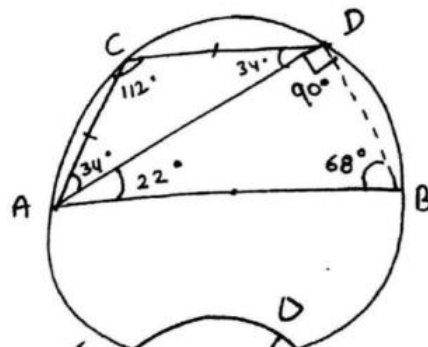

$\angle BCD = 20^\circ$
 $BC = OD$
and intersecting
straight line
at a point

73) AC & BC are the length of two chords, the line BA is produced to any point P & when line CP is joined it cuts the circle at T .

- $AC = BC$
- $CP = ?$
- $CT = 5$
- $BC = 8$

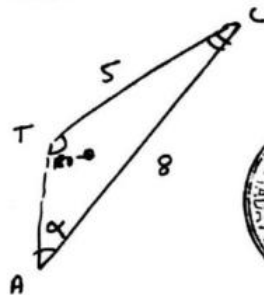
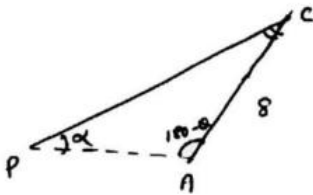
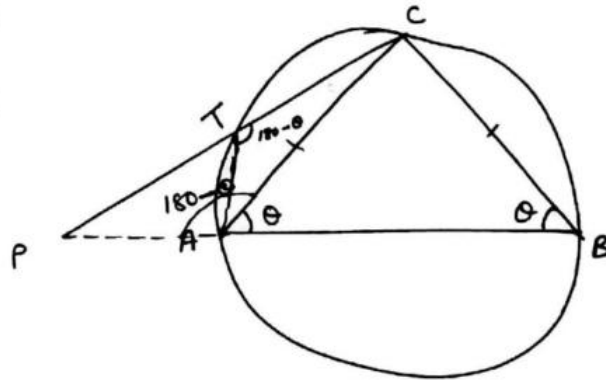

$$\frac{CP}{8} = ?$$

$$\therefore CP = \frac{64}{5} = 12.8$$

A circle of centre O . BOC is a \sphericalangle from a point D on the circle producing at C .

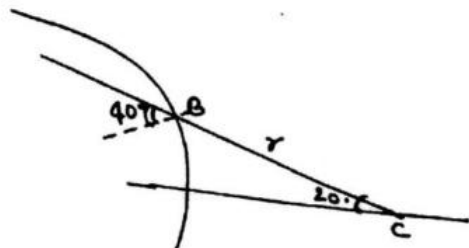

75) The bisector of angle $\angle A$ of a ΔABC cuts BC at D and the circumcircle of the Δ at E .

- $DE = 3$
- $AC = 4$
- $AD = 5$
- $AB = ?$

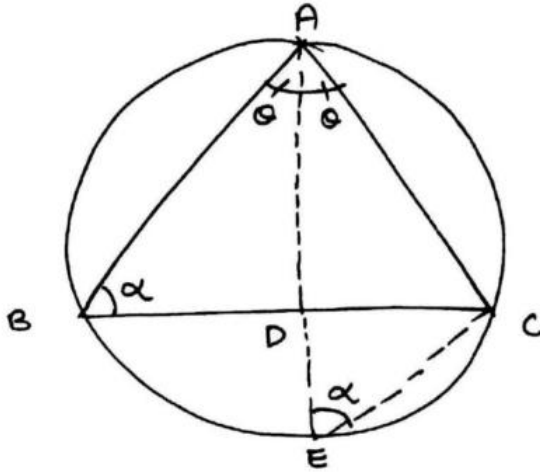

GoCareer.in

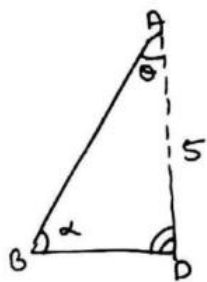

1155

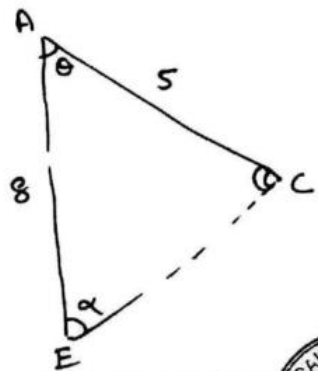

$$\frac{AB}{8} = \frac{5}{4}$$

$$AB = 10$$

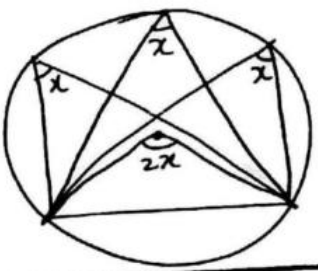

76) AB & CD are two chords of a circle w/c intersect each other at 90° . O is the centre of the circle.

- $\angle CAO = 32^\circ$
- $\angle BCD = ?$

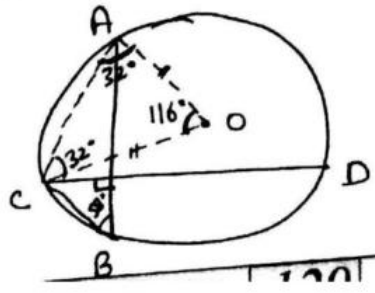

$\angle CBA = 58^\circ$
 (Half of the angle made by the same chord AC at centre)
 $\angle BCD = 180 - (90 + 58)$

- (77) AB & AC are two chords of a circle of centre O. M & N are their mid points. The line OM and ON are extended w/c intersects the circumcircle at R & Y. S is a point on major arc RY.

$\angle A = 48^\circ$

$\angle RSY = ?$

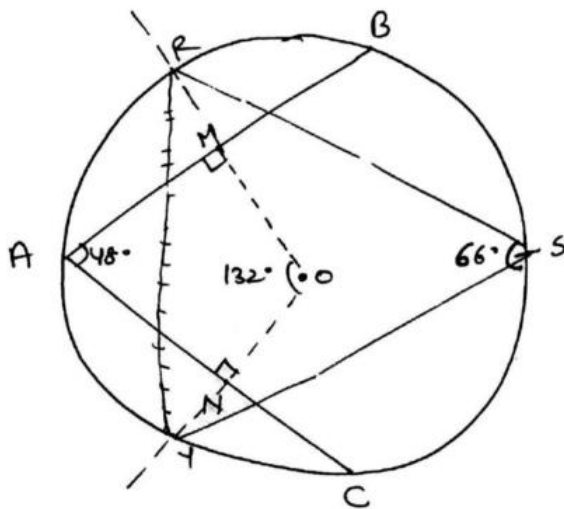

$\angle RSY = 66^\circ$

- (78) AB & CD are two chords of a circle w/c intersects each other at P.

$\angle AOC = 20^\circ$

$\angle APC = 42^\circ$

$\angle BOD = ?$

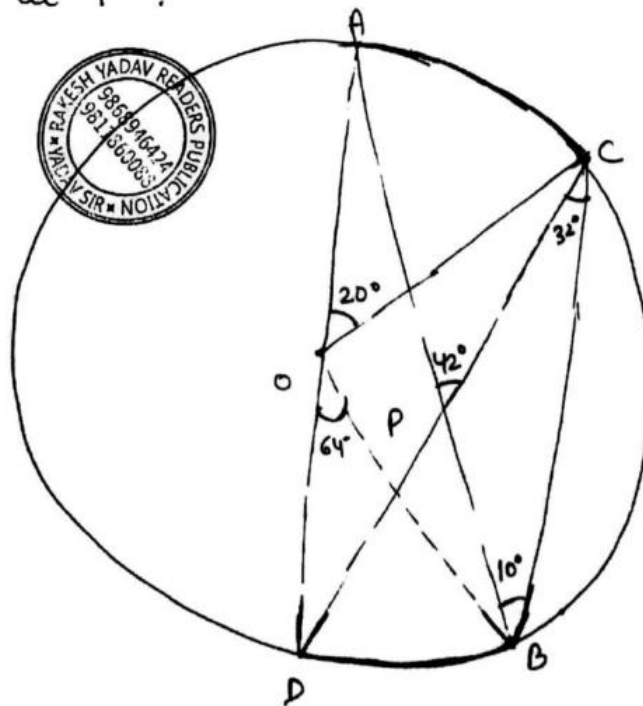

$\angle BOD = 64^\circ$

- 79) O and C are respectively orthocentre & circumcentre of an acute angle ΔPQR . The point P and O are joined and produced to meet the side QR at S
 $\angle QCR = 130^\circ$
 $\angle RPS = ?$
 $\angle PQS = 53^\circ$

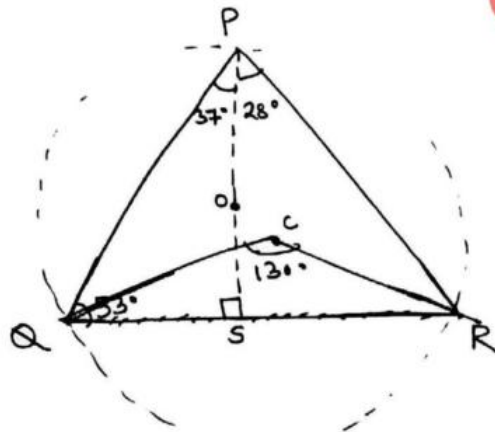

GoCareer.in



- 80) In ΔPQR , I & C are resp. incentre & circumcentre of the Δ . The line PI is extended w/c intersect the circumcircle at point D.

$\angle QCD = x^\circ$
 $\angle PQR = y^\circ$
 $\angle QID = z^\circ$
 $\frac{5x + 5y}{3z} = ?$

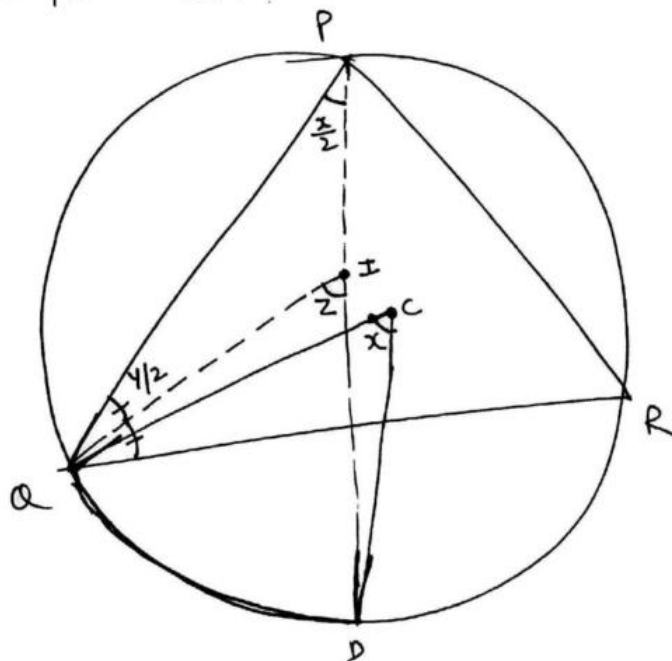

$z = \frac{x}{2} + \frac{y}{2}$

$2z = x + y$

$\frac{5x + 5y}{3z} = \frac{5(x+y)}{3z} = \frac{5 \times 2z}{3z} = \frac{10}{3} \underline{\underline{Ar}}$

81

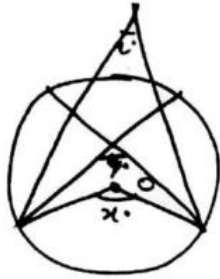

$$\frac{4y+4z}{3x}$$

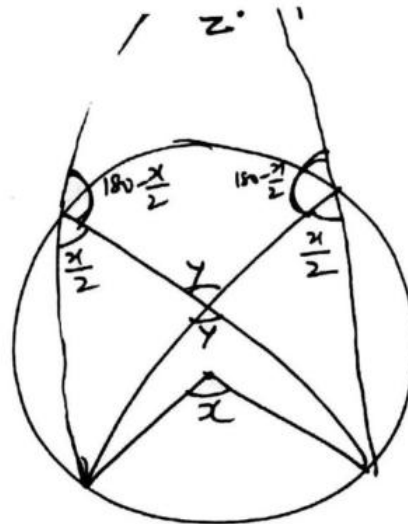

$$y+z+180-\frac{x}{2}+180-\frac{y}{2}+180-\frac{z}{2} = 360^\circ$$

$$y+z-x = 0$$

$$\boxed{x = y+z}$$

$$\frac{4(y+z)}{3x}$$

$$\frac{4x}{3x}$$

$$= \frac{4}{3} \text{ Ans.}$$

CLASS
55.

81

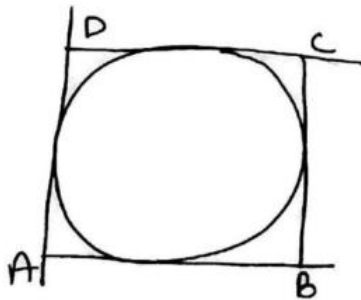

$$\boxed{AB+DC = AD+BC}$$

82

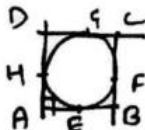

$$CG = 22$$

$$BC = 30$$

$$AB = 12$$

$$r = ?$$

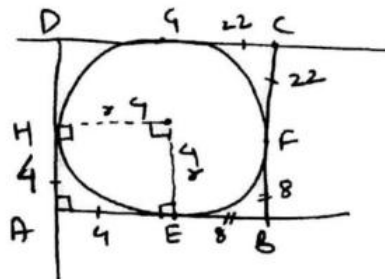

$$\boxed{r = 4} \text{ Ans}$$

Q3

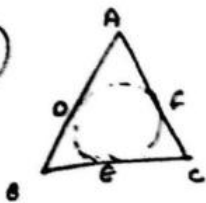

BE=1
CF=2
AD=3
what type
of Δ it is.

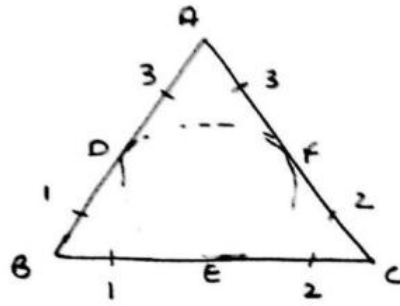

sides of $\Delta = 3, 4, 5$
So: ABC is right angle Δ .

TANGENTS

Q4

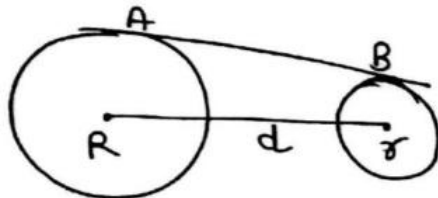

$$D.C.T (AB) = \sqrt{d^2 - (R-r)^2}$$

Q5

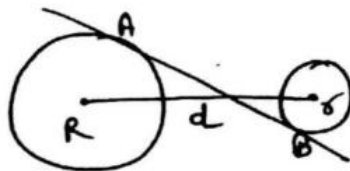

$$T.C.T = AB = \sqrt{d^2 - (R+r)^2}$$

GoCareer.in

Q6

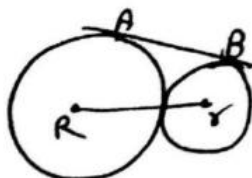

$$AB = 2\sqrt{Rr}$$

- (84) Find the area of the square formed by the common direct tangent of two circles of radii 9 cm and 4 cm which touch each other externally.

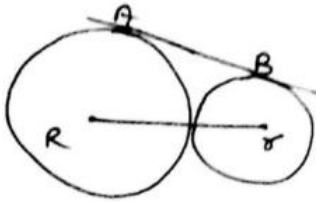

$$AB = 2\sqrt{9 \times 4} = 12$$

$$\text{Area of square of side } AB = 12^2 = 144 \text{ cm}^2$$

(85)

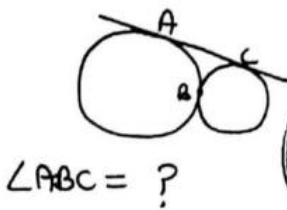

$\angle ABC = ?$

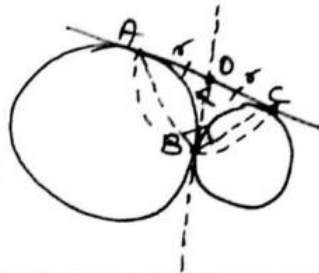

$\angle B = 90^\circ$

- (86) Two circles of radii a cm and b cm touch each other externally. Another circle of radius c touches both these circles externally & also touches their direct common tangent. Find the relation between a , b and c .

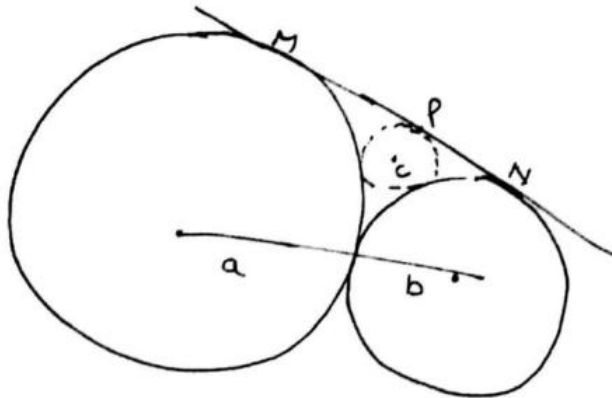

$$\begin{array}{ccc} MN & MP & PN \\ 2\sqrt{ab} & 2\sqrt{ac} & 2\sqrt{bc} \end{array}$$

$$MN = MP + PN$$

$$2\sqrt{ab} = 2\sqrt{ac} + 2\sqrt{bc}$$

$$\frac{2\sqrt{ab}}{2\sqrt{abc}} = \frac{2\sqrt{ac}}{2\sqrt{abc}} + \frac{2\sqrt{bc}}{2\sqrt{abc}}$$

$$\boxed{\frac{1}{\sqrt{c}} = \frac{1}{\sqrt{b}} + \frac{1}{\sqrt{a}}}$$

87) Two circles of radius 4 cm & 3 cm touch each other internally. find the length of largest chord of the larger circle w/c is just outside the smaller circle.

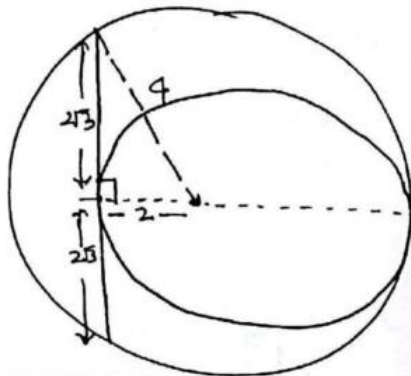

$$\sqrt{4^2 - 2^2} = \sqrt{12} = 2\sqrt{3}$$

$$2\sqrt{3} + 2\sqrt{3} = 4\sqrt{3} \quad \underline{\text{Ans}}$$

88) ~~Find~~ AB and AC are the length of two tangents from a circle of radius 5 cm. find the length (minimum) of another tangent w/c intersects AB and AC at M & N.

MN = ?

r = 5

AB = 12

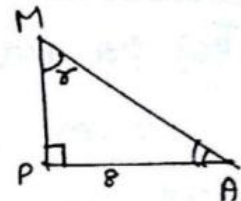
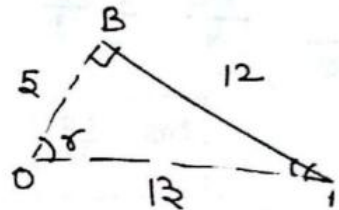
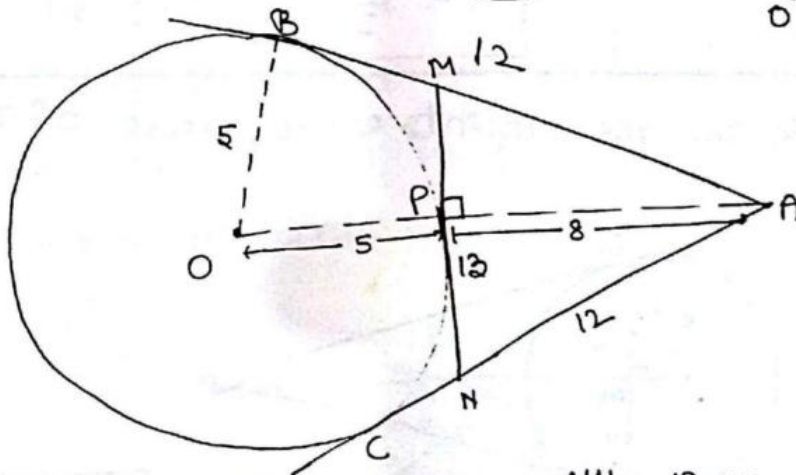

$$\frac{MP}{5} = \frac{8}{12}$$

$$MP = \frac{10}{3}$$

$$MN = \frac{10}{3} + \frac{10}{3} = \frac{20}{3}$$

89) AB & AC are two tangents of circle of radius 5 cm.

r = 5 cm

AB = ?

AO = ?

BC = 8

GoCareer.in

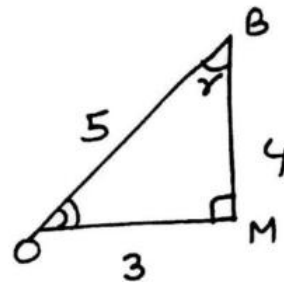
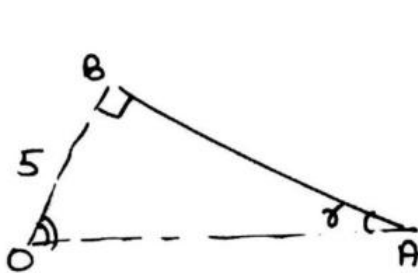
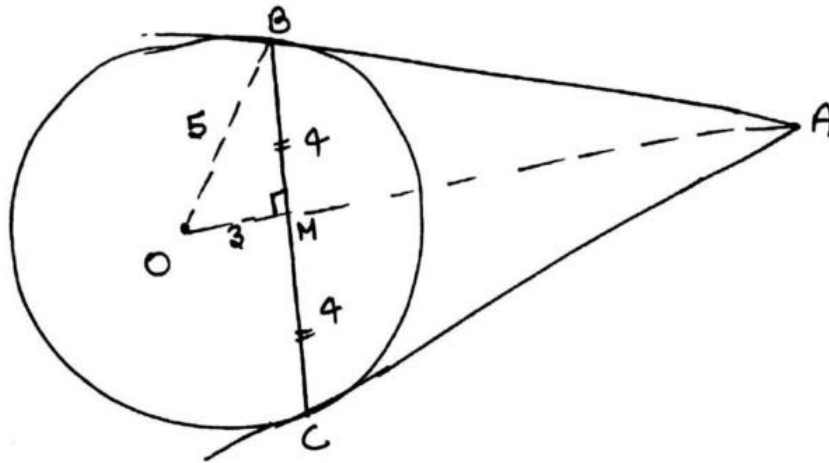

$$\frac{AB}{4} = \frac{5}{3}$$

$$AB = \frac{20}{3}$$

$$\frac{OA}{5} = \frac{5}{3}$$

$$OA = \frac{25}{3}$$

90) PA and PR are the tangents of a circle of radius

r cm

$$QR = 2a$$

$$PA = ?$$

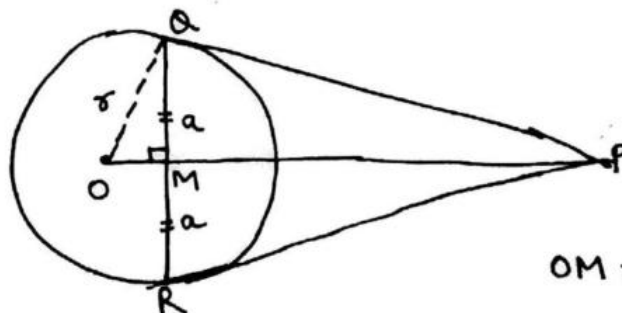

$$OM = \sqrt{r^2 - a^2}$$

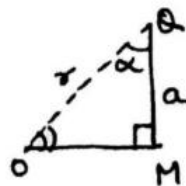
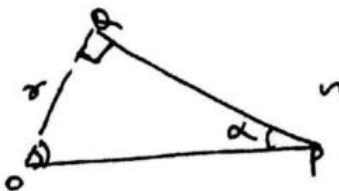

$$\frac{PA}{a} = \frac{r}{\sqrt{r^2 - a^2}}$$

$$PA = \frac{ar}{\sqrt{r^2 - a^2}}$$

Ans.

91) AB and AC are two tangents of a circle. R is a point on minor arc BC

$\angle BRC = 115^\circ$

$\angle A = ?$

GoCareer.in

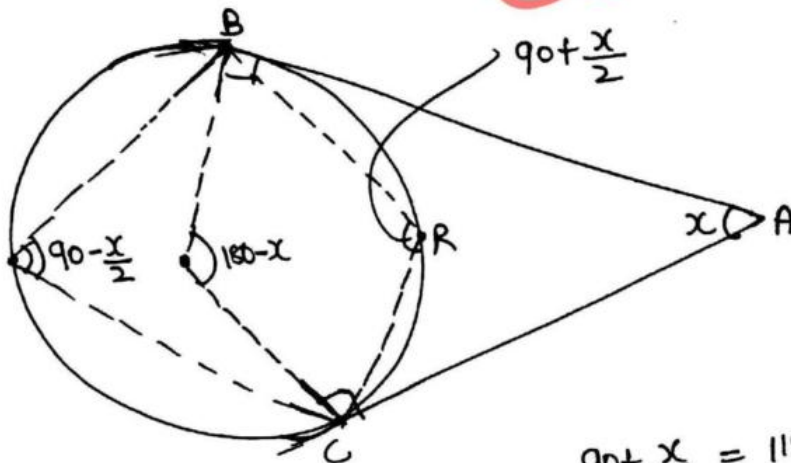

$\angle BRC = 90 + \frac{x}{2}$

$90 + \frac{x}{2} = 115$

$\frac{x}{2} = 25$

$x = 50^\circ$

92) AB and AC are two tangents of a circle. O is the center of the circle. MN is a tangent on the circle w/c intersects AB & AC at M & N. The tangent MN does not touch the circle at the point where the line OA intersects the circle.

$\angle A = 34^\circ$

$\angle MON = ?$

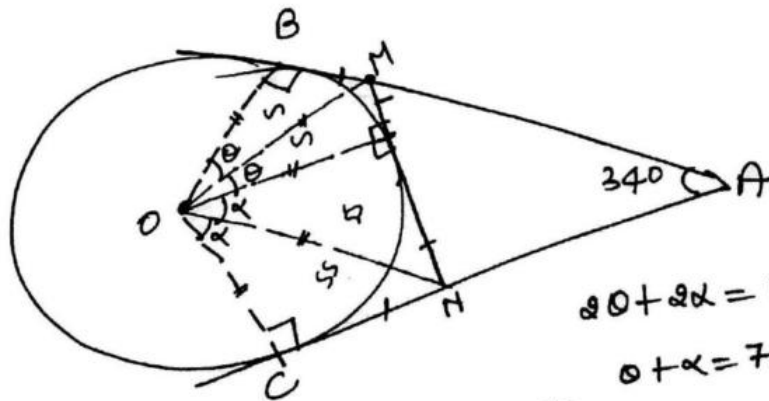

$20 + 2\alpha = 146^\circ$

$0 + \alpha = 73^\circ$

$\angle MON = 73^\circ$

93

AB = ?

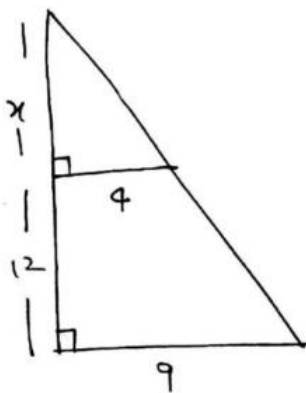
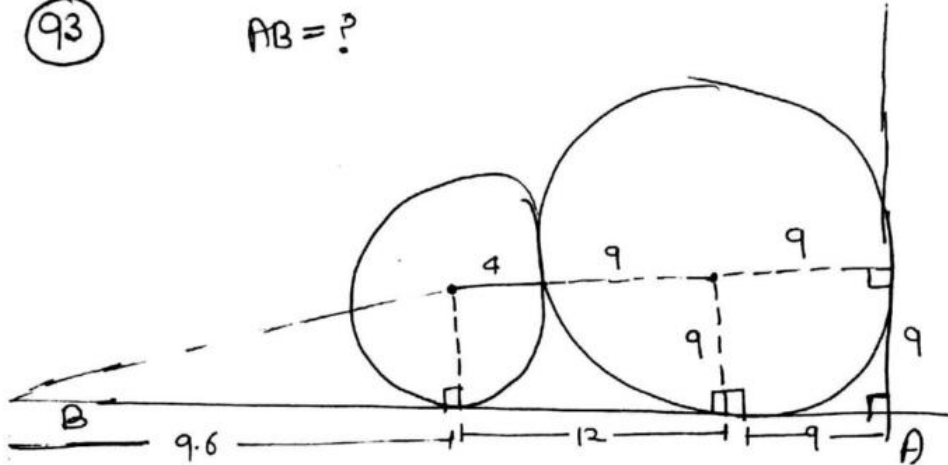

$$\frac{x}{x+12} = \frac{4}{9}$$

$$9x = 4x + 48$$

$$5x = 48$$

$$x = \frac{48}{5} = 9.6 \text{ cm}$$



$$AB = 9.6 + 12 + 9 = 30.6 \text{ cm}$$

94

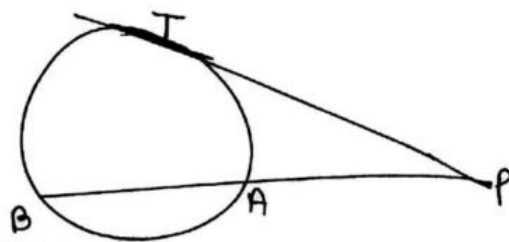

$$PT^2 = PA \times PB$$

94

In an isosceles ΔABC a circle goes through from vertex B and touches the mid point of line AC and intersects the line AB at M.

$$AB = AC$$

$$AM : MB = ?$$

50Career.in

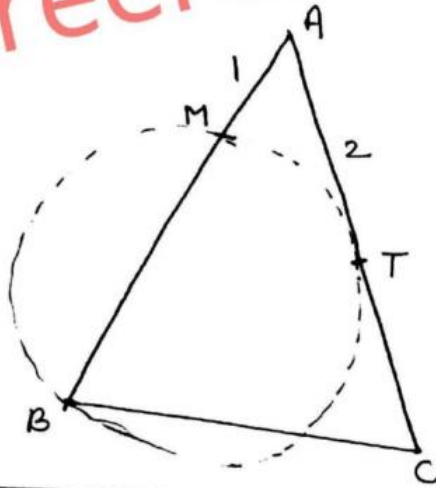

$$AB = AC = 4 \text{ (AM)}$$

$$AT^2 = AM \times AB$$

$$AM = 1$$

$$AM : MB$$

$$1 : 3$$

95

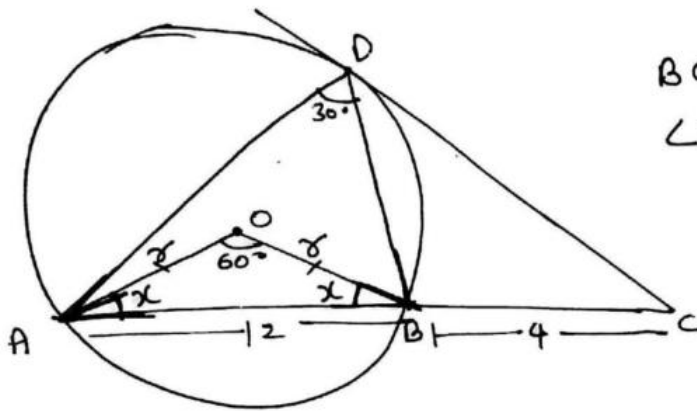

$$BC = 4$$

$$\angle APB = 30^\circ$$

$$r = 12$$

$$CD = ?$$

$$x + x + 60 = 180$$

$$x = 60^\circ$$

AOB is equilateral.



$$CD^2 = CB \times CA$$

$$CD^2 = 4 \times 16 = 64$$

$$CD = \sqrt{64}$$

$$CD = 8 \text{ cm}$$

#

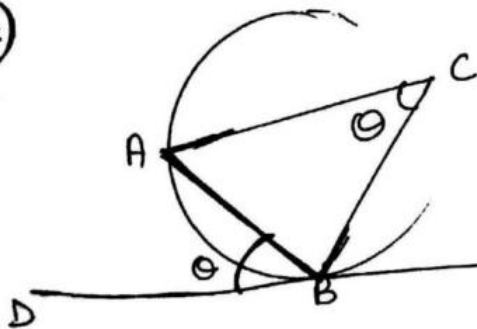

if angle θ is made from chord AB and tangent BD then the angle made by the chord AB in any part of the circle will be equal to θ .

96

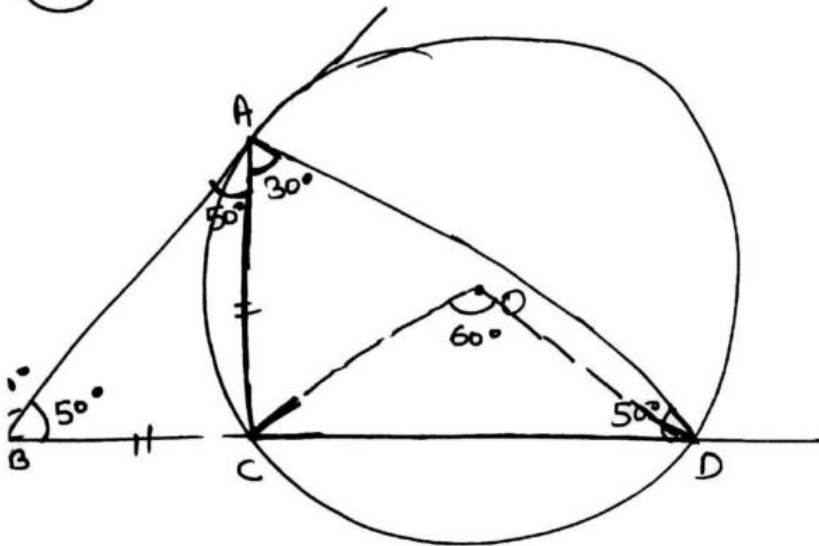

$BC = CA$
 $\angle COD = ?$

ΔABD
 $\angle B = 50, \angle D = 50$
 $\angle BAC = 50$
 $\therefore \angle CAD = 30$

97) A, B, C are three points on a circle. A tangent touches the circle at A and intersects the extended part of line BC at T. Find the central angle made by chord BC.

$\angle ATC = 44^\circ$
 $\angle CAT = 40^\circ$

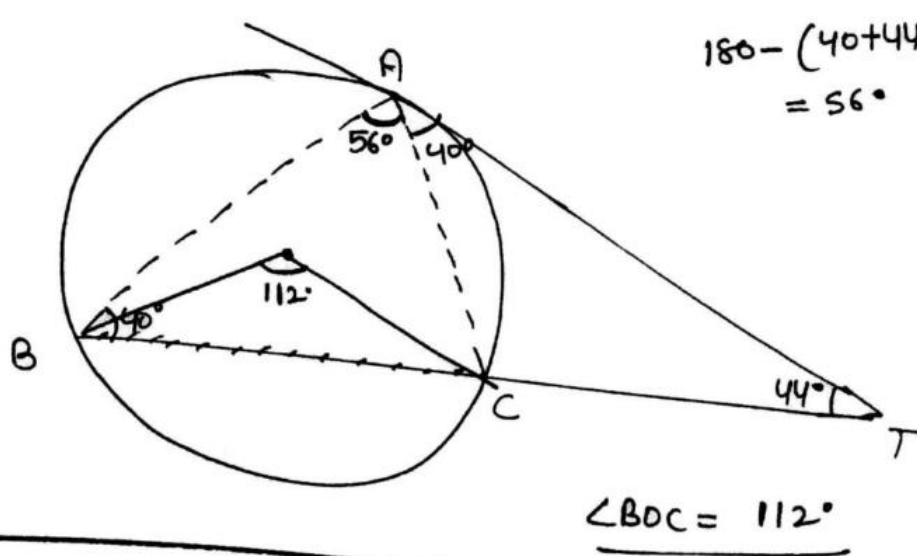

$180 - (40 + 44 + 40)$
 $= 56^\circ$

$\angle BOC = 112^\circ$

CLASS
56

98

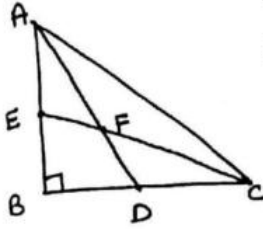

D is the mid point of BC

E is the midpoint of AB

find Ar. $\triangle AFC$: Ar $\square BDFE$.

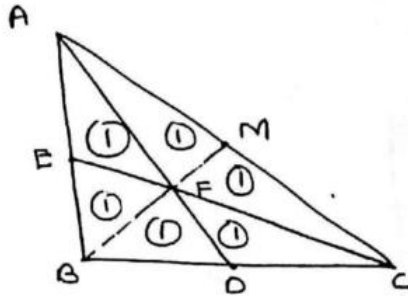

$$\frac{2}{2} = 1:1$$

99

In a $\triangle ABC$, $\angle A = 90^\circ$, BL and CN are two medians

$$BC = 5$$

$$BL = \frac{3\sqrt{5}}{2}$$

$$CN = ?$$

#

$$4(BL^2 + CN^2) = 5(BC)^2$$

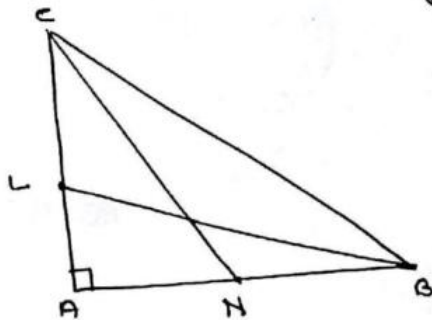

$$4 \left(\left(\frac{3\sqrt{5}}{2} \right)^2 + (CN)^2 \right) = 5 \times 25$$

$$4 \left(\frac{45}{4} + CN^2 \right) = 125$$

$$45 + 4CN^2 = 125$$

$$4CN^2 = 80$$

$$CN^2 = 20$$

$$CN = 2\sqrt{5}$$

GoCareer.ir

#

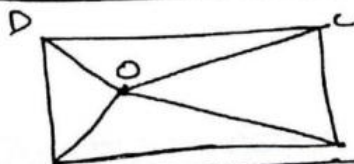

$$OD^2 + OB^2 = OA^2 + OC^2$$

(100) The bisector of $\angle A$ of a ΔABC intersects the side BC at D and meets the circumference of the ΔABC at E .

$AB \times AC + DE \times AE = ?$

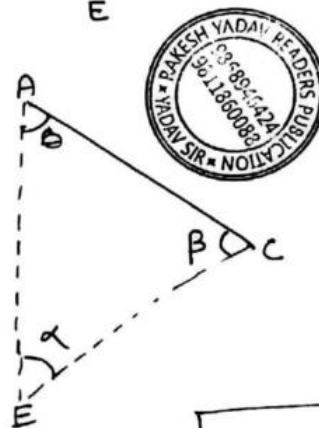
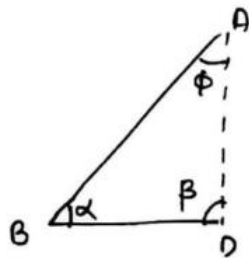
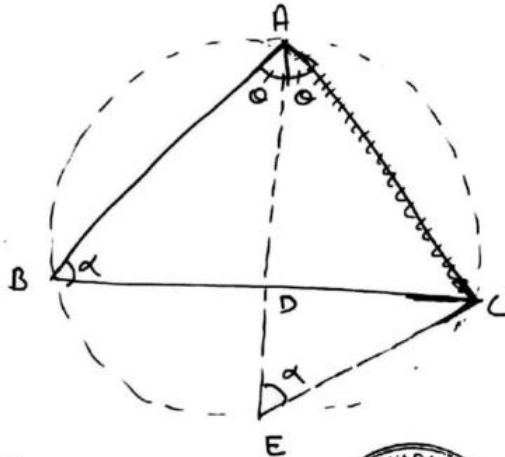

$$\frac{AB}{AE} = \frac{AD}{AC}$$

$$AB \times AC = (AE - DE) \times AE$$

$$= AE^2 - AE \times DE$$

$AB \times AC + AE \times DE = AE^2$

Ans.

(101) Three circles of radii touch each other externally and the distance b/w their centres is 5cm, 6cm & 7cm. find the radius of all the centres.

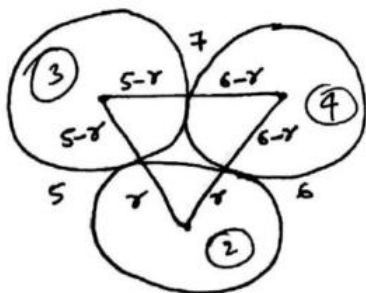

$$5 - r + 6 - r = 7$$

$$-2r = -4$$

$r = 2$

$$6 - 2 = 4$$

$$5 - 2 = 3$$

Ans.

102) A square is inscribed in a quarter circle in such a manner that ~~two~~ 2 vertex at equal distance from center while the other 2 vertices lies on the circular arc. If the square has side of the length x cm. find the radius of the circle.

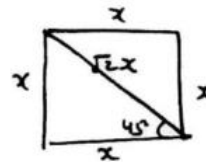
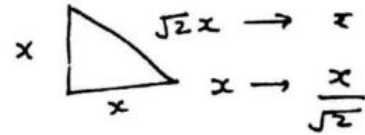
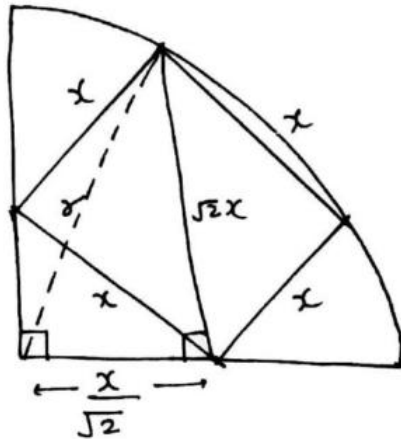

$$r^2 = \frac{x^2}{2} + 2x^2$$

$$r^2 = \frac{5x^2}{2}$$

$$r = \sqrt{\frac{5}{2}} x$$



103) In a ΔABC , D & E are two points on AC & BC

$DE = 18$

$CE = 5$

$\angle DEC = 90^\circ$

$\tan \angle ABC = 3.6$

$AC : CD = ?$

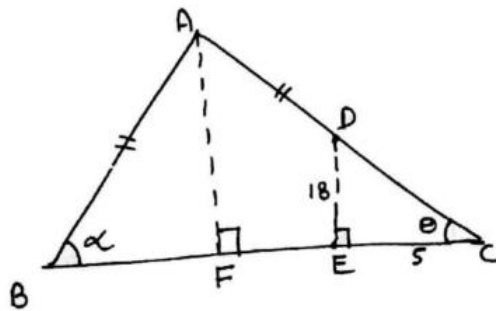

$$\tan \theta = \frac{P}{B} = \frac{18}{5} = 3.6$$

$$\tan \alpha = 3.6$$

$$\tan \theta = \tan \alpha \Rightarrow \theta = \alpha$$

$\therefore AB = AC$

$BF = FC$

$FC = \frac{BC}{2}$

$\Delta AFC \sim \Delta DEC$

$$\frac{CD}{CA} = \frac{CE}{CF}$$

$$\frac{CD}{CA} = \frac{2CE}{BC}$$

$CA : CD =$

$BC : 2CE$

- (A) $BC : 2CE$
- (B) $2CE : BC$
- (C) $2BC : CE$
- (D) $CE : 2BC$

104) In a ΔABC , D is a point on line BC and E is a point on line AD in such a way -

$$AD \perp BC$$

$$AE : ED = 5 : 1$$

$$\angle BAD = 30^\circ$$

$$\tan \angle ACB = 6 \tan \angle PBE$$

$$\angle ACB = ?$$

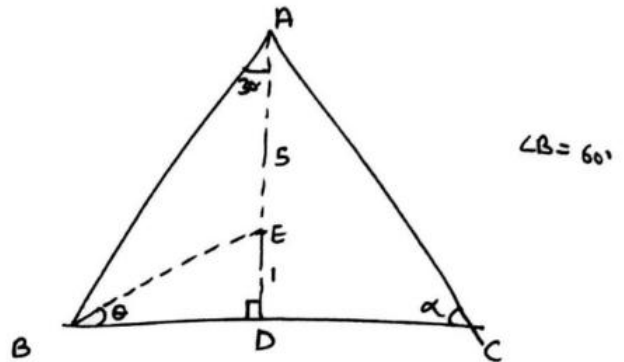

$$\tan \theta = \frac{1}{BD}$$

$$\tan \alpha = \frac{6}{DC}$$

$$\tan \alpha = 6 \tan \theta$$

$$\frac{6}{DC} = \frac{6}{BD}$$

$$\boxed{DC = BD}$$

$$\therefore AB = AC$$

$$\therefore \angle B = \angle C$$

$$\therefore \boxed{\angle C = 60^\circ}$$



#

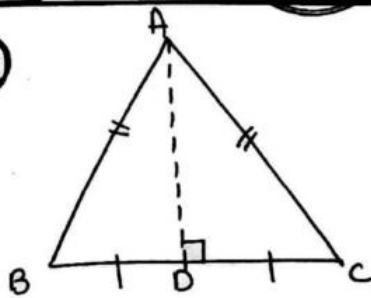

In an isosceles Δ , if a \perp is drawn from the common vertex of two equal sides on the opposite side then it will divide the opposite side in two equal parts.

ABC is isosceles Δ

$$AB = AC$$

$$AD \perp BC$$

$$\therefore \boxed{BD = DC}$$

& vice-versa.

105) The radius of two concentric circle are 13cm & 8cm. AB is the diameter of larger circle and BD is a tangent to the smaller circle touching it at D and the larger circle at E. Point A is joined to D. find AD.

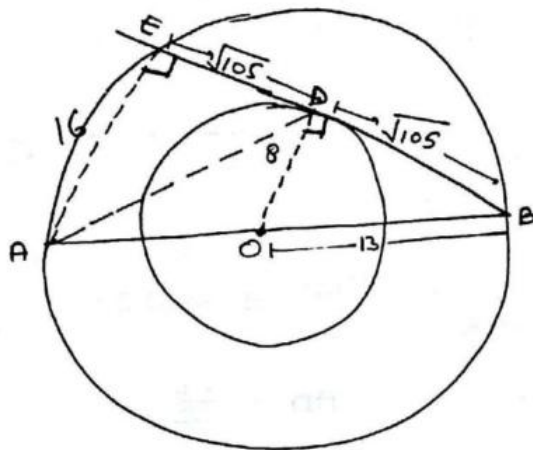

$$BD = \sqrt{105}$$

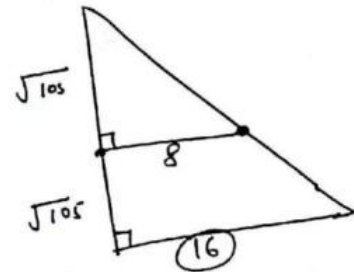

$$AD = \sqrt{(\sqrt{105})^2 + 16^2}$$

$$= \sqrt{105 + 256} = \sqrt{361}$$

$$AD = 19$$



106) AC and BC are two chords.

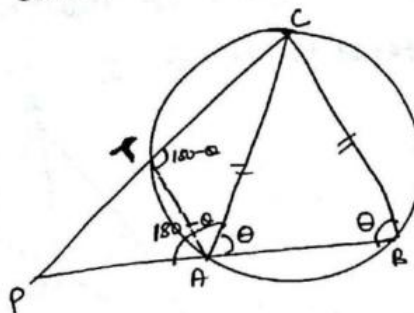
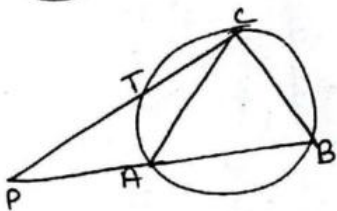

A) $CT : TP = AB : CA$

B) $CT : TP = CA : AB$

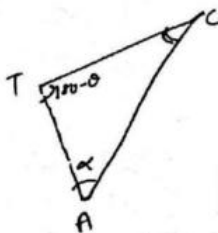
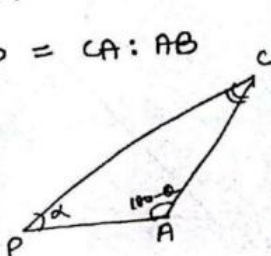

$$\frac{CT}{CA} = \frac{CA}{PC}$$

GoCareer.in

107) In an isosceles Δ $\angle B$ is right angle. D is a point in ΔABC and P & Q are points on AB and AC in such a way

$DP \perp AB$
 $PQ \perp AC$
 $AP = a$
 $AQ = b$
 $\angle BAD = 15^\circ$
 $\sin 75^\circ = ?$

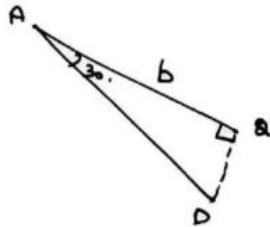
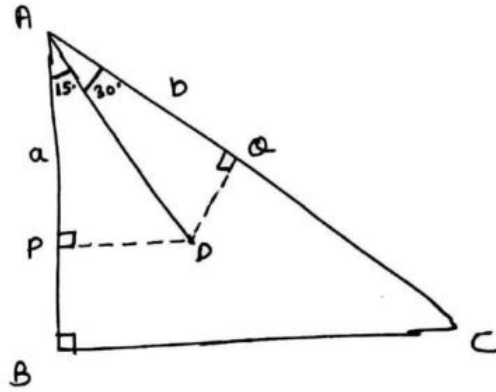

$$\frac{AD}{b} = \sec 30^\circ$$

$$AD = \frac{2b}{\sqrt{3}}$$

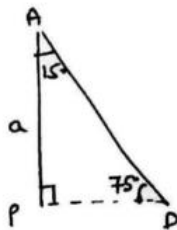

$$\sin 75^\circ = \frac{a}{AD} = \frac{a}{\frac{2b}{\sqrt{3}}} = \frac{\sqrt{3}a}{2b}$$

$$\sin 75^\circ = \frac{a\sqrt{3}}{2b}$$



108) E is the mid point of median AD of ΔABC . On extending BE it intersects AC at I .

$AB = 18$
 $AC = 15$
 $BC = 20$
 $CI = ?$

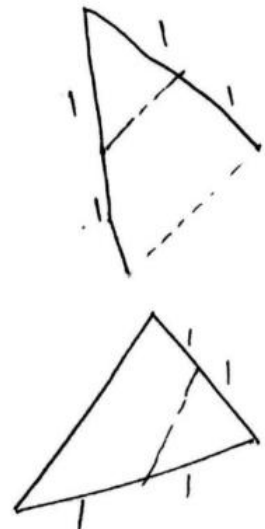
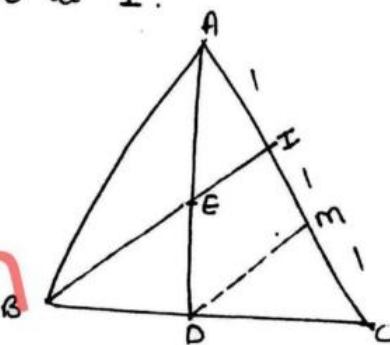

$3 \rightarrow 15$
 $1 \rightarrow 5$

$$CI = 10$$

Ans

GoCareer.in

CLASS
57

CO-ORDINATE Geometry.

⊕ $4x + 3y = 12$
 $2x + 5y = 10$
 $x = \frac{15}{7}, y = \frac{8}{7}$

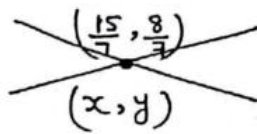

GoCareer.in

⊕ $a_1x + b_1y = c_1$
 $a_2x + b_2y = c_2$

unique solution $\Rightarrow \frac{a_1}{a_2} \neq \frac{b_1}{b_2}$

No solution $\Rightarrow \frac{a_1}{a_2} = \frac{b_1}{b_2} \neq \frac{c_1}{c_2}$

infinite many soln $\Rightarrow \frac{a_1}{a_2} = \frac{b_1}{b_2} = \frac{c_1}{c_2}$

(one line on another line)

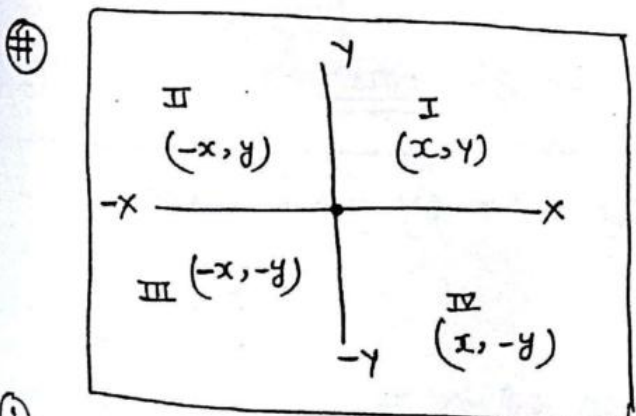

① $4x + 3y = 12$
 $x=0, y=4 \Rightarrow (0, 4)$
 $y=0, x=3 \Rightarrow (3, 0)$

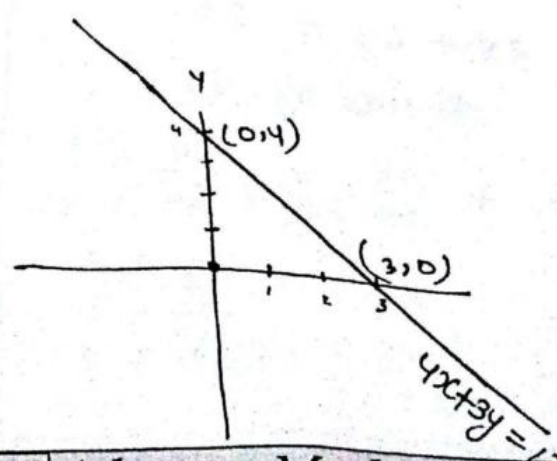

② find area of Δ made by $4x + 3y = 12$, x-axis and y-axis

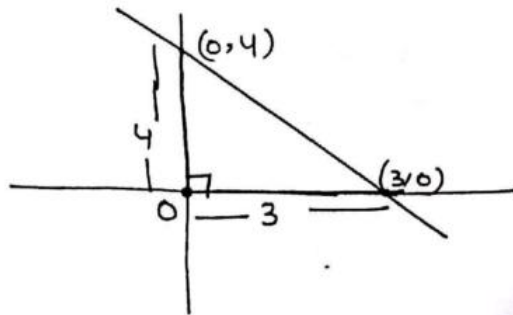

Area of $\Delta =$

$$\frac{1}{2} \times 3 \times 4 = 6 \text{ Ans.}$$

(OR)

if two sides of a Δ are x-axis and y-axis then it will be a right angle Δ .

Q. $4x + 3y = 12$

divide by 12

$$\frac{4x}{12} + \frac{3y}{12} = \frac{12}{12}$$

$$\frac{x}{3} + \frac{y}{4} = 1$$

Base \swarrow \searrow Perpendicular

$$\text{Area of } \Delta = \frac{1}{2} \times 3 \times 4 = 6 \text{ Ans.}$$

GoCareer.in

③ find area of Δ made by $8x + 6y = 60$, x-axis and y-axis.

$$8x + 6y = 60$$

divide by 60

$$\frac{8x}{60} + \frac{6y}{60} = \frac{60}{60}$$

$$\frac{x}{7.5} + \frac{y}{10} = 1$$

B \swarrow

P \searrow

Area of $\Delta =$

$$\Rightarrow \frac{1}{2} \times 7.5 \times 10$$

$$\Rightarrow 37.5 \text{ Ans.}$$

2) find the area of trapezium made by $8x+6y=60$, $4x+3y=12$, x-axis and y-axis.

$$8x+6y=60$$

$$x=0, y=10 \Rightarrow (0,10)$$

$$y=0, x=7.5 \Rightarrow (7.5,0)$$

$$4x+3y=12$$

$$x=0, y=4 \Rightarrow (0,4)$$

$$y=0, x=3 \Rightarrow (3,0)$$

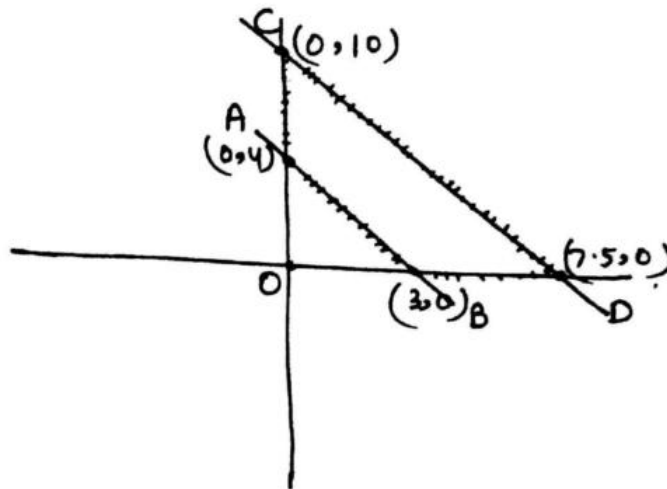

$$\text{Area of } \Delta OCD = \frac{1}{2} \times 10 \times 7.5 = 37.5$$

$$\text{Area of } \Delta OAB = \frac{1}{2} \times 4 \times 3 = 6$$

$$\begin{aligned} \text{Area of trapezium ABCD} &= \text{Area of } \Delta OCD - \text{Area of } \Delta OAB \\ &\Rightarrow 37.5 - 6 = 31.5 \text{ Ans.} \end{aligned}$$

3) find the area ~~made~~ of the trapezium made by $5x+3y=15$, $15x+9y=270$, x-axis and y-axis.

Area of Δ made by line $15x+9y=270$

$$\frac{15x}{270} + \frac{9y}{270} = \frac{270}{270}$$

$$\frac{x}{18} + \frac{y}{30} = 1$$

$$\Rightarrow \frac{1}{2} \times 18 \times 30 = 270$$

Area of Δ made by line $5x+3y=15$

$$\frac{5x}{15} + \frac{3y}{15} = \frac{15}{15}$$

$$\frac{x}{3} + \frac{y}{5} = 1$$

$$\Rightarrow \frac{1}{2} \times 3 \times 5 = 7.5$$

Area of trapezium =

$$270 - 7.5$$

$$= 262.5 \text{ Ans.}$$

GoCareer.in

⑥ find the area of Δ made by $4x+3y=12$, $5x+7y=35$ and x -axis.

$$4x+3y=12$$

$$y=0, x=3 \Rightarrow (3,0)$$

$$5x+7y=35$$

$$y=0, x=7 \Rightarrow (7,0)$$

$$4x+3y=12$$

$$5x+7y=35$$

$$y = \frac{80}{13}$$

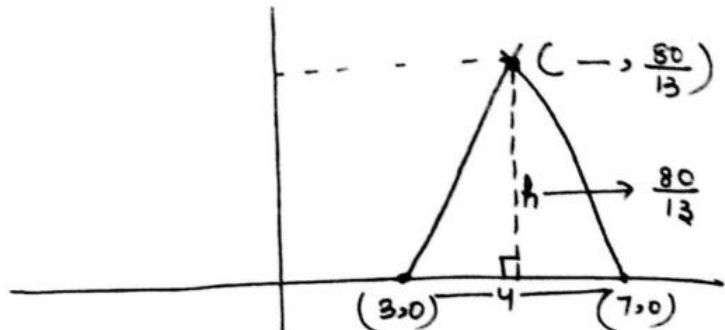

Area of $\Delta =$

$$\frac{1}{2} \times 4 \times \frac{80}{13}$$

$$= \frac{160}{13} \text{ Ans}$$

⑦ find the area of Δ made by $x+2y=8$, $5x+3y=15$ and y -axis.

$$x+2y=8$$

$$x=0, y=4 \Rightarrow (0,4)$$

$$5x+3y=15$$

$$x=0, y=5 \Rightarrow (0,5)$$

$$x+2y=8$$

$$5x+3y=15$$

$$x = \frac{6}{7}$$

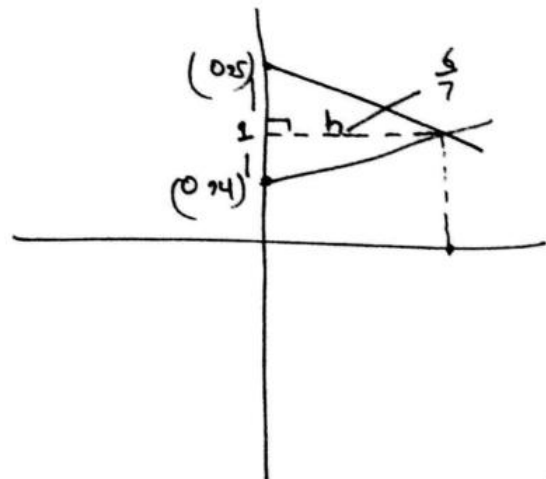

$$\text{Area} = \frac{1}{2} \times 1 \times \frac{6}{7}$$

$$= \frac{3}{7} \text{ Ans}$$

GoCareer.in

Linear Inequalities GoCareer.in

8) $4x + 3y \geq 12$

$4x + 3y = 12$

$x = 0, y = 4 \Rightarrow (0, 4)$

$y = 0, x = 3 \Rightarrow (3, 0)$

$4x + 3y \geq 12$

put $x = 0, y = 0$

$0 + 0 \geq 12$ (Not satisfied means shadow will be away from the origin.)

↓ if this condition satisfies then shadow will be towards the origin.

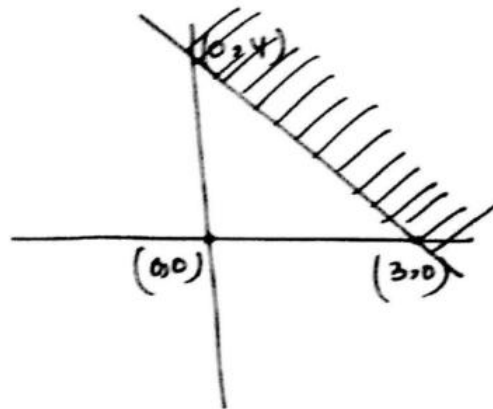

9) $x \geq -y$

$x = -y$

x	y
0	0
-1	1

$x \geq -y$

put $x = 1, y = 1$

$1 \geq -1$ (true - so shadow will be towards (1, 1))

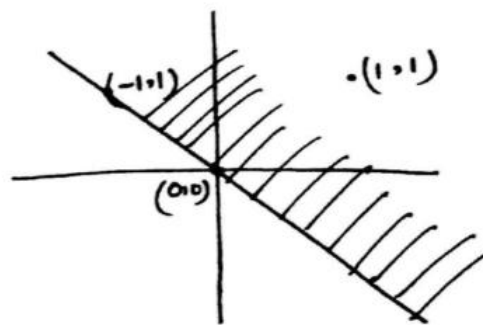

In this line either both positive or both -ve. So, option C & D can be

option A $\rightarrow x \geq y$

$-1 \geq 1$

(X)

Hence B ✓

Put $x = -1, y = 1$
(∵ in 2nd quad to check the condition).

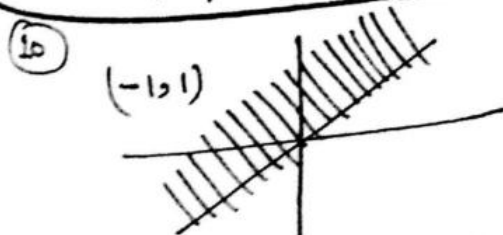

A) $x \geq y$

C) $x \geq -y$

~~B) $x \leq y$~~

D) $x \leq -y$

⑪ find the area of the figure bounded by $|x| + |y| = 4$

$$\begin{aligned} x + y &= 4 \\ -x + y &= 4 \\ x - y &= 4 \\ -x - y &= 4 \end{aligned}$$

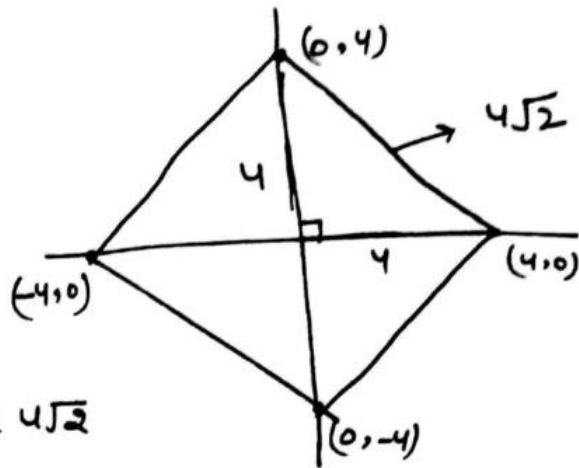

Square formed with side $4\sqrt{2}$

$$\text{Area} = (4\sqrt{2})^2 = 32 \text{ Ans}$$

⊕

if $|x| + |y| = K$
Area = $2K^2$

OR

$$\begin{aligned} \text{Area} &= 2(4)^2 \\ &= 32 \text{ Ans} \end{aligned}$$

⊕

$x + |y| = K$
 $|x| + y = K$
In both cases
Area = K^2

GoCareer.in

⊕



$$AB = \sqrt{(y_2 - y_1)^2 + (x_2 - x_1)^2}$$

#

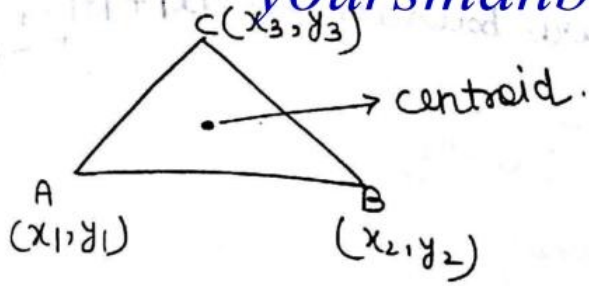

$$\text{Area}_{\triangle ABC} = \frac{1}{2} \left| x_1(y_2 - y_3) + x_2(y_3 - y_1) + x_3(y_1 - y_2) \right|$$

$$\text{Vertex of centroid} = \left(\frac{x_1 + x_2 + x_3}{3}, \frac{y_1 + y_2 + y_3}{3} \right)$$

#

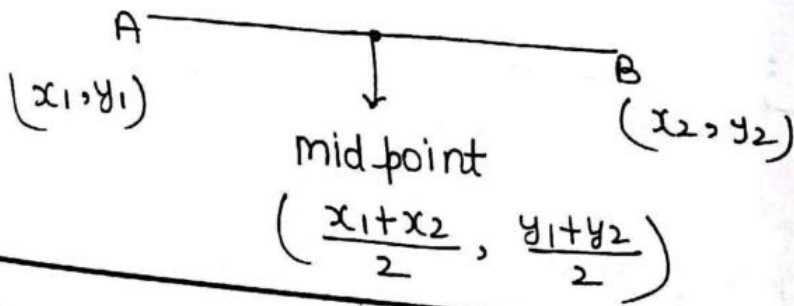

GoCareer.in

12) Find 4th vertex of a rhombus whose 3 vertices are $(-2, 3)$, $(3, 4)$, $(2, -7)$

mid point of diagonal \Rightarrow

$$\frac{2-2}{2}, \frac{-7+3}{2}$$

$$(0, -2)$$

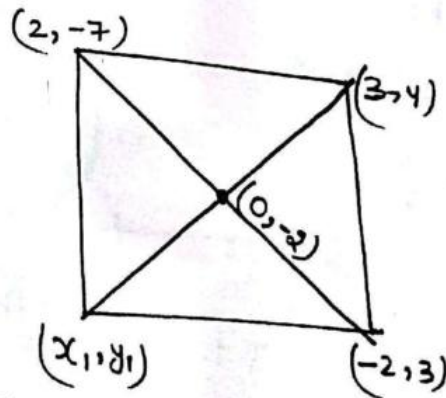

\therefore diagonals bisect each other

$$\frac{x_1 + 3}{2} = 0 \Rightarrow x_1 = -3$$

$$\frac{y_1 + 4}{2} = -2 \Rightarrow y_1 = -8$$

$(-3, -8)$ Ans.

##

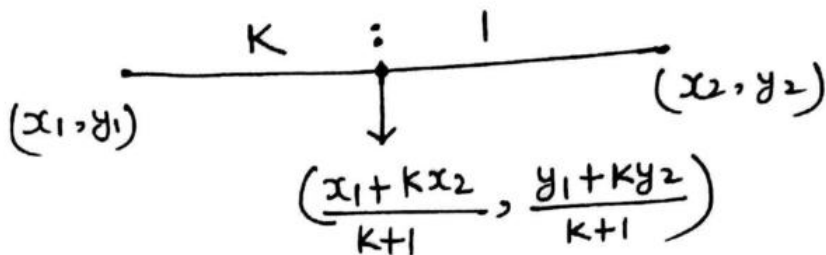

13) find the ratio in w/c y-axis intersect the line PA

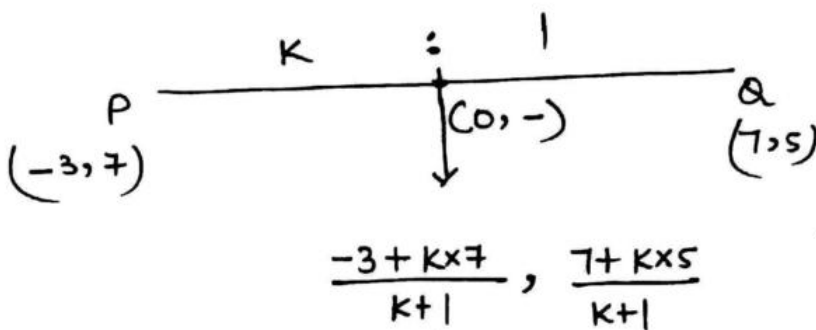

$$\frac{-3 + 7K}{K+1} = 0 \quad (\text{on y axis, x is zero})$$

$$-3 + 7K = 0$$

$$K = \frac{3}{7}$$

$$\text{Ratio} \Rightarrow \frac{3}{7} : 1$$

$$3 : 7 \quad \underline{\text{Ans:}}$$



GoCareer.in

SLOPE

⊕

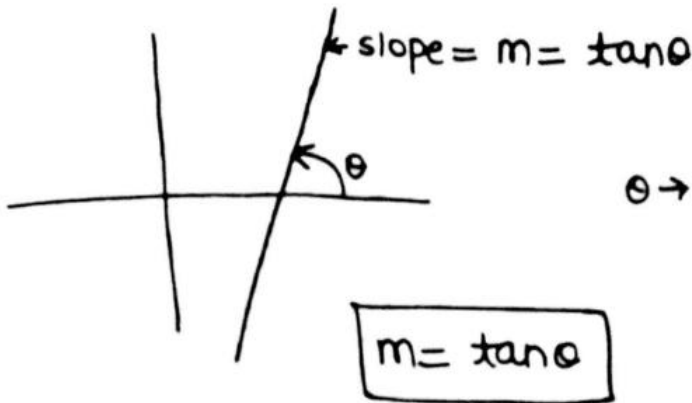

$\theta \rightarrow$ always anticlockwise वाला लेना है ।

⊕

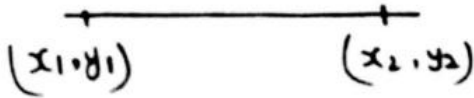

$$m = \frac{y_2 - y_1}{x_2 - x_1}$$

GoCareer.in

⊕

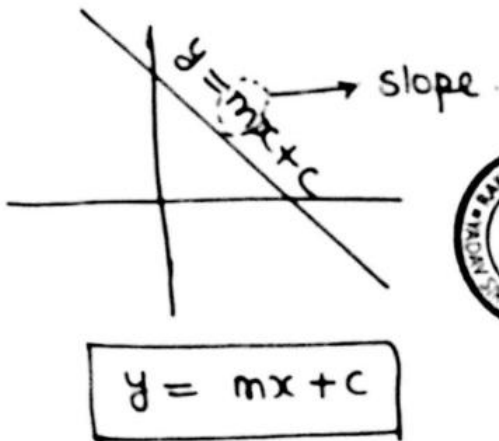

$$4x + 3y = 12$$

$$3y = -4x + 12$$

$$y = \frac{-4}{3}x + \frac{12}{3}$$

$$\text{slope}(m) = \frac{-4}{3}$$

⊕

$\sqrt{3}y - 3x = 5$, find slope ($\theta = ?$)

$$\sqrt{3}y = 3x + 5$$

$$y = \frac{3}{\sqrt{3}}x + \frac{5}{\sqrt{3}}$$

$$y = \underbrace{\left(\sqrt{3}\right)}_{\text{slope}}x + \frac{5}{\sqrt{3}}$$

$$\text{Tan } \theta = \sqrt{3}$$

$$\text{Tan } \theta = \text{Tan } 60$$

$$\theta = 60^\circ \quad \underline{\text{Ans}}$$

⑮ Find the angle between lines

$$x - y\sqrt{3} = 5$$

$$\sqrt{3}x + y = 7$$

$$x - y\sqrt{3} = 5$$

$$y\sqrt{3} = x - 5$$

$$y = \left(\frac{x}{\sqrt{3}}\right) - \frac{5}{\sqrt{3}}$$

$$m_2 = \frac{1}{\sqrt{3}}$$

$$\sqrt{3}x + y = 7$$

$$y = -\sqrt{3}x + 7$$

$$m_1 = -\sqrt{3}$$

⊕

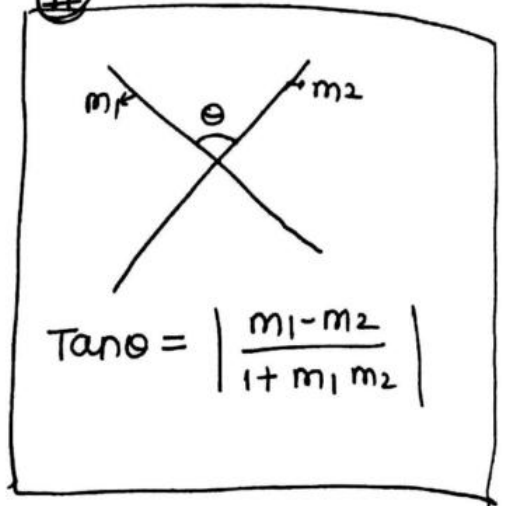

$$\tan \theta = \left| \frac{-\sqrt{3} - \frac{1}{\sqrt{3}}}{1 + (-\sqrt{3}) \frac{1}{\sqrt{3}}} \right|$$

$$\tan \theta = \infty = \tan 90^\circ$$

$$\theta = 90^\circ$$

⑯ Find the perpendicular distance b/w $4x + 3y = 16$ &

$$8x + 6y = 18$$

$$4x + 3y = 16$$

$$4x + 3y = 9$$



$$ax + by = c_1$$

$$ax + by = c_2$$

$$\perp \text{ distance} = \left| \frac{c_1 - c_2}{\sqrt{a^2 + b^2}} \right|$$

$$\perp \text{ distance} = \left| \frac{16 - 9}{\sqrt{4^2 + 3^2}} \right| = \frac{7}{5} \text{ Ans}$$

⊕

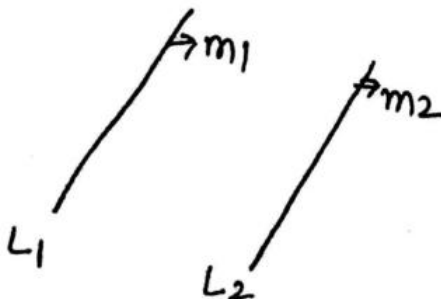

if $L_1 \parallel L_2$

$$m_1 = m_2$$

7) find the \perp distance from a vertex $(-3, 2)$ to the line $3x + 4y = 16$.

$$\perp \text{ distance} = \left| \frac{-9 + 8 + 16}{\sqrt{4^2 + 3^2}} \right|$$

$$= \frac{+5}{5} = 3 \text{ Ans.}$$

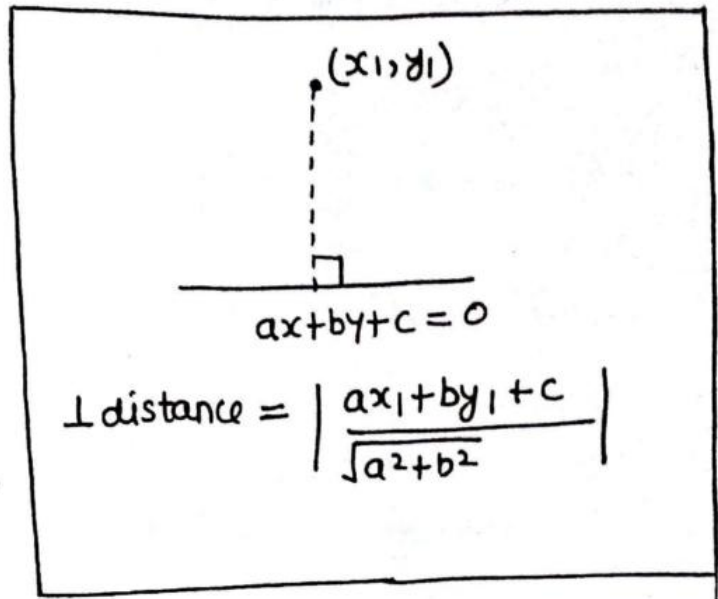

GoCareer.in

2D-MENSURATION

CLASS 5B

Equilateral Δ

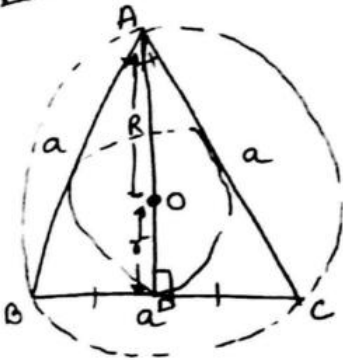

$$\text{Area} = \frac{\sqrt{3}}{4} a^2$$

$$\text{Altitude} = \frac{\sqrt{3}}{2} a$$

$$r = \frac{a}{2\sqrt{3}}$$

$$R = \frac{a}{\sqrt{3}}$$

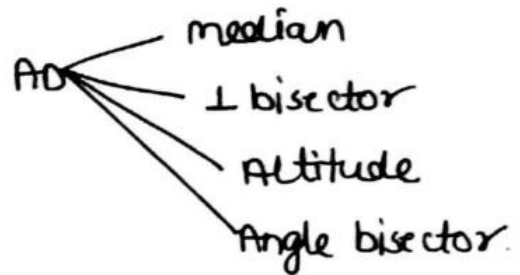
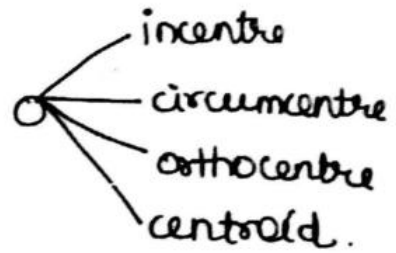

$$\frac{\text{Area (circumcircle)}}{\text{Area (incircle)}} = \frac{4}{1}$$

$$\frac{\text{Radius (circumcircle)}}{\text{Radius (incircle)}} = \frac{2}{1}$$

GoCareer.in

#

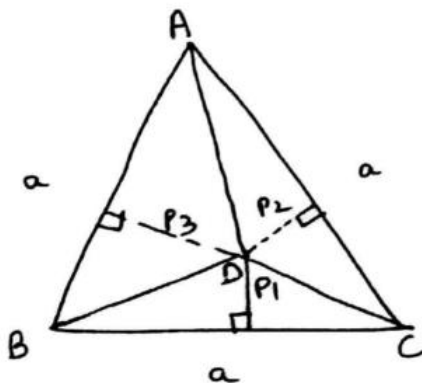

$$\text{Ar}(\text{BDC}) = \frac{1}{2} \times a \times P_1$$

$$\text{Ar}(\text{ADC}) = \frac{1}{2} \times a \times P_2$$

$$\text{Ar}(\text{ABD}) = \frac{1}{2} \times a \times P_3$$

$$\frac{1}{2} \times a \times P_1 + \frac{1}{2} \times a \times P_2 + \frac{1}{2} \times a \times P_3 = \frac{\sqrt{3}}{4} a^2$$

$$\frac{\sqrt{3}}{2} a = P_1 + P_2 + P_3$$

$$a = \frac{2}{\sqrt{3}} (P_1 + P_2 + P_3)$$

① find the area of the equilateral Δ in w/c three altitudes of length $\sqrt{3}$, $2\sqrt{3}$, $5\sqrt{3}$ are drawn from a ~~side~~ point inside the Δ .

$$a = \frac{2}{\sqrt{3}} (\sqrt{3} + 2\sqrt{3} + 5\sqrt{3}) = \frac{2}{\sqrt{3}} \times 8\sqrt{3} = 16$$

$$\text{Area} = \frac{\sqrt{3}}{4} \times 16 \times 16 = 64\sqrt{3} \text{ Ans}$$

#

ISOSCELES Triangle

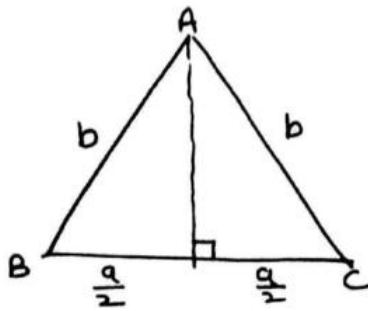

Altitude = $\frac{1}{2} \sqrt{4b^2 - a^2}$

Area = $\frac{a}{4} \sqrt{4b^2 - a^2}$

② find the area of a Δ whose sides are 5, 5 & 6 cm

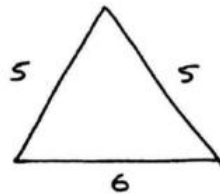

Area = $\frac{6}{4} \sqrt{100 - 36}$
 = $\frac{6}{4} \times 8^2 = 12 \text{ cm}^2$

③ Find the area of Δ whose sides are 5, 6 & 7 cm.

$s = \frac{5+6+7}{2} = 9$

Area = $\sqrt{9 \times 4 \times 3 \times 2} = \sqrt{216} = \sqrt{36 \times 6} = 6\sqrt{6} \text{ cm}^2$

#

Scalene Δ

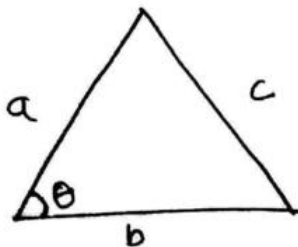

$s = \frac{a+b+c}{2}$ | Area = $\frac{1}{2} \times a \times b \times \sin C$

Area $\Delta = \sqrt{s(s-a)(s-b)(s-c)}$

$r = \frac{A}{s}$, $R = \frac{abc}{4A}$

④ find the area of a square (maximum size) w/c can inscribed in a right angle Δ of side 6, 8, 10 cm

Ex 6.8
= 24

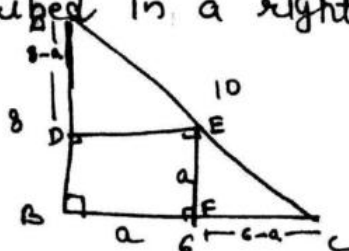

$\frac{1}{2} \times a \times (8-a) + \frac{1}{2} \times (6-a) \times a + a^2 = 24$

ΔADE ΔEFC $\square BDEF$

$7a - a^2 + a^2 = 24$

$a = \frac{24}{7}$

Area = $\frac{576}{49}$

side of the maximum size square inscribed in a right angle $\Delta =$

$$a = \frac{P \times B}{P+B}$$

GoCareer.in

$$\rightarrow \frac{8 \times 6}{8+6} = \frac{48}{14} = \frac{24}{7}$$

Square

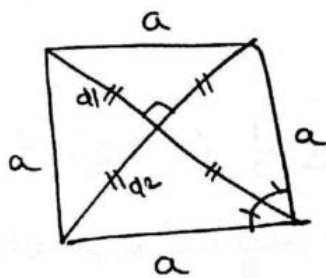

$$\text{Area} = a^2$$

$$P = 4a$$

$$d_1 = d_2$$

Rhombus

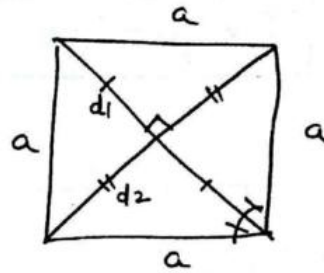

$$\text{Area} = \frac{1}{2} \times d_1 \times d_2$$

$$P = 4a$$

$$d_1 \neq d_2$$

$$\text{Area} = a^2 \sin \theta$$

5) Find the area of a rhombus whose 3 vertices lie on the circumference of a circle and one vertex lie on the centre of circle of radius 10 cm.

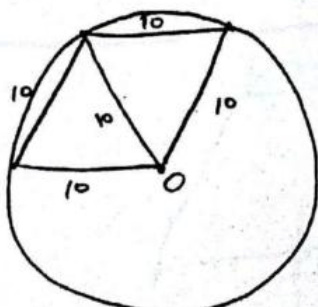

$$2 \times \left(\frac{\sqrt{3}}{4} \times 10 \times 10 \right) = 50\sqrt{3}$$

#

Rectangle

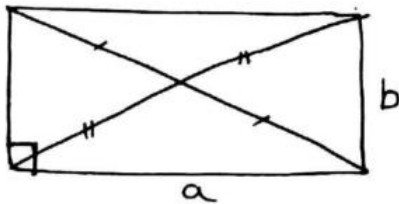

Area = $a \times b$

P = $2(a+b)$

Parallelogram

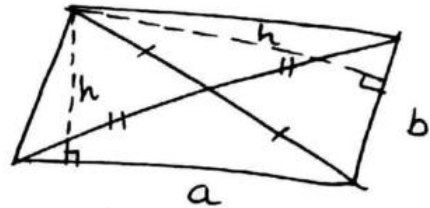

Area = $a \times h = b \times h$

GoCareer.in

#

Trapezium

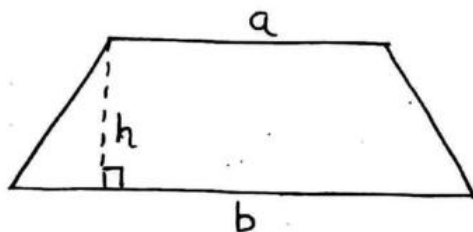

Area = $\frac{1}{2} (a+b) \times h$

= Avg of 2 parallel lines $\times h$

6

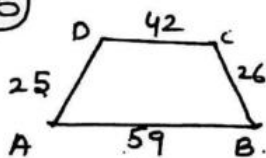

AB || CD
find Area.

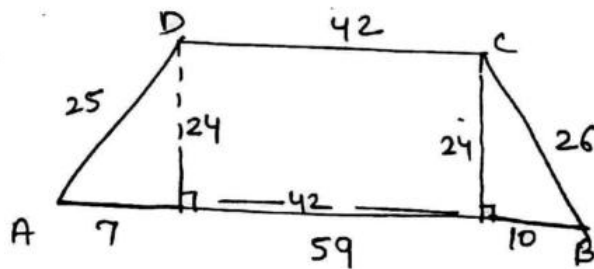

7 (25, 26, 24, 10, 7)

$\frac{1}{2} \times (42+59) \times 24 = 1212$

$101 \times 12 = 1212$

7

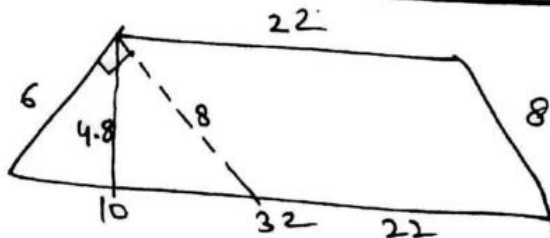
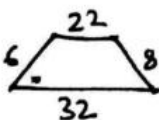

$\frac{1}{2} \times (22+32) \times 4.8 = 129.6$

⑧ The ratio of length of two parallel lines is 1:3 of a trapezium while non-parallel sides ratio is 2:3 if the ratio of length of larger parallel line to the larger non-parallel line is 2:1. & height is $\frac{15\sqrt{15}}{4}$ cm find the area of the trapezium.

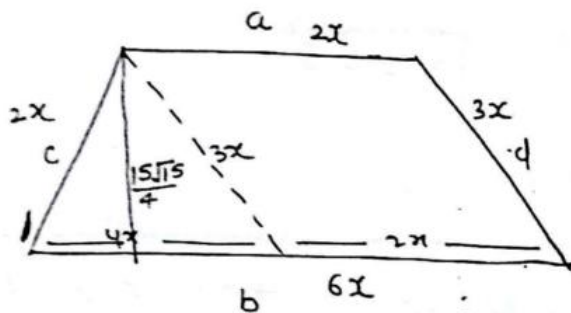

$$\begin{array}{l} a : b \quad c : d \\ 1x2 : 3x2 \quad 2 : 3 \\ \downarrow \quad \quad \downarrow \\ 2 \quad : \quad 1 \\ 2x : 6x : 2x : 3x \end{array}$$

① $S = \frac{2x+3x+4x}{2} = \frac{9}{2}x$

$$\text{Area} = \sqrt{\frac{9}{2}x \times \frac{5}{2}x \times \frac{3}{2}x \times \frac{1}{2}x}$$

$$\frac{3x^2\sqrt{15}}{4}$$

$$\therefore \frac{1}{2} \times 4x \times \frac{15\sqrt{15}}{4} = \frac{3x^2\sqrt{15}}{4} \quad (\text{equating area of } \Delta)$$

$$\boxed{x=10}$$

$$\text{Area of Trapezium} = \frac{1}{2} (20+60) \times \frac{15\sqrt{15}}{4} = 150\sqrt{15}$$

⑨ find the side of a maximum size square w/c can be inscribed in a semi-circle of radius r. cm.

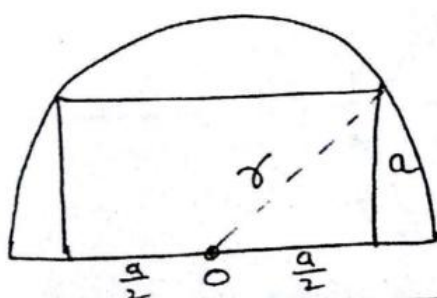

$$r^2 = a^2 + \frac{a^2}{4}$$

$$r = \frac{\sqrt{5}}{2} a$$

$$a = \frac{2r}{\sqrt{5}} \quad \underline{\underline{\text{Ans}}}$$

- ⑩ A brick of 5cm is placed against a wheel. The horizontal distance of the face of the brick stopping the wheel from the point where the wheel touches the ground is 15 cm. find the radius of wheel.

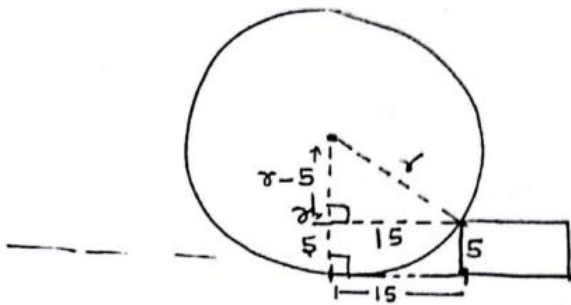

$$r^2 = (r-5)^2 + 15^2$$

$$r = 25$$

- ⑪ find the radius of maximum size circle that can be inscribed in a square. If a rectangle of length 20 cm and breadth 10 cm is constructed in the corner of the square b/w the space of square & circle. The three vertices of \square lies on the ~~circumference~~ square and one vertex lies on the circumference of circle.

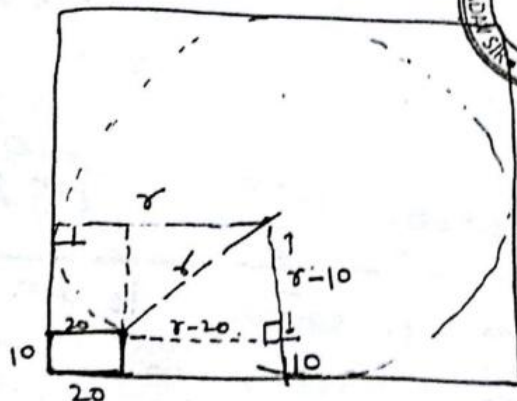

$$r^2 = (r-10)^2 + (r-20)^2$$

$$r = 50$$



Hexagon

$$\begin{aligned} \text{Area} &= 6 \times \frac{\sqrt{3}}{4} a^2 \\ &= \frac{3\sqrt{3}}{2} a^2 \end{aligned}$$

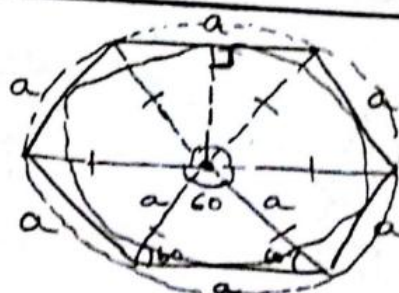

Radius of circumcircle = a (side of Hexagon)
(R)

Radius of incircle (r) = $\frac{\sqrt{3}}{2} a$

② find the ratio of length of an equilateral Δ and a regular hexagon w/c are on the circumference of the circle.

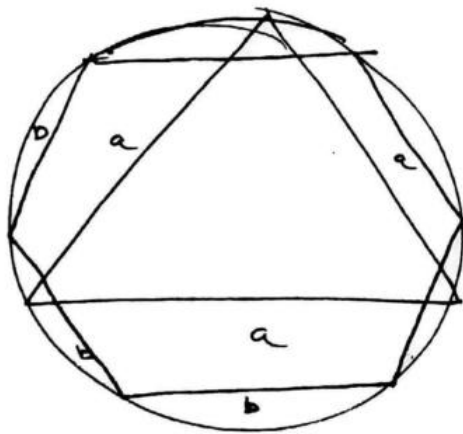

$$r = \frac{a}{\sqrt{3}} \text{ (from } \Delta \text{)}$$

$$r = b \text{ (from Hexagon)}$$

$$\frac{a}{\sqrt{3}} = b \text{ (Equate both } r \text{)}$$

$$\boxed{\frac{a}{b} = \frac{\sqrt{3}}{1}}$$

Ans.

#

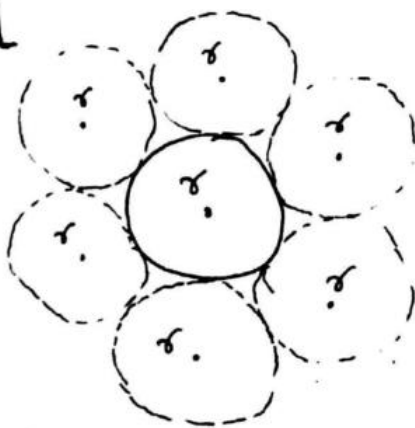

Around a circle of radius r , only 6 circles can be drawn w/c touches the main circle and two other circle of the same radius r .

13

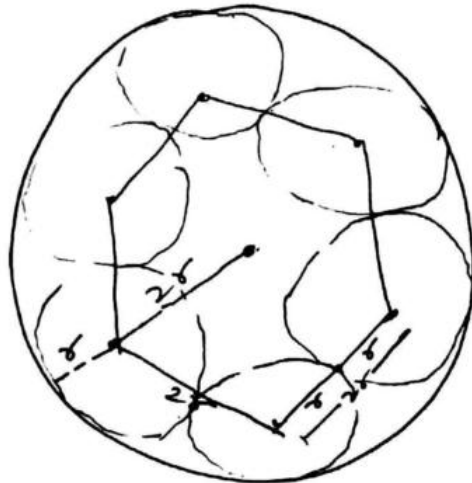

$$R = 10$$

$$r = ?$$

$$3r = 10$$

$$r = \frac{10}{3}$$

GoCareer.in

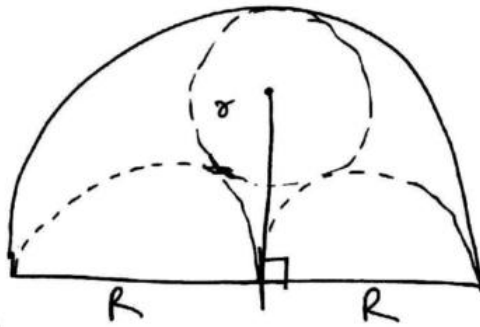

$$r = \frac{R}{3}$$

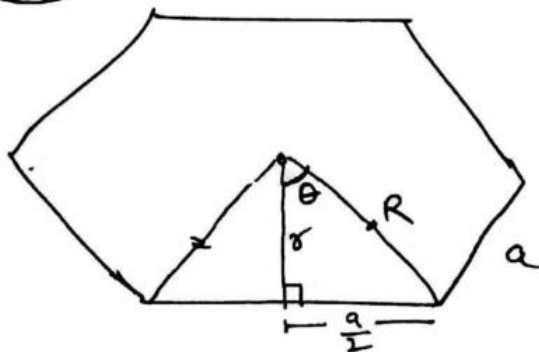

circum-circle radius of any polygon =

$$\frac{a}{2} \operatorname{cosec} \frac{180^\circ}{n}$$

in-circle radius of any polygon = $\frac{a}{2} \cot \frac{180^\circ}{n}$

Area of any polygon of n sides = $\frac{na^2}{4} \cot \frac{180^\circ}{n}$

CLASS
59

#

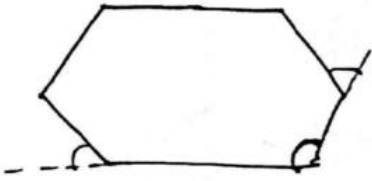

* Sum of all internal angles = $(n-2) \times 180^\circ$

* Each interior angle = $\frac{(n-2) \times 180^\circ}{n}$

* Sum of all exterior angles = 360°

* Each exterior angle = $\frac{360^\circ}{n}$

* NO. of diagonal = $\frac{n(n-3)}{2}$

(14) find the no. of sides of a polygon in w/c the no. of diagonals are 27.

$$\frac{n(n-3)}{2} = 27$$

$$n(n-3) = 54$$

$$\begin{matrix} \downarrow & \downarrow \\ 9 & 6 \end{matrix}$$



GoCareer.in

$$\boxed{n=9}$$

(15) find the no. of sides in a regular polygon in w/c the ratio of each external angle to each internal angle is

2:3

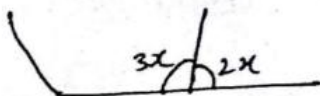

$$5x = 180^\circ$$

$$2x = 72^\circ$$

$$\frac{360^\circ}{n} = 72^\circ$$

$$\boxed{n=5}$$

(16) find the length of the side of a regular octagon w/c is formed by cutting the corner of a square of side 10 cm

⑤ Area of any octagon = $2a^2(1+\sqrt{2})$

⑥ side of square = side of octagon $(\sqrt{2}+1)$

$$10 = \text{side of octagon } (\sqrt{2}+1)$$

$$\text{side of octagon} = \frac{10}{(\sqrt{2}+1)}$$

- ①⑦ Three circles of radius 1 cm touch one another externally. Find the area of the circle circumscribing the three circles.

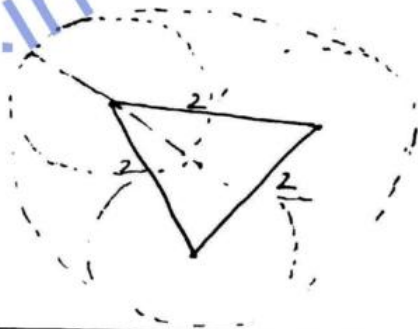

$$R = \frac{a}{\sqrt{3}} = \frac{2}{\sqrt{3}}$$

$$\frac{2}{\sqrt{3}} + 1 = \frac{2+\sqrt{3}}{\sqrt{3}}$$

- ①⑧ The length of a rectangular sheet is 10 cm. What would be its minimum breadth so that 9 circular sheets of radius 1 cm can be cut out from it.

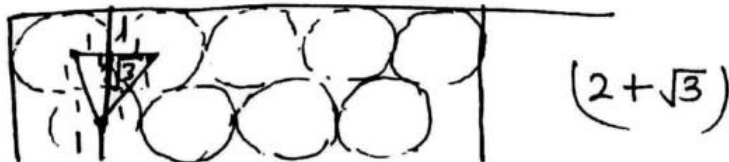

- ①⑨ Find the length of common arc of three circles of radius 1 cm, $(\sqrt{2}+1)$ cm, $(\sqrt{2}+1)$ cm touches one another externally.

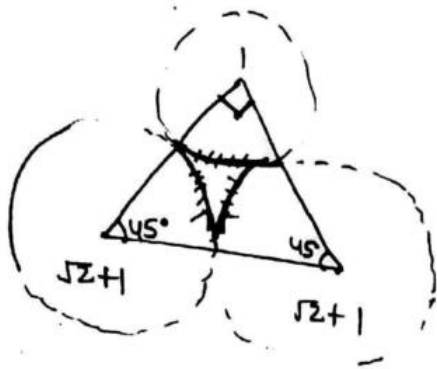

$$\text{Arc} = \frac{\theta}{180} \pi r$$

बसि के ये case में arc निकाल सकते हैं या तो Δ equilateral हो या फिर right angle isosceles है।

$$\frac{90^\circ}{180} \pi (1) + \frac{45^\circ}{180} \pi (\sqrt{2}+1) \times 2$$

$$\frac{\pi}{2} + \frac{\pi}{2} (\sqrt{2}+1)$$

$$\frac{\pi}{2} [1 + \sqrt{2}+1] = \frac{\pi}{2} [2 + \sqrt{2}]$$

20) find the length of minimum rubber band w/c can hide three circle of radius 14 cm

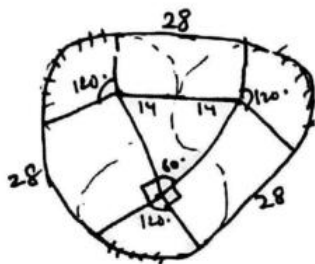

$$\frac{120}{180} \times \pi \times 14 \times 3$$

$$= 88$$

$$\text{length of Rubber band} = 84 + 88 = \underline{172 \text{ cm}}$$

\Rightarrow min. length of Rubber band = $3D + 2\pi r$

⊕ \Rightarrow min. length of Rubber band = $6D + 2\pi r$

⊕ \Rightarrow min length of Rubber band = $9D + 2\pi r$

(21)

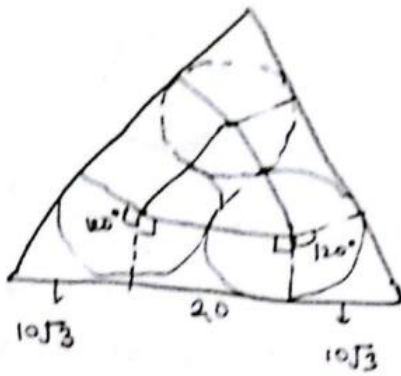

radius = 10 cm
 find perimeter of Δ .

Perimeter =
 $3(20 + 10\sqrt{3} + 10\sqrt{3})$

$60 + 60\sqrt{3}$

$60(1 + \sqrt{3})$

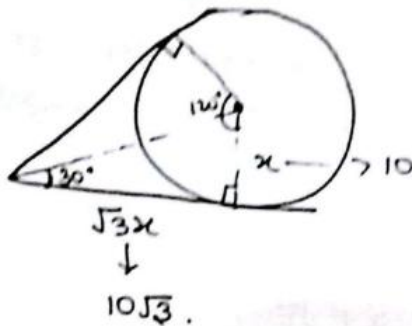

GoCareer.in

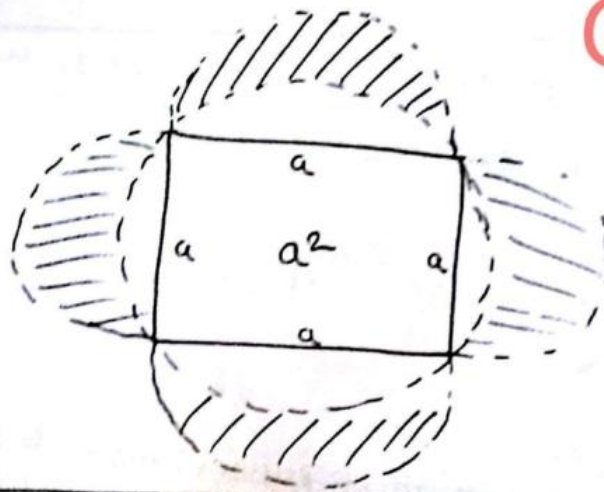

Area of shaded portion = Area of base figure = a^2

(22)

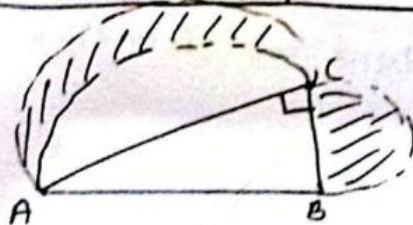

Area $\Delta ABC = 50$
 find area of shaded portion.

Area of shaded portion = 50.

CLASS
60

3D-MENSURATION

Prism

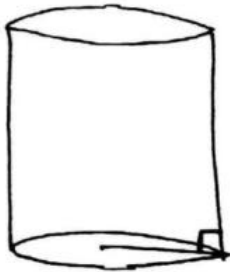

$$\text{Vol.} = \text{Base Area} \times \text{Height}$$

$$\text{L.S.A} = \text{Base Perimeter} \times H$$

$$\text{T.S.A} = \text{L.S.A} + 2 \cdot \text{Base Area}$$

Pyramid

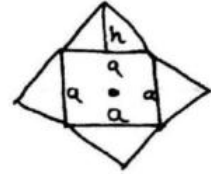

$$\text{Vol.} = \frac{1}{3} \times \text{Base Area} \times \text{Height}$$

$$\text{L.S.A} = \frac{1}{2} \times \text{Base Perimeter} \times \text{slant Height}$$

$$\text{T.S.A} = \text{L.S.A} + \text{Base Area}$$

- ① Find the vol of a prism w/c is based on regular octagon of side 10 cm and height of the prism is 63 cm.

$$\text{Vol. of prism} = \text{Base Area} \times H.$$

$$2 \times 10 \times 10 (\sqrt{2} + 1) \times 63.$$

- ② The base of a right prism is a Δ of side: 5, 12, 13 cm and its vol. is 450 cm^3 . find its Total surface area.

$$450 = 30 \times H$$

$$H = 15 \text{ cm}$$

$$\text{T.S.A} = \frac{\text{L.S.A}}{30 \times 15} + \frac{2 \cdot \text{Base Area}}{2 \times 30}$$

$$= 510 \text{ cm}^2$$

- ③ The base of a right prism is a Δ of perimeter 45 cm and its incircle radius is 9 cm. find its T.S.A if its

$$\text{Vol. is } 810 \text{ cm}^3.$$

$$r = \frac{A}{s}$$

$$9 = \frac{A}{\frac{45}{2}}$$

$$\text{Area of } \Delta = 9 \times \frac{45}{2}$$

$$\text{Vol.} = B.A \times H$$

$$\frac{2 \cdot 90}{810} = 9 \times \frac{45}{2} \times H$$

$$H = 4$$

$$\text{T.S.A} = 45 \times 4 = 180$$

$$\text{T.S.A} = \text{L.S.A} + 2 \left(9 \times \frac{45}{2} \right)$$

$$= 180 + 405$$

$$= 585 \text{ cm}^2$$

- ④ The base of a right prism is a quadrilateral ABCD. and the vol. of the prism is 2070 cm^3 . find its L.S.A.

$$\begin{aligned} AB &= 9 \\ BC &= 14 \\ CD &= 13 \\ AD &= 12 \\ \angle A &= 90^\circ \end{aligned}$$

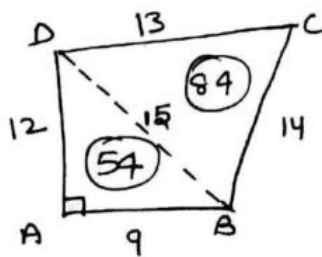

$$\frac{1}{2} \times 9 \times 12 = 54$$

$$\text{Vol.} = B.A \times H.$$

$$B.A = 54 + 84 = 138$$

$$\Rightarrow 2070 = 138 \times H$$

$$H = 15$$



$$\begin{aligned} \text{L.S.A} &= \text{Base Perimeter} \times \text{Height} \\ &= 48 \times 15 = 720 \text{ cm}^2 \end{aligned}$$

GoCareer.in

- ⑤ The height of a right prism is 15 cm w/c is based on a square. If its total surface area is 608 cm^2 . find its volume.



$$\text{T.S.A} = 608$$

$$4a \times 15 + 2a^2 = 608$$

$$30a + a^2 = 304$$

$$a(30+a) = 304$$

$$\begin{array}{cc} \downarrow & \downarrow \\ 8 & 8 \end{array} \quad (\rightarrow \text{By unit digit concept})$$

$$a = 8$$

$$\text{Vol.} = 64 \times 15 = 960 \text{ cm}^3$$

⑥ find the vol. of a right prism w/c is based on a regular hexagon of height 10 cm. If its T.S.A is $156\sqrt{3}$ cm.

$$6a \times 10 + 2 \times \frac{3\sqrt{3}}{2} a^2 = 156\sqrt{3}$$

$$20a + \sqrt{3} a^2 = 52\sqrt{3}$$

$$a(20 + \sqrt{3}a) = 52\sqrt{3}$$

$$2\sqrt{3}(20 + \sqrt{3} \times 2\sqrt{3}) = 52\sqrt{3}$$

$$2\sqrt{3} \times 26 = 52\sqrt{3}$$

so: $a = 2\sqrt{3}$

$$\text{Vol.} = \frac{3\sqrt{3}}{2} \times (2\sqrt{3})^2 \times 10$$

put value of $a = \sqrt{3}, 2\sqrt{3}, 3\sqrt{3}, 4\sqrt{3}$.
 $\therefore \sqrt{3}a$ का root खत्म करना है otherwise पी 20 में add नहीं होगा

① **Cube**

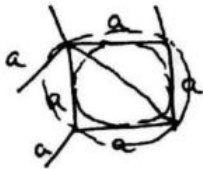

$$\text{Vol.} = a^3$$

$$\text{L.S.A} = 4a^2$$

$$\text{T.S.A} = 6a^2$$

$$D = \sqrt{3}a$$

$$r = \frac{a}{2}$$

$$R = \frac{\sqrt{3}}{2}a$$

GoCareer.in

② **Cuboid**

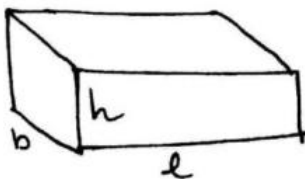

$$V = lbh$$

$$\text{L.S.A} = 2(l+b)h$$

$$\text{T.S.A} = 2(lb + bh + hl)$$

$$\text{Diagonal (D)} = \sqrt{l^2 + b^2 + h^2}$$

- ⊕ A cuboid can be put in hemisphere.
and the radius of hemisphere is =

$$R = \frac{1}{2} \sqrt{4h^2 + l^2 + b^2}$$

GoCareer.in

- ③ Cylinder.

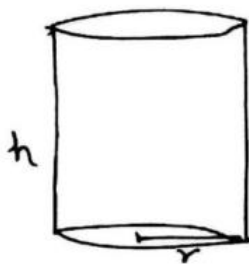

$$V = \pi r^2 h$$

$$L.S.A = 2\pi r h$$

$$T.S.A = L.S.A + 2\pi r^2 \\ = 2\pi r (r + h)$$

- ⑦ find the vol. of a pyramid w/c is based on a regular hexagon of side $2\sqrt{3}$ cm and height of pyramid is 15 cm.

$$\text{vol.} = \frac{1}{3} \times \frac{3\sqrt{3}}{2} \times \frac{6}{12} \times 15 = 90\sqrt{3} \text{ Ans}$$

- ⑧ find the vol. of a pyramid w/c is based on a square of side 6 cm and its slant height is 5 cm.

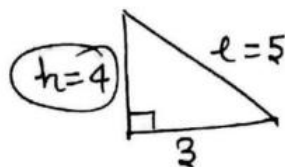
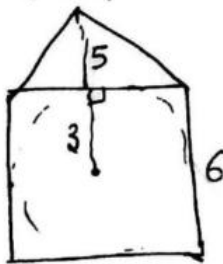

$$\text{vol.} = \frac{1}{3} \times 36 \times 4 = 48 \text{ cm}^3$$

- 9) find the T.S.A of a pyramid of height 15 cm w/c is based on a square of side 16 cm.

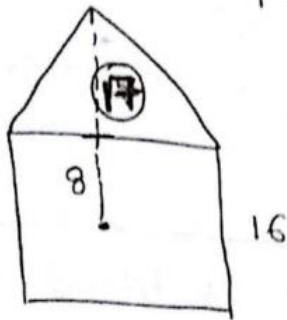

GoCareer.in

$$\begin{aligned} \text{T.S.A} &= \text{L.S.A} + \text{B.A} \\ &= \frac{1}{2} \times 16 \times 17 + 256 \\ &= 800 \text{ cm}^2 \end{aligned}$$

* Radius of incircle in the square = $\frac{a}{2}$

- 10) find the T.S.A of a pyramid w/c is based on a regular hexagon of side $6\sqrt{3}$ cm and height 12 cm.

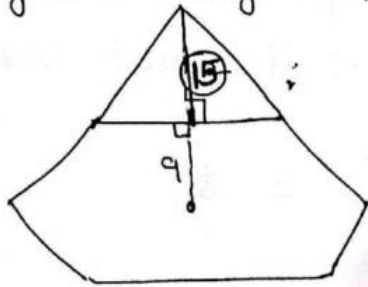

$$r = \frac{\sqrt{3}}{2} \times 6\sqrt{3} = 9$$

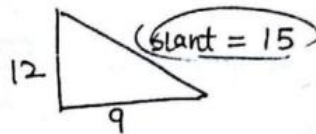

$$\text{Base Area} = \frac{\sqrt{3}}{4} \times (6\sqrt{3})^2 \times 6 = 162\sqrt{3}$$

$$\text{C.S.A} = \frac{1}{2} \times 6 \times 6\sqrt{3} \times 15 = 270\sqrt{3}$$

$$\text{T.S.A} = 270\sqrt{3} + 162\sqrt{3} = 432\sqrt{3}$$

- 11) find the vol. of a pyramid w/c is based on regular hexagon of side 10 cm. and having slant edge 13 cm

$slant\ height = 12$
 $h = \sqrt{144 - 75} = \sqrt{69}$

$vol. = \frac{1}{3} \times \frac{3\sqrt{3}}{2} \times 5 \times 10 \times \sqrt{69} = 50\sqrt{207}$

② find the vol. of a pyramid w/c is based on hexagon of side $4\sqrt{3}$ and having slant ~~edge~~ height 10 cm.

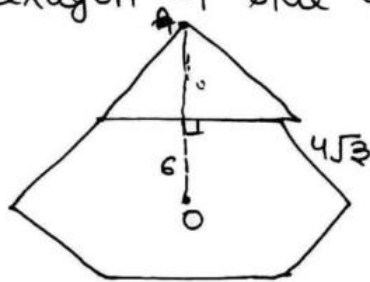

$r = \frac{\sqrt{3}}{2} \times 4\sqrt{3} = 6$

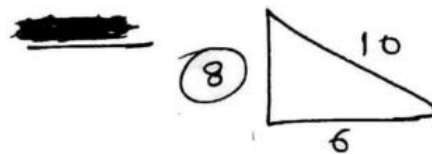

$vol. = \frac{1}{3} \times \frac{3\sqrt{3}}{2} \times \frac{24}{48} \times 8 = 192\sqrt{3}$

⑬ find the vol. of a pyramid w/c is based on an equilateral Δ of side $6\sqrt{3}$ cm if its slant height is 5 cm.

$r = \frac{6\sqrt{3}}{2\sqrt{3}} = 3$

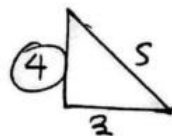
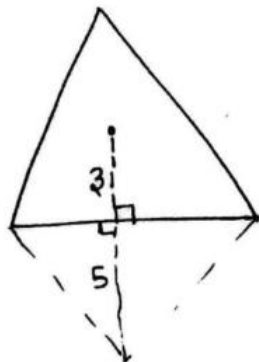

$vol. = \frac{1}{3} \times \frac{\sqrt{3}}{4} \times \frac{36}{108} \times 4 = 36\sqrt{3}$

Tetrahedron

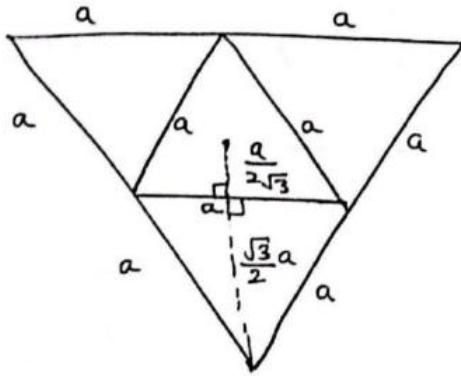

$$\begin{aligned} \text{Height} &= \frac{\sqrt{2}}{\sqrt{3}} a \\ \text{Vol.} &= \frac{\sqrt{2}}{12} a^3 \\ \text{L.S.A} &= \frac{3\sqrt{3}}{4} a^2 \\ \text{T.S.A} &= \sqrt{3} a^2 \\ \text{slant height} &= \frac{\sqrt{3}}{2} a \\ \text{slant edge} &= a \end{aligned}$$

GoCareer.in

14) find the vol. of a tetrahedron whose height is $2\sqrt{3}$

$$\begin{aligned} \frac{\sqrt{2}}{\sqrt{3}} a &= 2\sqrt{3} \\ a &= \frac{6}{\sqrt{2}} \\ \text{vol.} &= \frac{\sqrt{2}}{12} \times \frac{6 \times 6 \times 6}{\sqrt{2} \times \sqrt{2} \times \sqrt{2}} = \frac{18}{2} = 9 \text{ cm}^3 \end{aligned}$$

15) find the vol. of a pyramid w/c is based on an equilateral Δ of side 4 cm. If its slant height is 2 times of its height

$$r = \frac{4}{2\sqrt{3}} = \frac{2}{\sqrt{3}} \text{ (Base length)}$$

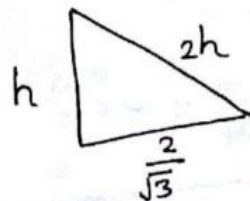
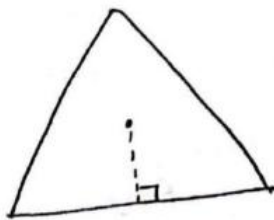

$$\begin{aligned} h^2 + \frac{4}{3} &= 4h^2 \\ 3h^2 &= \frac{4}{3} \\ h^2 &= \frac{4}{9} \\ h &= \frac{2}{3} \end{aligned}$$

$$\text{vol.} = \frac{1}{3} \times \frac{\sqrt{3}}{4} \times 4 \times 4 \times \frac{2}{3} = \frac{8\sqrt{3}}{9}$$

- ⑩ The base of a pyramid is equilateral Δ of side 4 cm. if its total surface area is 3 times its volume. find the vol. of pyramid.

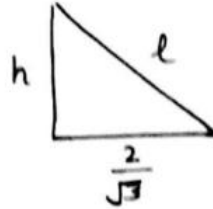
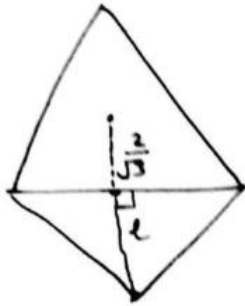

$$l^2 = h^2 + \frac{4}{3}$$

$$T.S.A = 3 \times V$$

$$\frac{1}{2} \times 4 \times 2 \times l + \frac{\sqrt{3}}{4} \times 4 \times 4 = 3 \times \frac{1}{3} \times \frac{\sqrt{3}}{4} \times 4 \times 4 \times h$$

$$6l + 4\sqrt{3} = 4\sqrt{3}h$$

$$3l + 2\sqrt{3} = 2\sqrt{3}h$$

$$3l = 2\sqrt{3}(h-1)$$

square

$$9l^2 = 12(h^2 + 1 - 2h)$$

$$9\left(h^2 + \frac{4}{3}\right) = 12(h^2 + 1 - 2h)$$

$$9h^2 + 12 = 12h^2 + 12 - 24h$$

$$3h^2 = 24h$$

$$\boxed{h = 8}$$

$$\text{Vol.} = \frac{1}{3} \times \frac{\sqrt{3}}{4} \times 4 \times 4 \times 8 = \frac{32\sqrt{3}}{3} \quad \underline{\underline{\text{Ans.}}}$$

② find the T.S.A of a pyramid w/c is based on rectangle of length 18 cm and breadth 10 cm. & height 12 cm.

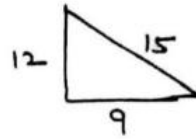
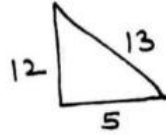
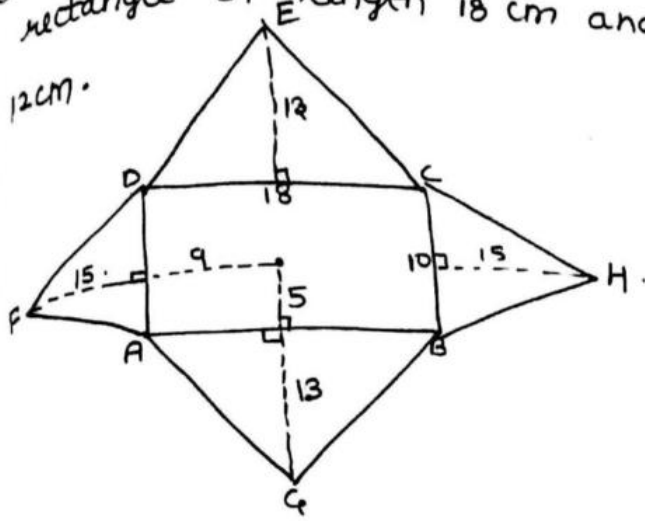

$$2 \times \frac{1}{2} \times 18 \times 13 + 2 \times \frac{1}{2} \times 10 \times 15$$

Ar. ΔDEC &
Ar. ΔABG

Ar. ΔFDA &
Ar. ΔBCH .

GoCareer.in

$$\Rightarrow 234 + 150 = 384 = \text{L.S.A}$$

$$\begin{aligned} \text{T.S.A} &= \text{L.S.A} + 18 \times 10 \\ &= 384 + 180 = 564 \text{ cm}^2 \end{aligned}$$

③ The height of a conical tank is 9 m. A vertical pole of 6 m height is placed 4 m away from its centre such that it touches its surface. ~~vertical~~ find the L.S.A of the tent.

④ A cone is cut parallel to its base in such a way that height of the two parts is same. find the ratio of vol. of these two parts.

- (20) A cone is cut parallel to its base in such a way that the height of each part is same. find the ratio of vol. of these parts.
- (21) A cone is cut parallel to its base in such a way that the volume of the smaller cone is $\frac{1}{729}$ times of bigger cone. find the height of the smaller cone if the cone is cut 40cm above the base.
- (22) The base radius and height of a cone are 5cm and 25cm. if the cone is cut parallel to its base at a height of h from the base. if the vol. of frustum is 110 cm^3 . find the ~~vol~~ radius of the smaller cone.

~~(18) The side of a right angle is 15~~

Soln

(18)



$$\frac{3}{9} = \frac{4}{R}$$

$$R = 12$$

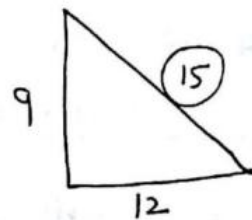
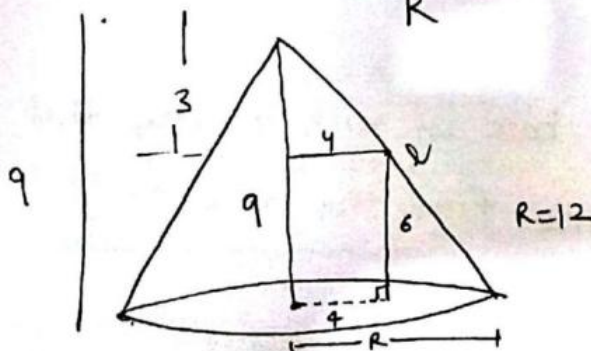
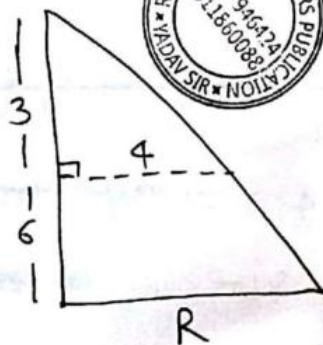

$$\text{vol} = \frac{1}{3} \times \frac{22}{7} \times 12 \times 12 \times 9 = 432\pi$$

$$\text{L.S.A} = \frac{22}{7} \times 12 \times 15 = 180\pi$$

GoCareer.in

#

CONE

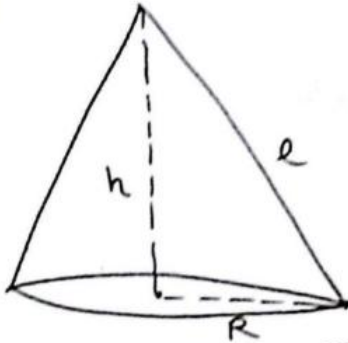

$$V = \frac{1}{3} \pi r^2 h$$

$$\text{L.S.A} = \pi r l$$

$$\text{T.S.A} = \pi r (r + l)$$



19

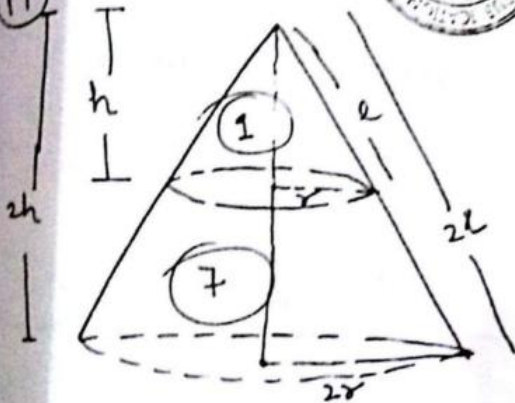

small cone	larger cone
$V = \frac{1}{3} \times \pi r^2 h$	$\frac{1}{3} \pi (2r)^2 \times 2h$
r^2	$4r^2 \times 2$
1	8

Ratio of vol. of two parts = $\frac{1}{7}$

#

if a cone is cut parallel to its base then

	smaller cone	:	larger cone
height / slant height / radius.	x	:	y

volume	→	x^3	:	y^3
--------	---	-------	---	-------

(20)

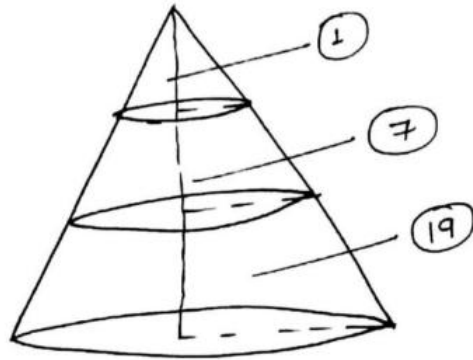

smaller medium larger
 height \rightarrow 1 : 2 : 3
 vol. \rightarrow 1 : 8 : 27

vol. of three parts = 1, 7, 19 Ans.

(21)

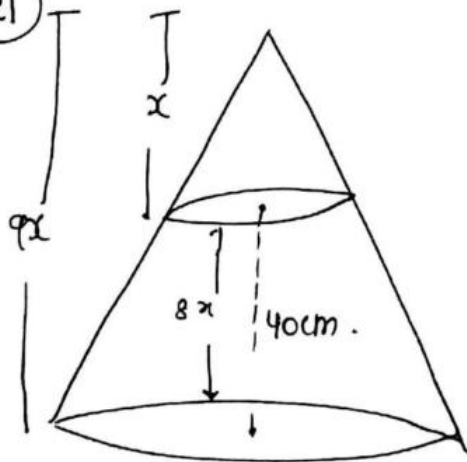

small larger
 vol. 1 729
 H/radius 1 : 9

$$8x = 40$$

$$x = 5$$

Height of smaller cone = 5 cm.

(22)

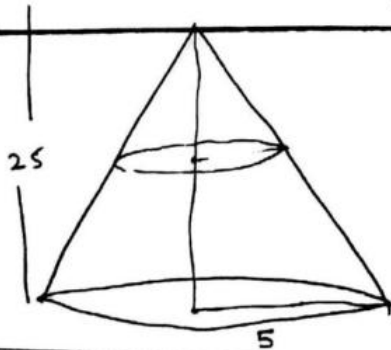

$$\frac{V_{\text{cone}}}{V_{\text{frustum}}} = \frac{\frac{1}{3} \times \frac{22}{7} \times 25 \times 25}{110}$$

$$\frac{V_{\text{cone}}}{V_{\text{frustum}}} = \frac{125}{21}$$

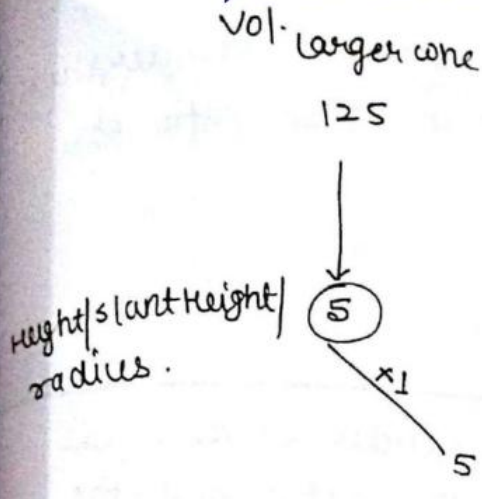

\therefore Radius of smaller

cone = $\sqrt[3]{104}$ Ans.

23) The side of a right angle Δ are 15, 20 & 25 cm. if the Δ is revolve around its hypotenuse, then find the vol. and T.S.A of the formed figure.

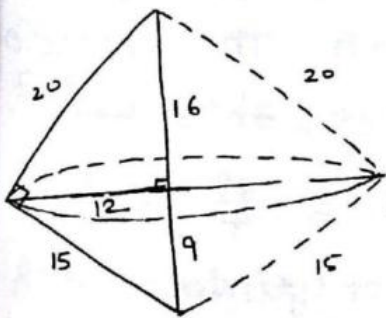

Vol. of such figure = $\frac{1}{3} \pi \left[\frac{P \times B}{H} \right]^2 \times H$

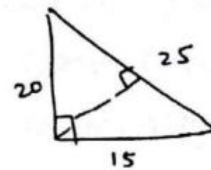

H \rightarrow Hypotenuse.

$\frac{1}{3} \times \frac{22}{7} \times \frac{4}{1} \times 12 \times 25 = 1200\pi$

$\frac{20 \times 15}{25} = 12$

T.S.A = $\pi r l_1 + \pi r l_2 \Rightarrow \pi r (l_1 + l_2) \Rightarrow \pi \times 12 (20 + 15) = 420\pi$

24) $a = 12$

$V = \frac{\sqrt{2}}{12} \times \frac{1}{2} \times 12 \times 12 = 144\sqrt{2}$

Ans

\rightarrow if the length of each side of regular tetrahedron is 12 cm, find the vol.?

25) The length of diagonal of a cube with volume

729 cm^3 is \rightarrow

$a^3 = 729$

$a = 9$

$D = \sqrt{3} a = 9\sqrt{3}$ Ans

6) The ratio of radii of two right circular cylinders is 2:3 and their heights are in the ratio 5:4. Then ratio of their curved surface area is →

$$\cancel{2\pi} (2) \times 5 : \cancel{2\pi} (3) \times 4$$

$$5 : 6$$

7) If the radius of right circular cylinder is doubled and the height is halved, then the ratio b/w the new volume and the previous volume of the cylinder is →

$$\pi r^2 \times 2h : \pi 4r^2 \times h$$

$$1 : 2$$

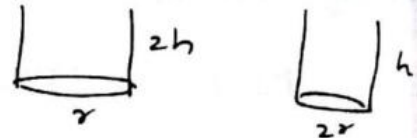

8) A solid cylinder has total surface area of 462 sq. cm. curved surface area is 1/3rd of its T.S.A. The volume of the cylinder is -

$$\cancel{2\pi} r h \times 3 = 2\pi r (r+h)$$

$$3h = r+h$$

$$2h = r$$

$$2\pi r (h+r) = 462$$

$$2\pi \times 2h (h+2h) = 462$$



$$4 \times \frac{22}{7} \times 3h^2 = 462$$

$$h^2 = \frac{49}{4} \Rightarrow h = \frac{7}{2}$$

$$\text{vol. of cylinder} = \pi r^2 h$$

$$= \frac{22}{7} \times 4h^2 \times h$$

$$= \frac{22}{7} \times 4 \times \frac{49}{4} \times \frac{7}{2}$$

$$= 539 \text{ cm}^3 \text{ Ans}$$

9) The height of a right circular cylinder is 6 m and three times the sum of the areas of its two end faces is equal to twice the area of its curved surface. The radius of its base, in metre is ?

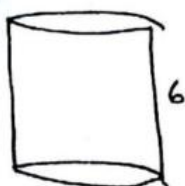

$$2\pi r^2 \times 3 = (2\pi r \times 6) \times 2$$

$$r = 4$$

- (30) The ratio of height and diameter of a right circular cone is 3:2 and its vol. is 1078 cc, then its height is



$$\frac{1}{3} \times \frac{22}{7} \times x^2 \times 3x = 1078 \cdot 49$$

$$x^3 = 49 \times 7$$

$$x = 7$$

$$\text{Height} = 3x \Rightarrow 3 \times 7 = 21 \text{ cm } \underline{\underline{\text{Ans}}}$$

- (31) In a circular sheet of paper of radius 10 cm, a sector of 40% area is removed and the remaining part is used to make a conical surface. find the volume of the conical surface.

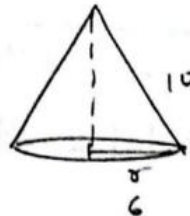
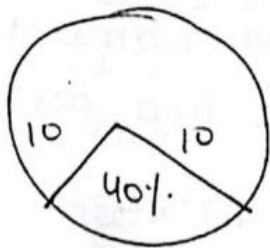

$$\frac{60}{100} \times \pi \times 10^2 \times \frac{10}{10} = \pi r^2 \left(\frac{4}{6}\right)$$

$$r = 6$$

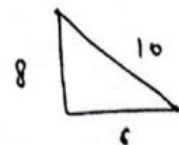

$$\text{Height} = 8$$

$$\text{Vol.} = \frac{1}{3} \times \frac{22}{7} \times 6^2 \times 8 = 96\pi$$

- (32) A right angled sector of radius r cm is rolled up into a cone in a way that two bounding radii are joined together. find the C.S.A of the cone →

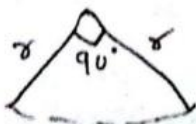

$$\text{C.S.A} = \frac{90}{360} \times \pi r^2 = \frac{\pi}{4} r^2$$

CLASS
62

GoCareer.in

⊕

Sphere

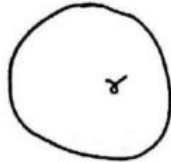

$$V = \frac{4}{3} \pi r^3$$
$$L.S.A = 4\pi r^2$$
$$T.S.A = 4\pi r^2$$

⊕

Hemisphere

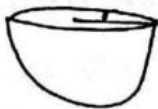

$$V = \frac{2}{3} \pi r^3$$
$$L.S.A = 2\pi r^2$$
$$T.S.A = 3\pi r^2$$

33) A sphere is cut in two parts along its diameter. find the total surface area of these two parts

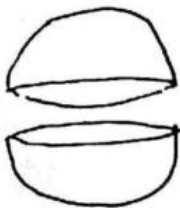

$$4\pi r^2 + \pi r^2 + \pi r^2 = 6\pi r^2$$

if sphere is cut into n parts, then

$$T.S.A \text{ of } n \text{ parts} = 4\pi r^2 + n\pi r^2$$

34)

The T.S.A of a solid hemisphere is 1848 sq. cm. then the diameter of the same is -

$$3 \times \frac{22}{7} \times r^2 = \frac{64}{28}$$

$$r^2 = 7 \times 7 \times 4$$

$$r = 7 \times 2 = 14$$

$$D = 28 \text{ cm.}$$

- 35) A cylinder and a cone have equal radii of their bases and equal heights. If their curved surface area are in the ratio 8:5, the ratio of their radius & height is →

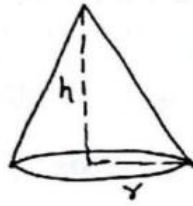
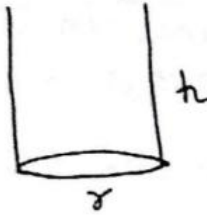

$$\frac{2\pi r h}{\pi r \sqrt{h^2 + r^2}} = \frac{8}{5}$$

$$\frac{4h^2}{h^2 + r^2} = \frac{64}{25}$$

$$\frac{h}{r} = \frac{8}{5} = \frac{4}{3}$$

GoCareer.in

- 36) A solid cone of height 9 cm with diameter of its base 18 cm is cut from a wooden solid sphere of radius 9 cm. The percentage of wood wasted is :

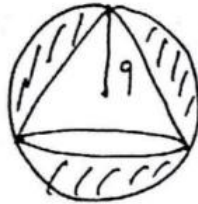
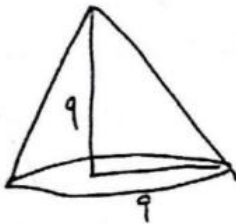

$$\frac{\frac{1}{3} \pi (9)^2 \times 9}{\frac{4}{3} \pi (9)^3}$$

$$= \frac{1}{4} \begin{matrix} \text{--- cone volume} \\ \text{--- sphere vol.} \end{matrix}$$

$$\therefore \frac{3}{4} \times 100 = 75\% \text{ wasted.}$$

- 37) From a solid cylinder of height 10 cm and radius of the base 6 cm, a cone of same height and same base is removed. Volume of the remaining solid is :-

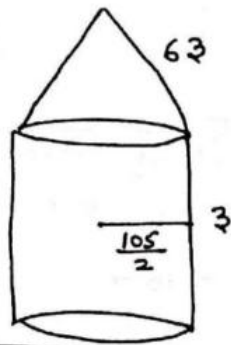

$$2\pi \left(\frac{105}{2}\right) \times 3 + \pi \left(\frac{105}{2}\right) \times 63$$

$$\frac{22}{7} \left(\frac{105}{2}\right) [6 + 63]$$

$$\parallel \frac{22}{7} \times \frac{15}{2} \times 69 = 11385 \text{ वर्ग मी.}$$

- 41) A solid is hemispherical at the bottom and conical above if the surface areas of the two parts are equal then the ratio of radius and height of its conical part is :-

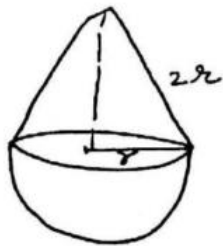

$$\pi r l = 2\pi r^2$$

$$l = 2r$$

$$h = \sqrt{(2r)^2 - r^2} = \sqrt{3}r$$

$$r : \sqrt{3}r$$

$$1 : \sqrt{3}$$

GoCareer.i



- 42) A maximum size sphere is cut from a hemisphere of radius r . Find the ratio of volumes of hemisphere to sphere :-

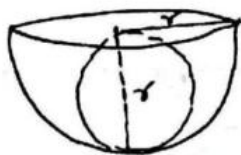

$$\frac{2}{3} \pi r^3 : \frac{4}{3} \pi \left(\frac{r}{2}\right)^3$$

$$1 : \frac{1}{4}$$

$$4 : 1$$

- 43) In a cylindrical vessel of diameter 24 m filled up with sufficient quantity of water, a solid spherical ball of radius 6 cm is completely immersed. Then the increases in height of water level is :-

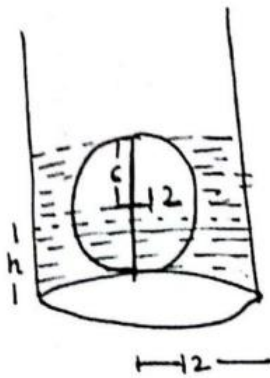

$$\pi (12)^2 \times 12 - \frac{4}{3} \pi (6)^3 = \pi (12)^2 \times h$$

$$12^2 \times 12 - \frac{4}{3} \times 6 \times 6 \times 6 = (12)^2 \times h$$

$$12 - 2 = h$$

$$h = 10 \text{ cm}$$

\therefore \uparrow in water level
 $= 12 - 10 = 2 \text{ cm.}$

44) ~~A cone, a hemisphere~~

A cylindrical can whose base is horizontal is of internal radius 3.5 cm contain sufficient water so that when a solid sphere ^{of max. size} is placed, water just immersed it. Calculate the depth of water in the can before the sphere was put.

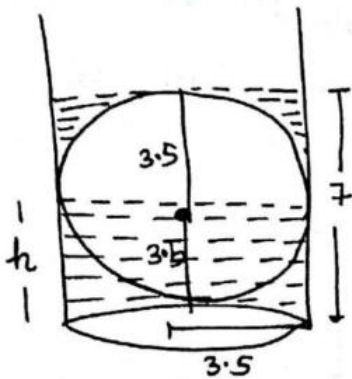

$$\pi (3.5)^2 \times 7 - \frac{4}{3} \pi (3.5)^3 = \pi (3.5)^2 \times h$$

$$7 - \frac{4}{3} \times \frac{3.5}{2} = h$$

$$7 - \frac{14}{3} = h$$

$$h = \frac{7}{3} \quad \underline{\text{Ans.}}$$

45) The base radius and slant height of a conical vessel is 3cm and 6cm respectively. Find the volume of sufficient water in the vessel such that when a sphere of radius 1 cm is placed into it, water just immersed it.

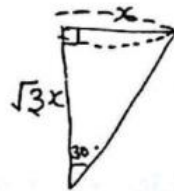
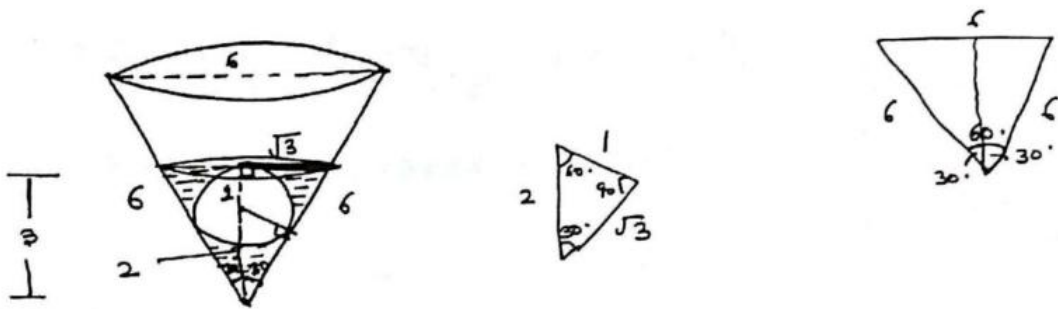

$$\sqrt{3}x \rightarrow 3$$

$$x \rightarrow \frac{3}{\sqrt{3}} = \sqrt{3}$$

$$\frac{1}{3} \pi (\sqrt{3})^2 \times 3 - \frac{4}{3} \pi (1)^3$$

$$3\pi - \frac{4}{3} \pi$$

$$\frac{5}{3} \pi \quad \underline{\text{Ans}}$$

GoCareer.in

46) A cone, a hemisphere and a cylinder stand on equal base and have the same height. Their vol. are in the ratio -

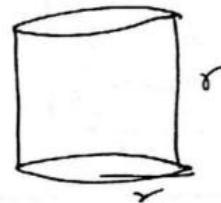

$$\frac{1}{3} \pi r^2 \cdot r : \frac{2}{3} \pi r^3 : \pi r^2 \cdot r$$

$$\frac{1}{3} : \frac{2}{3} : 1$$

$$1 : 2 : 3 \quad \underline{\text{Ans}}$$

47) The height of a cone, cylinder and hemisphere are equal. If their radii are in the ratio 2:3:1, then the ratio of their volumes is :-

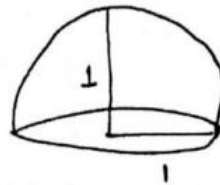
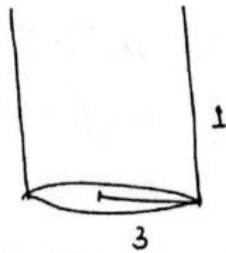
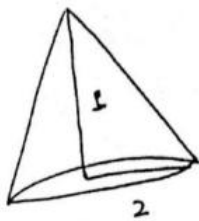

$$\frac{1}{3} \times \pi \times 2^2 \times 1 \quad : \quad \pi (3)^2 \times 1 \quad : \quad \frac{2}{3} \pi (1)^2 \times 1$$

$$\frac{4}{3} \quad : \quad 9 \quad : \quad \frac{2}{3}$$

$$4 \quad : \quad 27 \quad : \quad 2 \quad \underline{\text{Ans.}}$$

48) A cylinder is kept inside the cube in such a way that it touches all side of the cube and a cone is further placed inside the cylinder and the base & height of all the three are same. find the ratio of their volumes.

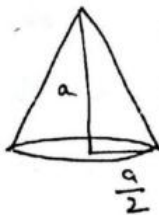
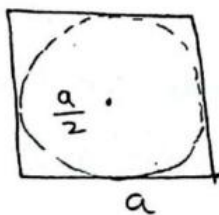

$$a^3 \quad : \quad \pi \left(\frac{a}{2}\right)^2 \times a \quad : \quad \frac{1}{3} \pi \left(\frac{a}{2}\right)^2 \times a$$

$$12 \quad : \quad 3\pi \quad : \quad \pi$$

$$6 \times 12 \quad : \quad 3 \times \frac{22}{7} \quad : \quad \frac{22}{7}$$

$$42 \quad : \quad 33 \quad : \quad 11 \quad \underline{\text{Ans.}}$$

- (49) if a conical cavity is drilled out into a circular cylinder of height 15 cm and base radius 8 cm. the height and base radius of conical cavity is same. find the volume and T.S.A of the remaining solid.

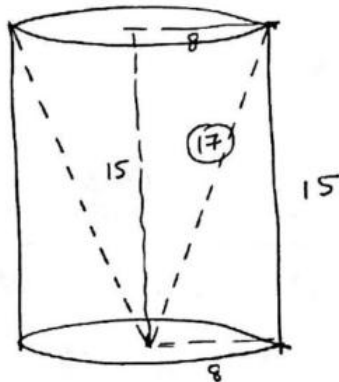

vol. of remaining solid =

$$\frac{2}{3} \times \frac{22}{7} \times 8 \times 8 \times 15$$

$$640 \pi \text{ cm}^3$$



$$\begin{aligned} \text{T.S.A of remaining solid} &= 2\pi(8) \times 15 + \pi(8)^2 + \pi(8) \times 15 \\ &= 440\pi \end{aligned}$$

- (50) The base radius and height of a cylinder are 7 cm & 25 cm. 2 conical cavity of radius 5 cm and height 12 cm are drilled out on the both ends of the cylinder find the volume and T.S.A of the remaining solid.

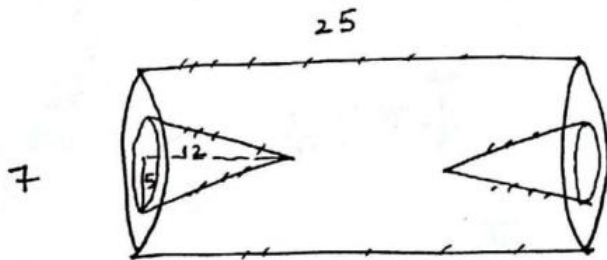

vol. of remaining solid =

$$\pi(7)^2 \times 25 - 2 \times \frac{1}{3} \pi(5)^2 \times 12$$

$$\pi(1225 - 200) = 1025\pi$$

$$\begin{aligned} \text{T.S.A} &= \underbrace{2\pi(7) \times 25}_{\text{cylinder}} + \underbrace{2\pi(5) \times 12}_{2 \text{ cavity}} + \left[2\pi(7^2 - 5^2) \right] \\ &= 2 \times 24\pi \end{aligned}$$

↓ दोनों ends पर बचा हुआ area.

$$= 528\pi \text{ Ans}$$

The height of a metallic hollow cylinder is 14 cm and the diff b/w its inner curved surface area & outer C.S.A is 44 cm^2 . if the cylinder is made up of volume 99 cm^3 metal. find its inner & outer radius.

Outer diameter of a 20 cm long pipe is 25 cm. if the thickness of the metal in the pipe is 1 cm. find the T.S.A of the pipe.

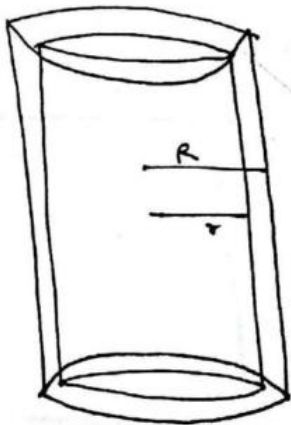

$$\Rightarrow 2\pi R \times 14 - 2\pi r \times 14 = 44$$

$$2 \times \frac{22}{7} \times 14 [R - r] = 44$$

$$[R - r] = \frac{1}{2}$$

$$\Rightarrow \pi R^2 \times 14 - \pi r^2 \times 14 = 99$$

$$\frac{22}{7} \times 14 (R^2 - r^2) = 99$$

$$44(R - r)(R + r) = 99$$

$$44 \times \frac{1}{2} (R + r) = 99$$

$$(R + r) = \frac{9}{2}$$

$$R - r = \frac{1}{2}$$

$$R + r = \frac{9}{2}$$

$$2R = 5$$

$$R = \frac{5}{2}$$

$$r = 2$$

GoCareer.in

52

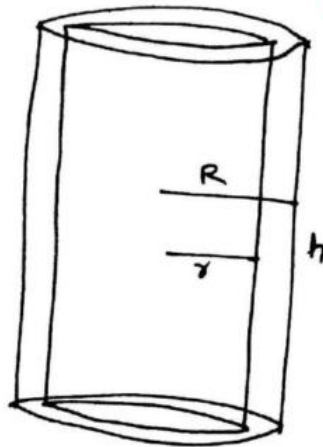

$$2\pi Rh + 2\pi rh + 2\pi [R^2 - r^2]$$

$$2\pi h [R+r] + 2\pi [(R+r)(R-r)]$$

$$2\pi [R+r] [h+R-r]$$

$$2\pi (R+r) (h+t)$$

$$2 \times \frac{22}{7} (12.5 + 11.5) (20 + 1)$$

$$2 \times \frac{22}{7} \times 24 \times 21 = 44 \times 72 = 3168$$

53

$$\begin{aligned} \text{T.S.A of the Hollow cylinder} &= \\ &2\pi (R+r) (h+t) \end{aligned}$$

CLASS
63

53) A room 8m long, 6m broad and 3m high have 2 windows of $1\frac{1}{2}m \times 1m$ and a door of $2m \times 1\frac{1}{2}m$. find the cost of papering the 4 walls with paper 50cm wide at the rate of 25 paise per metre.

54) find the length of wire of radius 0.25 cm w/c can completely cover the surface of a cylinder whose height is 1.2 m and base radius 14 cm.

$$\begin{aligned} \text{Area of 4 walls to be papered} &= 2(L+b)h \\ &= 2 \times 14 \times 3 = 84 \\ 84 - 6 &= 78 \text{ m}^2 \end{aligned}$$

$2 \times \left[\frac{3}{2} \times 1 \right]$ → windows Area
 $2 \times \frac{3}{2}$ → door Area



$$78 \text{ m}^2 = l \times \frac{1}{2}$$

length of paper = 156 metre

$$\text{cost of papering the wall} = 156 \times \frac{25}{100} = 39 \text{ Rs.}$$

54

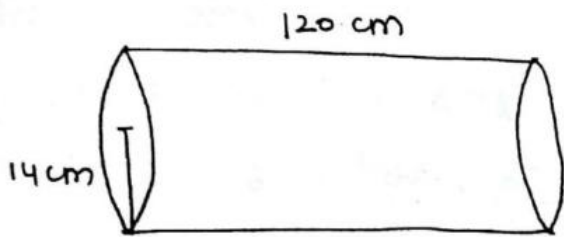

$$\frac{2 \times \frac{22}{7} \times 7 \times 120}{7} = \frac{l \times 0.5}{10}$$

↑ surface area of cylinder ↑ area of wire

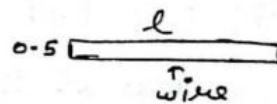

* wire radius = 0.25
 ∴ width of wire = diameter of wire = 0.25 × 2 = 0.5

$$\Rightarrow 88 \times 120 \times 2 = l$$

$$l = 21120 \text{ cm. } \underline{\text{Ans.}}$$

OR

$$\frac{120}{0.5} = 240 \text{ rounds of wire}$$

$$\Rightarrow \frac{2 \times \frac{22}{7} \times 7 \times 240}{7} = 21120 \text{ cm.}$$

- (55) find the length of the string wound on a cylindrical tank whose base diameter and height are $5\frac{1}{11}$ cm and 48 cm. The string makes exactly 4 complete turns around the cylinder while its two ends touch the top and bottom of the tank.

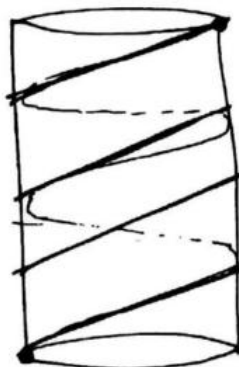

$$d = \frac{56}{11}$$

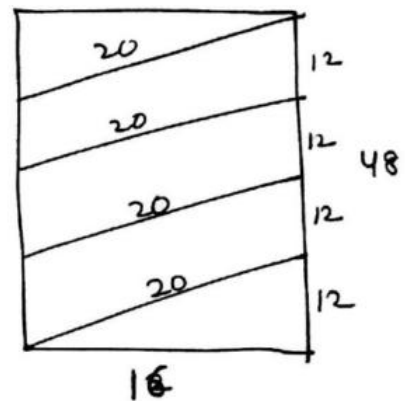

2πr

$$8 \frac{56}{11} \times \frac{22^2}{7} = 16$$

length of string = $20 + 20 + 20 + 20 = 80$. (approx.)

- (56) Two-third part of an aquarium is full of water. when we tilt the aquarium in such a way that the water becomes diagonal shape, in this process 93.5 L of water is flown out. find the capacity of the aquarium?

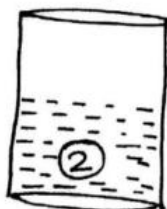

let capacity = 3 L
filled = $\frac{2}{3} \times 3 = 2$ L

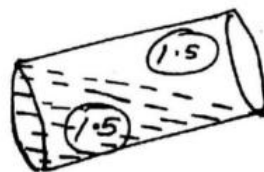

$$2 - 0.5 = 0.5 \rightarrow 93.5$$

$$1 \rightarrow \frac{93.5}{0.5} = 187$$

$$\text{Capacity} = 3 \times 187 \text{ L}$$

57) water flowing at the rate of 5 km/Hr through a pipe of radius 7 cm into a rectangular tank w/c is 100 m long and 44 m wide. In what time the water level will rise by 14 cm.

58) The water in a rectangular reservoir having 80m x 60m x 6.5 m dimension. In what time can the water be emptied by a pipe of w/c the cross-section is a square of side 20 cm. If the water run through the pipe at the rate of 15 km/Hr.

59) A rectangular tank of dimension 225 m x 162 m at the base, with what speed must water flow into it through a rectangular pipe of base 40m x 60 m so that the water level may be ↑ by 20 cm in 5 hours

60) If the length of a rectangular pipe is 3 times of its breadth and 5 times of its height. If its vol. is 14400 cm³, find its T.S.A ?

57

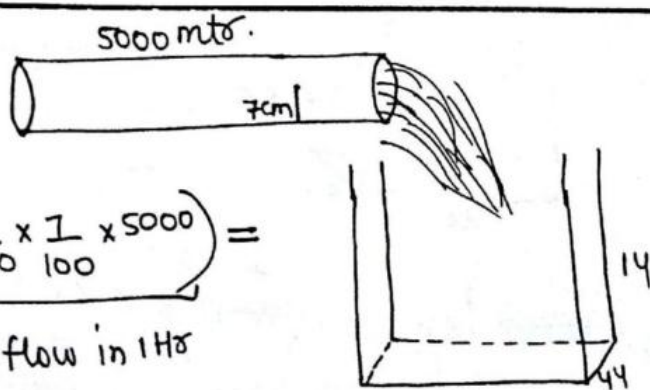

$$\pi \left(\frac{22}{7} \times \frac{7}{100} \times \frac{7}{100} \times 5000 \right) =$$

↑
water flow in 1 Hr

$$\frac{100 \times 44 \times 14}{100}$$

↓
vol. of pipe

vol. of pipe

$$n \left(\frac{22}{7} \times \frac{7}{100} \times \frac{7}{100} \times 5000 \right) = \frac{100 \times 44 \times 44}{100}$$

$n = 8$ Hours.

(59)

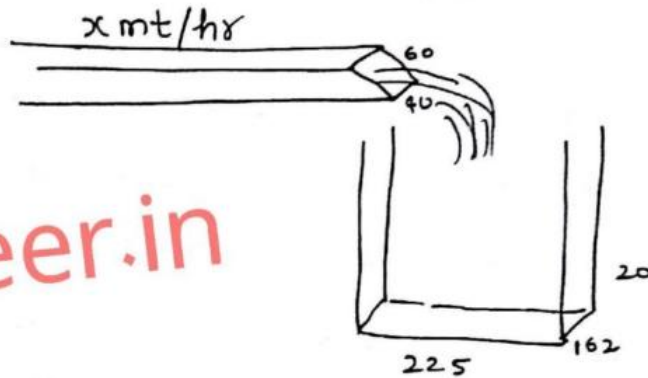

GoCareer.in

$$\frac{x}{25} \times \left[\frac{60 \times 40}{100 \times 100} \times x \right] = \frac{225 \times 162 \times 20}{100 \times 100}$$

↑
1 Hr vol.

$x = 25 \times 9 \times 27 = 6075$ m.

(58)

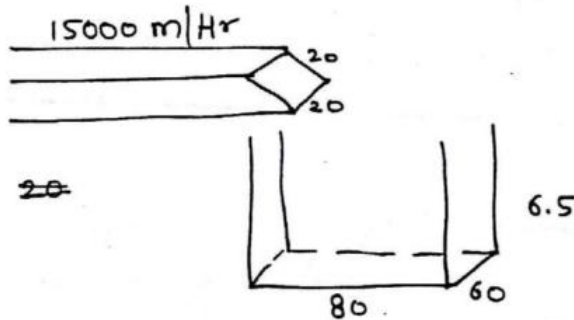

$$\left[\frac{20}{100} \times \frac{20}{100} \times 15000 \right] \times n = \frac{80 \times 60 \times 6.5}{100}$$

$n = 52$ Hours.

60

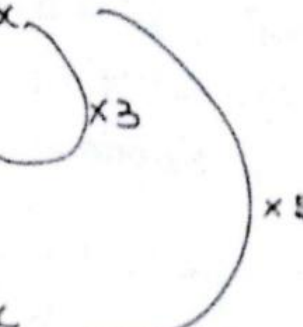
$$\begin{aligned} L &= 15x \\ B &= 5x \\ H &= 3x \end{aligned}$$

GoCareer.in

$$15x \times 5x \times 3x = 14400$$

4800

$$x = 4$$

$$\text{Surface Area} = 2(L+B) \times h.$$

$$2(60+20) \times 12 = 1920$$

61) The weight of a cubic metre metal is 480 kg. It is melted and cast into a square rod of 4m length. A solid cube of maximum size is taken out from one end. Find the weight of the solid cube?

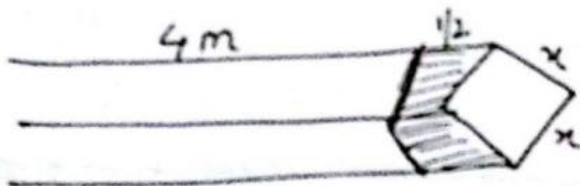

$$x \times x \times x \times 4 = 1$$

$$x^2 = \frac{1}{4}$$

$$x = \frac{1}{2}$$

(Vol. of square rod = Vol. of metal)

$$\text{Vol. of cube} = \left(\frac{1}{2}\right)^3 = \frac{1}{8} \text{ m}^3$$

$$\text{weight} = \frac{1}{8} \times 480 = 60 \text{ kg}$$

62) A well of 14 m base radius is digged upto a depth of 10 m & a 7 m wide platform was made around the well. find the height of platform?

63) In the middle of a rectangular field of length 35 m and breadth 15.4 m, a bit of length 5.5 m, breadth 4 m and depth 2.5 m was dug. and the earth taken out was spread over rest of the ground. How much the level of the ground will be increased?

62

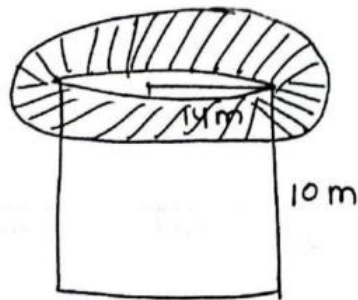

$$\text{Vol. of earth} = \frac{22}{7} \times 14 \times 14 \times 10.$$

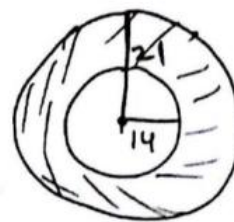

→ It would be prism like

$$\frac{22}{7} \times 14 \times 14 \times 10 = \pi [21^2 - 14^2] \times h$$

$$14 \times 14 \times 10 = (21+14)(21-14) \times h$$

$$2 \times 14 \times 14 \times 10 = 535 \times \pi \times h$$

$$h = 8$$

GoCareer.in

63

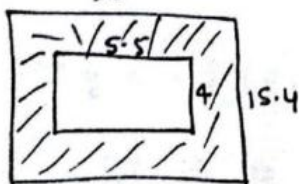

↑
would be prism

$$\text{Vol. of earth} = 5.5 \times 4 \times 2.5$$

$$(35 \times 15.4 - 5.5 \times 4) \times h = 5.5 \times 4 \times 2.5$$

$$(539 - 22) \times h = 55$$

$$517h = 55$$

$$h = 9.4 \text{ m}$$

- 64) A conical tent is required to accommodate 5 people and each person needs 16 m^2 square of space on the ground and 100 m^3 air to breathe. Find the height of the conical tent?

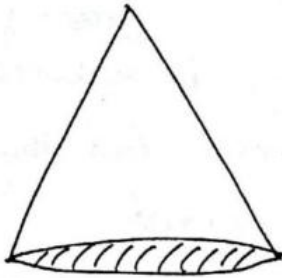

$$\text{Base Area} = \pi r^2 = 5 \times 16$$

$$\frac{1}{3} \pi r^2 h = 5 \times 100$$

$$\frac{1}{3} \times 5 \times 16 \times h = 500$$

$$\frac{1}{3} \times \frac{4}{8} \times h = \frac{25}{50}$$

$$h = \frac{75}{4}$$

- 65) What is the semi-vertical angle of the cone whose L.S.A is double of the base area.

- 66) Find the no. of cones of semi-vertical angle α and having r as the radius of the mid section w/c can be made out of the cylinder of base radius r and height $2r \cot \alpha$.

- 67) Find the radius of maximum size sphere w/c can be inscribed in a cone whose base radius and height are 6 cm and 8 cm.

- 68) The base ~~area~~^{radius} and height of a road roller are 0.7 cm and 10 cm respectively. When it revolves 1200 times then it levels only 88% area. Find the cost of leveling the whole ground at the rate of 6.75 Rs per cm^2 .

CLASS
64

- (69) The height of a cylinder is 2 cm, find its base radius if 6 cm is added either in radius or height gives same change in the volume. (अंतर $\frac{1}{4}$ हो गया)
- (70) A cylinder whose area of the base is reduced to $\frac{1}{9}$ and its height is increased to 6 times. find the increase or decrease in the c.s.A of the cylinder.
- (71) The radius of a cylinder is 10 cm and its height is 4 cm. How much cm does we add either in radius or in height to get the same change in the vol.
- (72) Rs 1000 is spent on the maintenance of a rectangular ground. When the cost per metre is 25 paise. The width of the ground is 50 m. if the length of the ground is increased by 20 m, then find the new cost of the maintenance.
- (73) 2 cm of rain has fallen on a square km of length 50% of the water was stored in a tank of dimension 100 m x 10 m. Find the \uparrow in the water level in tank
- (74) if P is the height of a tetrahedron and length of each side is ~~2A~~ 2A. find the value of $3P^2$
- (75) A prism based on a trapezium with parallel sides of length 8 cm and 14 cm have a distance of 14 cm between its two parallel lines. find the height

(76) if h , c and v are the height, C.S.A, and vol respectively of a cone. find

$$3\pi v h^3 - c^2 h^2 + 9v^2$$

(77) A person requires 4 m^2 of space on the ground and 20 m^3 vol. to breath. What is the height of a conical tent if 11 person has to be accomodated in the tent.

(78) How many smaller cylinder of height & radius 3.5 cm can be made from a larger cylinder of height 14 cm and radius 7 cm

(79) The length of a rectangular metallic sheet is 20 m and width is 14 cm . A water tank of maximum vol. possible is made from the sheet of height 2 cm . find the vol. of the tank.

(80) Few people dive in a swimming pool of dimension $20 \text{ m} \times 10 \text{ m}$. Due to this the water level rises by 2 m . If one person displace 1 cubic m of water find the no. of people who are diving.

(81) A rectangular sheet of length 44 cm and breadth 18 cm was rolled along its length (length को मोला है) to form a cylinder. find the vol. of the formed cylinder.

(82) The capacity of two hemispherical bowls is 6.4 l and 21.6 l . find the ratio of their C.S.A.

- 83) The length of a swimming pool is 20 m and width 10 m. Its depth in starting is 4.5 m w/c reaches upto 7.5 m in the other end. find the vol. of the pool.

Solutions

65)

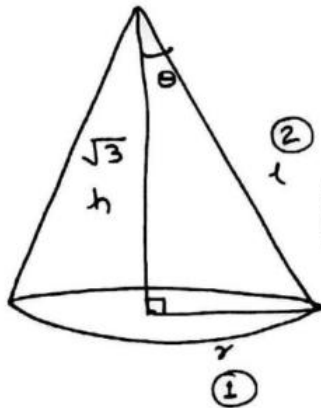

$$\pi r l = 2 \pi r^2$$

$$\frac{l}{r} = \frac{2}{1}$$

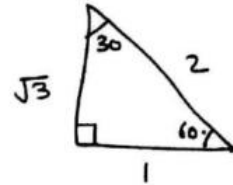

$\therefore \theta = 30^\circ$ Ans.

66)

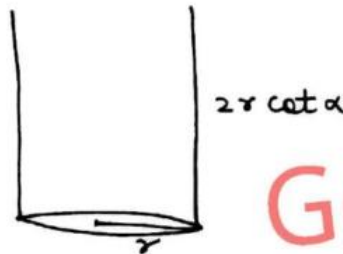
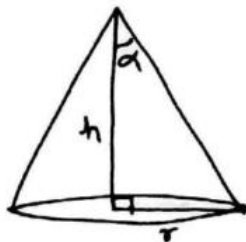

GoCareer!

$$\frac{h}{r} = \cot \alpha$$

$$h = r \cot \alpha$$

$$\pi r^2 \times 2r \cot \alpha = n \times \frac{1}{3} \pi r^2 \times h$$

$n = 6$ Ans.

67)

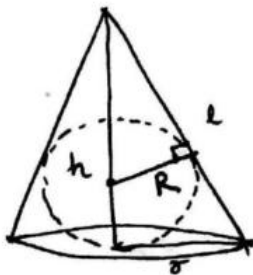

$$\text{Radius of sphere} = \frac{h \times r}{h + r}$$

$$= \frac{8 \times 6}{10 + 6} = \frac{48}{16} = 3 \text{ cm. } \underline{\underline{An}}$$



68

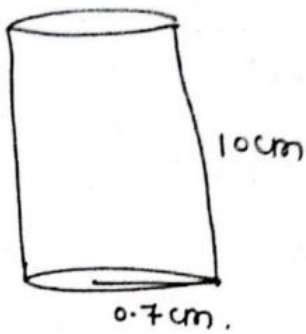

एक बार में मल्ले.
धुमेगा तो वो अपने
Surface Area जितना
area cover करेगा।

$$2 \times \frac{22}{7} \times 0.7 \times 10 \times 1200 = A \times \frac{88}{100}$$

$$A = 60,000 \text{ cm}^2$$

$$\text{cost} = 60,000 \times 6.75 = 405,000 \text{ Rs.}$$

70

$$\pi R^2 = 9$$

(R=3)

$$\pi r^2 = 1$$

(r=1)

Surface Area

$$2\pi R H = 3 \times 1 = 3$$

height

$$2\pi r h = 1 \times 6 = 6$$

height

x2 times

S.A. becomes 2 times.

71

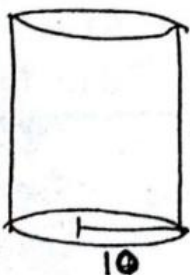

$$\begin{aligned} \text{Vol} &= \pi (10)^2 \times 4 \\ &= 400\pi \end{aligned}$$

if Add 5 in radius then.

$$\text{Vol} = \pi \times 15^2 \times 4 = 900\pi$$

if Add 5 in height then

$$\text{Vol} = \pi \times 10^2 \times 9 = 900\pi.$$

∴ The no. is 5. Ans

options are -

A) 5

B) 16

C) 25

D) 36.

OR

$$\pi(10+x)^2 \times 4 = \pi(10)^2(4+x)$$

$$(100+x^2+20x)4 = 100(4+x)$$

$$400 + 4x^2 + 80x = 400 + 100x$$

$$4x^2 = 20x$$

$$4x = 20$$

$$x = 5 \quad \text{Ans.}$$

GoCareer.in

(69)

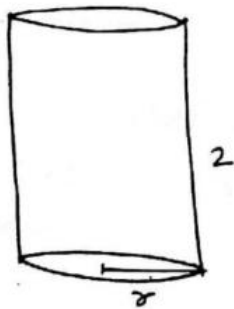

$$\pi(r+6)^2 \times 2 = \pi r^2(6+2)$$

$$(r+6)^2 \times r = r^2(8)$$

squaring

$$\sqrt{(r+6)^2 \times r} = \sqrt{r^2(8)}$$

$$r+6 = 2r$$

$$r = 6$$

(72)

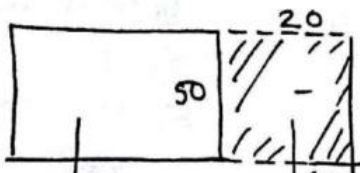

1000 Rs

250 Rs

$50 \times 20 = 1000 \text{ m}^2$ (Area increase due to \uparrow in length)

increase in cost = $1000 \times \frac{25}{100} = 250 \text{ Rs}$

Now cost = $1000 + 250 = 1250 \text{ Rs.}$

73

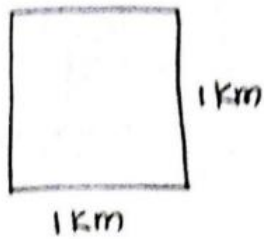

Area = 1000×1000

$$\underbrace{1000 \times 1000 \times \frac{2}{100}}_{\substack{\text{इतना पानी गिरा} \\ \text{है}}} \times \underbrace{\frac{50}{100}}_{\substack{\downarrow \\ \text{इतना stone} \\ \text{किया है}}} = \underbrace{100 \times 10 \times h}_{\text{tank area}}$$

$h = 10m$ Ans.

74

$$\frac{\sqrt{2}}{\sqrt{3}} \times 2A = P$$

\therefore Height of tetrahedron = $\frac{\sqrt{2}}{\sqrt{3}} a$

$$\frac{2}{3} \times 4 \times A^2 = P^2$$

$8A^2 = 3P^2$ Ans.



GoCareer.i

75

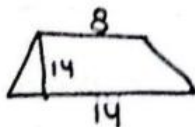

$$\frac{1}{2} \times (8+14) \times 14 \times h = 1056$$

Base Area $\times h = \text{Vol.}$

$$\Rightarrow \frac{1}{2} \times 22 \times 14 \times h = 1056 \quad 48$$

$h = \frac{48}{7}$ Ans.

76

Vol. of swimming pool = $\frac{1}{2} [\text{sum of depth of both end}] \times \text{length} \times \text{Breadth}$

83

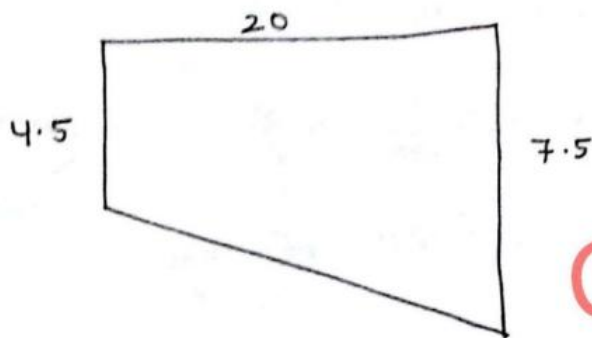

Trapezium like

GoCareer.in

$$\begin{aligned} \text{Vol.} &= \frac{1}{2} (4.5 + 7.5) \times 20 \times 10 \\ &= \frac{1}{2} \times 12 \times 20 \times 10 = 1200 \text{ m}^3. \end{aligned}$$

76

$$v = \frac{1}{3} \pi r^2 h, \quad c = \pi r l, \quad l^2 = r^2 + h^2$$

$$3\pi v h^3 - c^2 h^2 + 9v^2$$

$$\Rightarrow 3\pi \times \frac{1}{3} \pi r^2 h \times h^3 - \pi^2 r^2 (r^2 + h^2) h^2 + 9 \times \frac{1}{9} \pi^2 r^4 h^2$$

$$\Rightarrow \pi^2 r^2 h^4 - \pi^2 r^4 h^2 - \pi^2 r^2 h^4 + \pi^2 r^4 h^2 = 0 \quad \underline{\text{Ans.}}$$

77

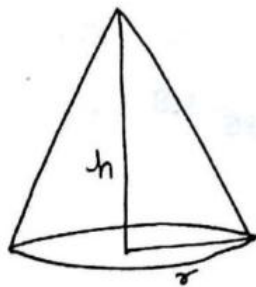

$$\pi r^2 = 4 \times 11 \quad (\text{Area})$$

$$\frac{1}{3} \pi r^2 h = 20 \times 11 \quad (\text{Vol.})$$

$$\frac{1}{3} (4 \times 11) h = \frac{5}{3} \times 11$$

$$\boxed{h = 15} \quad \underline{\text{Ans.}}$$

78

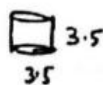
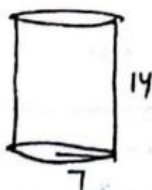

$$\pi (7^2) \times 14 = n \times \pi (3.5)^2 \times 3.5$$

$$\boxed{n = 16} \quad \underline{\text{Ans.}}$$

⊕ Frustum of a cone

$$\text{Vol.} = \frac{1}{3}\pi [R^2 + r^2 + Rr] h$$

$$\text{Surface Area} = \pi(R+r)l$$

$$\text{T.S.A} = \pi[R+r]l + \pi r^2 + \pi R^2$$

$$l = \sqrt{h^2 + (R-r)^2}$$

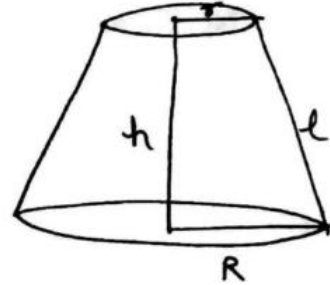

GoCareer.in

CLASS
65

TRIGONOMETRY

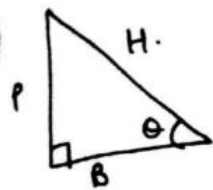

$$\sin \theta = \frac{P}{H}$$

$$\operatorname{cosec} \theta = \frac{H}{P}$$

$$\sin \theta \times \operatorname{cosec} \theta = 1$$

$$\cos \theta = \frac{B}{H}$$

$$\sec \theta = \frac{H}{B}$$

$$\cos \theta \times \sec \theta = 1$$

$\frac{P}{H}$
 $\frac{B}{H}$
 $\frac{P}{B}$
 $\frac{H}{P}$
 $\frac{H}{B}$

$$\tan \theta = \frac{P}{B}$$

$$\cot \theta = \frac{B}{P}$$

$$\tan \theta \times \cot \theta = 1$$

$$\tan \theta = \frac{\sin \theta}{\cos \theta}$$

$$\cot \theta = \frac{\cos \theta}{\sin \theta}$$



GoCareer.in

	0°	30°	45°	60°	90°
sin θ	0	$\frac{1}{2}$	$\frac{1}{\sqrt{2}}$	$\frac{\sqrt{3}}{2}$	1
cos θ	1	$\frac{\sqrt{3}}{2}$	$\frac{1}{\sqrt{2}}$	$\frac{1}{2}$	0
Tan θ	0	$\frac{1}{\sqrt{3}}$	1	$\sqrt{3}$	∞
cosec θ	∞	2	$\sqrt{2}$	$\frac{2}{\sqrt{3}}$	1
sec θ	1	$\frac{2}{\sqrt{3}}$	$\sqrt{2}$	2	∞
cot θ	∞	$\sqrt{3}$	1	$\frac{1}{\sqrt{3}}$	0

① if $\sin 17^\circ = \frac{x}{y}$. find $\sec 17^\circ - \sin 73^\circ$

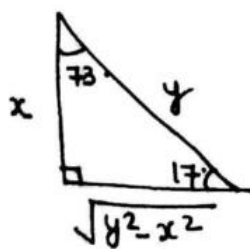

$$\sin 17^\circ = \frac{x}{y}$$

$$\sec 17^\circ - \sin 73^\circ = \frac{y}{\sqrt{y^2 - x^2}} - \frac{\sqrt{y^2 - x^2}}{y}$$

$$\Rightarrow \frac{y^2 - (y^2 - x^2)}{y\sqrt{y^2 - x^2}} \Rightarrow \frac{x^2}{y\sqrt{y^2 - x^2}} \quad \underline{\underline{\text{Ans.}}}$$

② If $\sin(10^\circ 6' 32'') = a$

$\cos(79^\circ 53' 28'') + \tan(10^\circ 6' 32'') = ?$

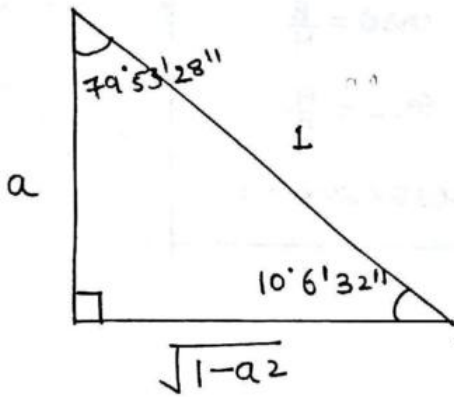

$$= \frac{a}{1} + \frac{a}{\sqrt{1-a^2}}$$

$$= \frac{a(\sqrt{1-a^2}) + a}{\sqrt{1-a^2}}$$

$\cos \theta = \frac{B}{H}$
 $\tan \theta = \frac{P}{B}$

GoCareer.in

③ In a Δxyz , $\angle Y = 90^\circ$

$XY = 2\sqrt{6}$

$\sec x + \tan x = ?$

$XZ - YZ = 2$

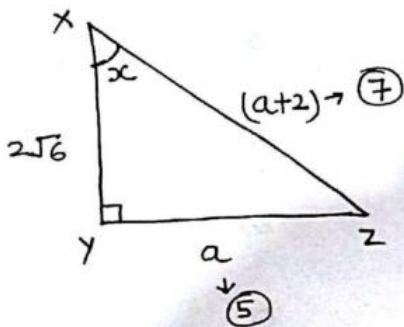

$(2\sqrt{6})^2 + a^2 = (a+2)^2$

$24 + 25 = (5+2)^2$

$a = 5$

(Put values of a to satisfy eqn)

$\sec x + \tan x = \frac{7}{2\sqrt{6}} + \frac{5}{2\sqrt{6}} = \frac{12}{2\sqrt{6}} = \frac{6}{\sqrt{6}} = \sqrt{6}$ Ans

④ In a ΔABC , $\angle B = 90^\circ$

$AB - BC = 2$, $AC = 2\sqrt{5}$

$\cos^2 A - \cos^2 C = ?$

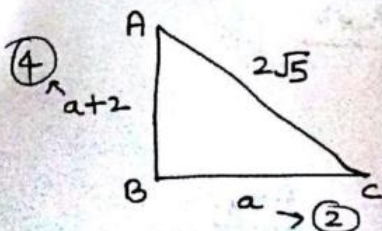

$(a+2)^2 + a^2 = (2\sqrt{5})^2$

$20 = 20$

$a = 2$

(a=2 will satisfy the relation)

#

$$\sec^2 \theta - \tan^2 \theta = 1$$

$$\sec^2 \theta = 1 + \tan^2 \theta$$

$$\tan^2 \theta = \sec^2 \theta - 1$$

$$(\sec \theta + \tan \theta)(\sec \theta - \tan \theta) = 1$$

$$(\sec \theta - \tan \theta) = \frac{1}{(\sec \theta + \tan \theta)}$$

$$(\sec \theta + \tan \theta) = \frac{1}{(\sec \theta - \tan \theta)}$$

7) $\sec \theta + \tan \theta = 3$, $\cos \theta = ?$

$$(\sec \theta - \tan \theta)(\sec \theta + \tan \theta) = 1$$

$$\therefore \downarrow \frac{1}{3}$$

$$\downarrow 3$$

$$\left(\sec \theta - \tan \theta = \frac{1}{\sec \theta + \tan \theta} \right)$$

$$\sec \theta + \tan \theta = 3$$

$$\sec \theta - \tan \theta = \frac{1}{3}$$



$$2 \sec \theta = \frac{10}{3}$$

$$\sec \theta = \frac{5}{3}$$

$$\therefore \boxed{\cos \theta = \frac{3}{5}} \quad \underline{\text{Ans}}$$

#

$$\operatorname{cosec}^2 \theta - \cot^2 \theta = 1$$

$$\operatorname{cosec}^2 \theta = 1 + \cot^2 \theta$$

$$\cot^2 \theta = \operatorname{cosec}^2 \theta - 1$$

$$(\operatorname{cosec} \theta - \cot \theta)(\operatorname{cosec} \theta + \cot \theta) = 1$$

$$\downarrow \quad \downarrow$$

$$x \quad \times \quad \frac{1}{x} = 1$$

8) $\operatorname{cosec} \theta + \cot \theta = 2 + \sqrt{5}$, $\sin \theta = ?$

$$\operatorname{cosec} \theta + \cot \theta = 2 + \sqrt{5}$$

$$\operatorname{cosec} \theta - \cot \theta = 2 - \sqrt{5}$$

$$2 \operatorname{cosec} \theta = 2\sqrt{5}$$

$$\operatorname{cosec} \theta = \sqrt{5}$$

$$\therefore \boxed{\sin \theta = \frac{1}{\sqrt{5}}} \quad \underline{\text{Ans}}$$

GoCareer.in

##

$$\begin{aligned} \sin^2 \theta + \cos^2 \theta &= 1 \\ \sin^2 \theta &= 1 - \cos^2 \theta \\ \cos^2 \theta &= 1 - \sin^2 \theta \end{aligned}$$

9) if $\sin \theta + \sin^2 \theta = 1$

$$\cos^{12} \theta + 3\cos^{10} \theta + 3\cos^8 \theta + \cos^6 \theta + 64 = ?$$

$$a^3 + 3a^2b + 3ab^2 + b^3 + 64$$

$$(\cos^4 \theta + \cos^2 \theta)^3 + 64$$

$$\begin{cases} a = \cos^4 \theta \\ b = \cos^2 \theta \end{cases}$$

⊛ अगर दो जगह 3 हो तो Try to make cube of (a+b) or (a-b)

$$\Rightarrow \sin \theta + \sin^2 \theta = 1$$

$$\sin \theta = 1 - \sin^2 \theta$$

$$\sin \theta = \cos^2 \theta$$

$$\sin^2 \theta = \cos^4 \theta$$

$$\therefore (\sin^2 \theta + \cos^2 \theta)^3 + 64 = 65 \text{ Ans}$$

GoCareer.in

10) if $\sin \theta + \sin^2 \theta + \sin^3 \theta = 1$, $\cos^6 \theta - 4\cos^4 \theta + 8\cos^2 \theta = ?$

$$\sin \theta + \sin^3 \theta = 1 - \sin^2 \theta$$

$$\sin \theta (1 + \sin^2 \theta) = \cos^2 \theta$$

$$\sin \theta (1 + 1 - \cos^2 \theta) = \cos^2 \theta$$

$$\sin \theta (2 - \cos^2 \theta) = \cos^2 \theta$$

squaring. (for making sine into cos)

$$\Rightarrow \sin^2 \theta (2 - \cos^2 \theta)^2 = \cos^4 \theta$$

$$\Rightarrow (1 - \cos^2 \theta) [4 + \cos^4 \theta - 4\cos^2 \theta] = \cos^4 \theta$$

$$\Rightarrow 4 + \cos^4 \theta - 4\cos^2 \theta - 4\cos^2 \theta - \cos^6 \theta + 4\cos^4 \theta = \cos^4 \theta$$

$$\Rightarrow -\cos^6 \theta + 4\cos^4 \theta - 8\cos^2 \theta = -4$$

$$\cos^6 \theta - 4 \cos^4 \theta + 8 \cos^2 \theta = 4 \quad \underline{\text{Ans}}$$

11) If $\cos \theta + \cos^2 \theta = 1$, $\sin^8 \theta + a \sin^6 \theta + \sin^4 \theta$

$$\begin{array}{l} \cos \theta = 1 - \cos^2 \theta \\ \cos \theta = \sin^2 \theta \\ \cos^2 \theta = \sin^4 \theta \end{array} \quad \left| \begin{array}{l} \downarrow a^2 \\ \downarrow 2ab \\ \downarrow b^2 \end{array} \right. \begin{array}{l} (\sin^4 \theta + \sin^2 \theta)^2 \\ (\cos^2 \theta + \sin^2 \theta)^2 = 1 \quad \underline{\text{Ans}} \end{array}$$

12) If $\cos \theta (1 + \sin \alpha) (1 + \sin \beta) = (1 - \sin \theta) (1 - \sin \alpha) (1 - \sin \beta) = x$

- A) $\pm \cos \theta \cdot \cos \alpha \cdot \cos \beta$
- B) $\pm \cos^2 \theta \cdot \cos^2 \alpha \cdot \cos^2 \beta$
- C) $\pm \sec \theta \cdot \sec \alpha \cdot \sec \beta$
- D) $\pm \sin \theta \cdot \sin \alpha \cdot \sin \beta$

GoCareer.in

$$(1 + \sin \theta) (1 + \sin \alpha) (1 + \sin \beta) = (1 - \sin \theta) (1 - \sin \alpha) (1 - \sin \beta) = x$$

$$\Rightarrow \begin{array}{l} x = (1 + \sin \theta) (1 + \sin \alpha) (1 + \sin \beta) \\ x = (1 - \sin \theta) (1 - \sin \alpha) (1 - \sin \beta) \end{array} \quad \left| \begin{array}{l} \therefore (1 + \sin \theta) (1 - \sin \theta) \\ = 1^2 - \sin^2 \theta \\ = \cos^2 \theta \end{array} \right.$$

$$x^2 = \cos^2 \theta \cdot \cos^2 \alpha \cdot \cos^2 \beta$$

$$x = \pm \cos \theta \cos \alpha \cos \beta. \quad \underline{\text{Ans}}$$

⊕ if $ax + by = m$
 $bx - ay = n$ (same coeff.)
 Then $(a^2 + b^2)(x^2 + y^2) = m^2 + n^2$

⊕ $a \sin \theta + b \cos \theta = m$
 $b \sin \theta - a \cos \theta = \sqrt{a^2 + b^2 - m^2}$ (same coeff.)

$$(13) \quad \frac{x}{a} \sin \theta + \frac{y}{b} \cos \theta = \frac{1}{2}$$

$$\frac{y}{b} \sin \theta - \frac{x}{a} \cos \theta = ?$$

$$\frac{y}{b} \sin \theta - \frac{x}{a} \cos \theta = \sqrt{\frac{x^2}{a^2} + \frac{y^2}{b^2} - \frac{1}{4}} \quad \underline{\underline{\text{Ans.}}}$$

$$(14) \quad 1 \sin \theta + 1 \cos \theta = \frac{2}{3}$$

$$1 \sin \theta - 1 \cos \theta = ?$$

$$\sin \theta - \cos \theta = \sqrt{1^2 + 1^2 - \left(\frac{2}{3}\right)^2}$$

$$= \sqrt{2 - \frac{4}{9}} = \sqrt{\frac{14}{9}} = \frac{\sqrt{14}}{3} \quad \underline{\underline{\text{Ans.}}}$$

$$(15) \quad 1 \sin \theta + 1 \cos \theta = \frac{17}{13}$$

$$1 \sin \theta - 1 \cos \theta = ?$$

$$\sin \theta - \cos \theta = \sqrt{1^2 + 1^2 - \left(\frac{17}{13}\right)^2}$$

$$= \sqrt{2 - \frac{289}{169}} = \sqrt{\frac{338 - 289}{169}}$$

$$= \sqrt{\frac{49}{169}} = \frac{7}{13} \quad \underline{\underline{\text{Ans.}}}$$

$$(16) \quad 3 \sin \theta + 4 \cos \theta = 5, \quad \text{Tan } \theta = ?$$

$$4 \sin \theta - 3 \cos \theta = \sqrt{3^2 + 4^2 - 5^2} = 0$$

$$4 \sin \theta - 3 \cos \theta = 0$$

$$4 \sin \theta = 3 \cos \theta$$

$$\frac{\sin \theta}{\cos \theta} = \frac{3}{4}$$

$$\text{Tan } \theta = \frac{3}{4}$$

GoCareer.in

QF) $3 \sin \theta + 4 \cos \theta = 5$ (3, 4, 5)
 \downarrow \downarrow
 P B
 अगर Triplet बन रहा हो तो sin के साथ वाला Perpendicular होता है और cos के साथ वाला Base होता है ।

$\therefore \tan \theta = \frac{P}{B} = \frac{3}{4}$ Ans.

GoCareer.in

CLASS
66

17) $(a^2 - b^2) \sin \theta + 2ab \cos \theta = a^2 + b^2$, $\tan \theta = ?$
 \downarrow \downarrow
 P B
 Triplet बन रहा है ।

$\tan \theta = \frac{P}{B} = \frac{a^2 - b^2}{2ab}$ Ans.

18) $x \sin \theta - y \cos \theta = \sqrt{x^2 + y^2}$

$\frac{\cos^2 \theta}{a^2} + \frac{\sin^2 \theta}{b^2} = \frac{1}{x^2 + y^2}$

Then which option is right.

$x \sin \theta - y \cos \theta = \sqrt{x^2 + y^2}$

A) $\frac{x^2}{b^2} + \frac{y^2}{a^2} = 1$

B) $\frac{x^2}{a^2} + \frac{y^2}{b^2} = 1$

C) $\frac{x^2}{b^2} - \frac{y^2}{a^2} = 1$

D) $\frac{x^2}{a^2} - \frac{y^2}{b^2} = 1$

$\frac{x}{\sqrt{x^2 + y^2}} \sin \theta + \frac{(-y)}{\sqrt{x^2 + y^2}} \cos \theta = 1$
 \downarrow \downarrow
 $\sin \theta$ $\cos \theta$

$\Rightarrow \frac{\cos^2 \theta}{a^2} + \frac{\sin^2 \theta}{b^2} = \frac{1}{x^2 + y^2}$

$\frac{y^2}{(x^2 + y^2)a^2} + \frac{x^2}{(x^2 + y^2)b^2} = \frac{1}{x^2 + y^2}$

$\Rightarrow \frac{1}{x^2 + y^2} \left(\frac{y^2}{a^2} + \frac{x^2}{b^2} \right) = \frac{1}{x^2 + y^2}$

(*) $\sin^2 \theta + \cos^2 \theta = 1$

$(\sin \theta) \sin \theta + (\cos \theta) \cos \theta = 1$
 \downarrow \downarrow

$\frac{x}{\sqrt{x^2 + y^2}}$ $\frac{-y}{\sqrt{x^2 + y^2}}$

$$\therefore \frac{y^2}{a^2} + \frac{x^2}{b^2} = 1 \quad \underline{\text{Ans.}}$$

$$\begin{aligned} \textcircled{18} \quad 3\sin\theta + 4\cos\theta &= 5 \\ \left(\frac{3}{5}\right)\sin\theta + \left(\frac{4}{5}\right)\cos\theta &= 1 \\ \downarrow \qquad \qquad \downarrow \\ \sin\theta \qquad \qquad \cos\theta \\ \sin^2\theta + \cos^2\theta &= 1 \\ \therefore \sin\theta &= \frac{3}{5}, \quad \cos\theta = \frac{4}{5} \end{aligned}$$

GoCareer.in

$$\textcircled{19} \quad 10\sin^4\theta + 15\cos^4\theta = 6$$

find $27\operatorname{cosec}^6\theta + 8\sec^6\theta$

$$\Rightarrow \frac{10}{6}\sin^4\theta + \frac{15}{6}\cos^4\theta = 1$$

$$\left(\frac{5}{3}\right)\sin^4\theta + \left(\frac{5}{2}\right)\cos^4\theta = 1$$

$$\downarrow \qquad \qquad \downarrow \qquad \qquad (\because \sin^2\theta + \cos^2\theta = 1)$$
$$\frac{1}{\sin^2\theta} \qquad \qquad \frac{1}{\cos^2\theta}$$

$$\frac{1}{\sin^2\theta} = \operatorname{cosec}^2\theta = \frac{5}{3}$$

$$\frac{1}{\cos^2\theta} = \sec^2\theta = \frac{5}{2}$$

$$\Rightarrow 27(\operatorname{cosec}^2\theta)^3 + 8(\sec^2\theta)^3$$

$$= 27\left(\frac{5}{3}\right)^3 + 8\left(\frac{5}{2}\right)^3$$

$$= \cancel{27} \times \frac{125}{\cancel{27}} + \cancel{8} \times \frac{125}{\cancel{8}}$$

$$= 250 \quad \underline{\underline{\text{Ans.}}}$$



OR

$$10 \frac{\sin^4 \theta}{\cos^4 \theta} + 15 \frac{\cos^4 \theta}{\cos^4 \theta} = \frac{6}{\cos^4 \theta}$$

$$\begin{aligned} 10 \tan^4 \theta + 15 &= 6 \sec^4 \theta \\ &= 6 (\sec^2 \theta)^2 \\ &= 6 (1 + \tan^2 \theta)^2 \\ 10 \tan^4 \theta + 15 &= 6 (1 + \tan^4 \theta + 2 \tan^2 \theta) \end{aligned}$$

$$\Rightarrow 4 \tan^4 \theta - 12 \tan^2 \theta + 9 = 0$$

$$(2 \tan^2 \theta - 3)^2 = 0$$

$$\therefore 2 \tan^2 \theta - 3 = 0$$

$$\tan^2 \theta = \frac{3}{2}$$

$$\Rightarrow \cot^2 \theta = \frac{2}{3}$$

$$\begin{aligned} &27 (\operatorname{cosec}^2 \theta)^3 + 8 (\sec^2 \theta)^3 \\ &= 27 (1 + \cot^2 \theta)^3 + 8 (1 + \tan^2 \theta)^3 \\ &= 27 \left(1 + \frac{2}{3}\right)^3 + 8 \left(1 + \frac{3}{2}\right)^3 \\ &= 27 \times \frac{125}{27} + 8 \times \frac{125}{8} \end{aligned}$$

$$125 + 125 = 250 \quad \underline{\text{Ans.}}$$



#

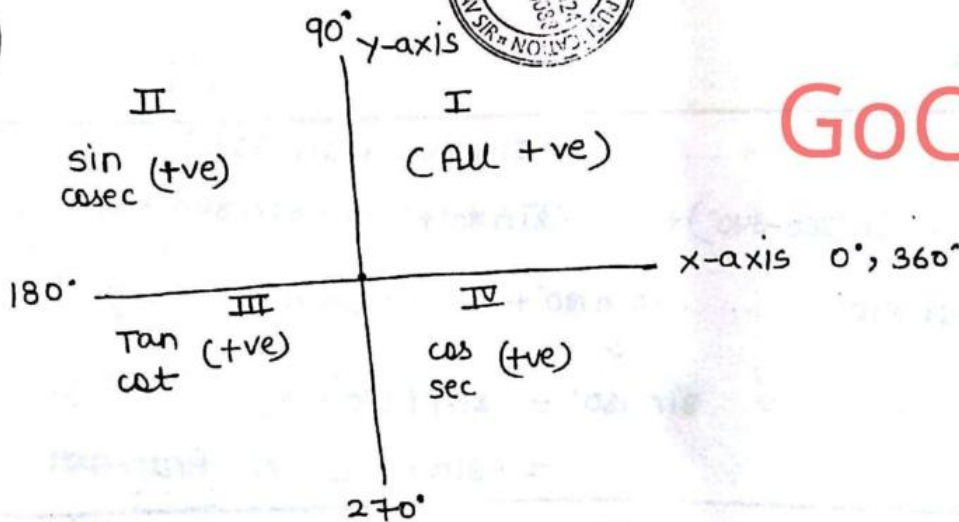

GoCareer.in

20) θ does not lie in 1st quadrant.

$$5 \sin 2\theta + 3 \sin \theta + 4 \cos \theta = ?$$

$$5 \times 2 \sin \theta \cos \theta + 3 \sin \theta + 4 \cos \theta$$

$$= 2 \left(-\frac{4}{5}\right) \left(-\frac{3}{5}\right) + 3 \left(-\frac{4}{5}\right) + 4 \left(-\frac{3}{5}\right)$$

$$\frac{24}{5} - \frac{12}{5} - \frac{12}{5} = 0 \quad \underline{\text{Ans}}$$

$$3 \tan \theta - 4 = 0$$

$$\tan \theta = \frac{4}{3} \quad \left(\begin{array}{l} \text{H} = 4 \\ \text{B} = 3 \end{array} \right) \quad (\because \theta \text{ is in 3rd quad})$$

\Rightarrow (sin, cos are (-ve) in 3rd quad., so (-ve) value is taken)

(x-axis $\pm \theta$) \rightarrow No change

$$\sin(360 + \theta) = +\sin\theta$$

$$\cos(180 - \theta) = -\cos\theta$$

$$\tan(180 + \theta) = +\tan\theta$$

\Rightarrow sign (+ or -) will be determined acc. to the quadrant.

21) A, B, C, D are the vertex of a cyclic quadrilateral. find $\cos A + \cos B + \cos C + \cos D$ -

$$\begin{array}{l|l} A+C = 180^\circ & B+D = 180^\circ \\ c = 180^\circ - A & D = 180^\circ - B \end{array}$$

$$\cos A + \cos B + \cos(180-A) + \cos(180-B)$$

$$\cos A + \cos B - \cos A - \cos B$$

$$= 0 \quad \underline{\text{Ans.}}$$

($180-A = 2^{\text{nd}}$ quad. 2^{nd} quad. में \cos (-ve) होता है)

22) $\sin 10^\circ + \sin 20^\circ + \dots + \sin 340^\circ + \sin 350^\circ$

$$\sin(360-350^\circ) + \sin(360-340^\circ) + \dots + \sin 180^\circ + \dots + \sin 340^\circ + \sin 350^\circ$$

$$- \sin 350^\circ - \sin 340^\circ \dots + \sin 180^\circ + \dots + \sin 340^\circ + \sin 350^\circ$$

$$\downarrow$$

$$\sin 180^\circ = \sin(180 + 0)$$

$$= -\sin 0 = 0 \quad \underline{\text{Ans.}}$$

(y-axis $\pm \theta$)
changes like

$$\sin\theta \rightleftharpoons \cos\theta$$

$$\tan\theta \rightleftharpoons \cot\theta$$

$$\operatorname{cosec}\theta \rightleftharpoons \sec\theta$$

$$\tan(270 + \theta) = -\cot\theta$$

$$\sin(270 + \theta) = -\cos\theta$$

$$\sec(90 + \theta) = -\operatorname{cosec}\theta$$

\downarrow
Quad. में इसको check करना है।

(23) if $A+B = 90^\circ$
 $\sin^2 A + \sin^2 B = ?$
 $A+B = 90^\circ \Rightarrow B = 90-A$
 $\sin^2 A + \sin^2(90-A)$
 $\sin^2 A + \cos^2 A$
 $= 1$ Ans.

if $A+B = 90^\circ$
 $\sin^2 A + \sin^2 B = 1$
 $\cos^2 A + \cos^2 B = 1$

(24) if $A+B = 90^\circ$
 $\sin A \cdot \sec B = ?$
 $A+B = 90^\circ$
 $B = 90-A$
 $\sin A \cdot \sec(90-A)$
 $\sin A \cdot \operatorname{cosec} A$
 $\cancel{\sin A} \cdot \frac{1}{\cancel{\sin A}}$
 $= 1$ Ans.

if $A+B = 90^\circ$
 $\sin A \cdot \sec B = 1$
 $\cos A \cdot \operatorname{cosec} B = 1$

if $A+B = 90^\circ$
 $\tan A \cdot \tan B = 1$
 $\cot A \cdot \cot B = 1$

(25) if $A+B = 90^\circ$
 $\tan A \cdot \tan B = ?$
 $\tan A \cdot \tan(90-A)$
 $\tan A \cdot \cot A$
 $\cancel{\tan A} \cdot \frac{1}{\cancel{\tan A}} = 1$

if $A+B = 90^\circ$
 $\sin A = \cos B$
 $\tan A = \cot B$
 $\operatorname{cosec} A = \sec B$

(26) $\sin(3x-6) = \cos(6x-3), \therefore$
 $x = ?$
 $\sin A = \cos B, \therefore A+B = 90^\circ$
 $\therefore 3x-6 + 6x-3 = 90^\circ$
 $9x = 99$
 $x = 11$ Ans.

GoCareer.in

(27) $\operatorname{cosec} 51^\circ = x$

$$\frac{1}{\operatorname{cosec}^2 51^\circ} + \sin^2 39^\circ + \tan^2 39^\circ - \frac{1}{\sin 51^\circ \sec 39^\circ}$$

$$\frac{\sin^2 51^\circ + \sin^2 39^\circ}{1} \quad \downarrow \quad 1 \quad (\because 51 + 39 = 90^\circ)$$

$\Rightarrow 1 + \tan^2 39^\circ - 1$

$\Rightarrow \tan^2 39^\circ$

$\tan^2 39^\circ = \sec^2 39^\circ - 1$

$= \sec^2 39^\circ - 1$

$= \boxed{x^2 - 1}$ Ans.

$\operatorname{cosec} 51^\circ = x$
 $\operatorname{cosec} (90 - 39) = x$
 $\sec 39^\circ = x$



GoCareer.in

(28) $\cot 18^\circ \left[\cos^2 68^\circ \cdot \cot 72^\circ + \frac{1}{\sec^2 22^\circ} \cdot \tan 72^\circ \right]$

$\Rightarrow \cot 18^\circ \left[\cos^2 68^\circ \cdot \cot 72^\circ + \cos^2 22^\circ \cdot \cot 72^\circ \right]$

$\Rightarrow \cot 18^\circ \cdot \cot 72^\circ \left[\cos^2 68^\circ + \cos^2 22^\circ \right]$

$\downarrow \qquad \qquad \qquad \downarrow$
 $(\because 18 + 72 = 90) \qquad (\because 68 + 22 = 90)$

$\Rightarrow 1 \times 1 = 1$ Ans.

(29) $\sin^2 1^\circ + \sin^2 5^\circ + \dots + \sin^2 90^\circ$

$\sin^2 1^\circ + \sin^2 5^\circ + \sin^2 9^\circ + \dots + \sin^2 89^\circ + \sin^2 90^\circ$

no. of terms = $\frac{\text{last term} - \text{first term}}{d} + 1$
 $= \frac{89 - 1}{4} + 1 = 23$

sum of series = yoursmahboob.wordpress.com

$$\therefore 11\frac{1}{2} + \sin^2 90^\circ$$

$$= 11\frac{1}{2} + 1 = \frac{25}{2} \text{ Ans.}$$

$$\textcircled{30} \sin^2 10^\circ + \sin^2 20^\circ + \dots + \sin^2 90^\circ$$

$$\sin^2 10^\circ + \sin^2 80^\circ = 1 \quad (\because \sin^2 A + \sin^2 B = 1$$

$$\sin^2 20^\circ + \sin^2 70^\circ = 1 \quad \text{if } A+B=90^\circ)$$

$$\sin^2 30^\circ + \sin^2 60^\circ = 1$$

$$\sin^2 40^\circ + \sin^2 50^\circ = 1$$

$$\sin^2 90^\circ = 1$$

$$\underline{\underline{5 \text{ Ans.}}}$$



$$\text{No. of terms} = \frac{80-10}{10} + 1 = 8$$

$$\text{Sum of } \sin^2 \text{ terms} = \frac{8}{2} = 4$$

$$\text{Total sum} = 4 + \sin^2 90^\circ = 4 + 1 = 5$$

OR

$$\sin^2 10^\circ + \sin^2 20^\circ + \dots + \sin^2 80^\circ + \sin^2 90^\circ$$

हम वहाँ तक series देखते हैं जहाँ तक $\theta_1 + \theta_2$ का pair बन रहा हो 90° का.

$$\text{No. of terms} = \frac{\text{Last term} - \text{first term}}{\text{diff}} + 1$$

$$= \frac{80-10}{10} + 1 = 8$$

$$\text{और इस series का sum} = \frac{\text{no. of terms}}{2} = \frac{8}{2} = 4$$

उपर $\sin^2 90^\circ$ series से अलग बचा हुआ है।

$$\therefore \sin^2 90^\circ = 1$$

$$\text{So, the sum of above ques is} = 4 + 1 = 5 \text{ Ans.}$$

CLASS
67

(31) $\cos^2 1 + \cos^2 3 + \dots + \cos^2 90.$

$\cos^2 1 + \cos^2 3 + \cos^2 5 + \dots + \cos^2 89 + \cos^2 90.$

$n = \frac{89-1}{2} + 1 = 45$

sum = $\frac{45}{2}$

$\therefore \frac{45}{2} + \underbrace{\cos^2 90}_{0} = \frac{45}{2} \text{ Ans.}$

2 से divide इसलिए करते हैं क्योंकि दो pairs का sum 1 आयेगा
($\cos^2 1 + \cos^2 89 = 1$
 $\therefore (89+1=90)$)

(32) $\sin^2 \frac{\pi}{40} + \sin^2 \frac{2\pi}{40} + \sin^2 \frac{3\pi}{40} + \dots + \sin^2 \frac{20\pi}{40}$

$\sin^2 \frac{\pi}{40} + \sin^2 \frac{2\pi}{40} + \dots + \sin^2 \frac{19\pi}{40} + \sin^2 \frac{20\pi}{40}$

$n = 19$

sum = $\frac{19}{2}$

$\therefore \frac{19}{2} + \sin^2 \frac{20\pi}{40}$

$= \frac{19}{2} + \sin^2 90 \Rightarrow \frac{19}{2} + 1 = \frac{21}{2} \text{ Ans}$

* $\frac{\frac{\pi}{40} + \frac{19\pi}{40}}{\frac{\pi+19\pi}{40}} = \frac{20\pi}{40}$
 $= \frac{\pi}{2}$ (pair बन रहा है 90 का)

(33) A, B and C are the vertex of a triangle. find

$\cos^2 \frac{A}{2} + \cos^2 \frac{B}{2} + \cos^2 \frac{C}{2} + \cos^2 \left(\frac{A+B}{2}\right) + \cos^2 \left(\frac{B+C}{2}\right) + \cos^2 \left(\frac{C+A}{2}\right)$

$\cos^2 \left(\frac{A}{2}\right) + \cos^2 \left(\frac{B+C}{2}\right)$
Pair बन रहा है

$\frac{A}{2} + \frac{B+C}{2}$

$\frac{A+B+C}{2} = \frac{180}{2} = 90$

$\cos^2 A + \cos^2 B = 1.$

(if $A+B=90$)

$$\therefore \cos^2 \frac{A}{2} + \cos^2 \frac{B+C}{2} = 1$$

There are 3 such pairs

$$\therefore 1+1+1 = 3 \text{ Ans.}$$

$\cos(-\theta) = +\cos\theta$
$\sec(-\theta) = +\sec\theta$
$\sin(-\theta) = -\sin\theta$
$\operatorname{cosec}(-\theta) = -\operatorname{cosec}\theta$
$\tan(-\theta) = -\tan\theta$
$\cot(-\theta) = -\cot\theta$

$$(34) \frac{\cos(90+A) \cdot \sec(360-A) \cdot \tan(180-A)}{\sec(A-720) \cdot \sin(A+540) \cdot \cot(A-90)}$$

$$\Rightarrow \frac{(-)\cancel{\sin A} \cdot \cancel{\sec A} \cdot (-)\cancel{\tan A}}{\cancel{\sec A} \cdot (-)\cancel{\sin A} \cdot (-)\cancel{\tan A}}$$

$\therefore \sin(540+A) \rightarrow 3^{\text{rd}}$ quadrant

$$\therefore \sin = (-ve)$$

$\Rightarrow \perp$ Ans.

$$\begin{aligned} (*) \sec(A-720) &= \sec(-(720-A)) \\ &= \sec(720-A) \\ &= \sec A \end{aligned}$$

$$\begin{aligned} (*) \cot(A-90) &= \cot[-(90-A)] \\ &= -\cot(90-A) \\ &= -\tan A \end{aligned}$$

$$(35) x = y \cos \frac{2\pi}{3} = z \cos \frac{4\pi}{3}$$

$$xy + yz + zx = ?$$

$$x = y \cos \frac{2\pi}{3} = z \cos \frac{4\pi}{3}$$

$$\Rightarrow \cos \frac{2\pi}{3} = \cos 120 = \cos(180-60) = -\cos 60 = -\frac{1}{2}$$

$$\Rightarrow \cos \frac{4\pi}{3} = \cos 240 = \cos(180+60) = -\cos 60 = -\frac{1}{2}$$

$$x = -\frac{y}{2} = -\frac{z}{2} = K$$

$$x = K \quad | \quad y = -2K \quad | \quad z = -2K$$

$$xy + yz + zx = K(-2K) + (-2K)(-2K) + (-2K)K$$

$$= -2K^2 + 4K^2 - 2K^2 = 0 \text{ Ans.}$$

(35) put values.

$$x = 1 \quad \left| \begin{array}{l} -\frac{y}{2} \\ y = -2 \end{array} \right| \quad \begin{array}{l} -\frac{z}{2} \\ z = -2 \end{array}$$

$$xy + yz + zx = -2 \times 1 + (-2)(-2) + (-2) \times 1$$

$$-2 + 4 - 2 = 0 \quad \underline{\text{Ans}}$$

(36) $\sin(A+B-C) = \cos(A+C-B) = \tan(B+C-A) = 1$

$$A+B+C = ?$$

$$\begin{array}{l} \sin(A+B-C) = 1 \\ \sin 90^\circ = 1 \\ \therefore A+B-C = 90^\circ \end{array} \quad \left| \begin{array}{l} \cos(A+C-B) = 1 \\ \cos 0 = 1 \\ \therefore A+C-B = 0 \end{array} \right| \quad \left| \begin{array}{l} \tan(B+C-A) = 1 \\ \tan 45 = 1 \\ \therefore B+C-A = 45 \end{array} \right.$$

$$A+B-C = 90$$

$$A+C-B = 0$$

$$\hline 2A = 90$$

$$\boxed{A = 45}$$

$$B+C-A = 45$$

$$A+C-B = 0$$

$$\hline 2C = 45$$

$$\boxed{C = \frac{45}{2}}$$

$$\Rightarrow A+C-B = 0$$

$$45 + \frac{45}{2} = B$$

$$\Rightarrow \boxed{B = \frac{135}{2}}$$

$$A+B+C = 45 + \frac{45}{2} + \frac{135}{2}$$

$$= \frac{90 + 45 + 135}{2}$$

$$= \frac{270}{2} = 135 \quad \underline{\text{Ans}}$$

37) $\frac{\tan 57^\circ + \cot 37^\circ}{\tan 33^\circ + \cot 53^\circ}$

A) $\tan 33^\circ \cdot \cot 53^\circ$ B) $\tan 53^\circ \cdot \cot 37^\circ$

C) $\tan 33^\circ \cdot \cot 57^\circ$

D) $\tan 57^\circ \cdot \cot 37^\circ$

$$\frac{\tan 57^\circ + \cot 37^\circ}{\tan(90-57^\circ) + \cot 53^\circ}$$

$$\Rightarrow \frac{\tan 57^\circ + \frac{1}{\tan 37^\circ}}{\cot 57^\circ + \cot(90-53^\circ)}$$

$$\Rightarrow \frac{\tan 57^\circ + \frac{1}{\tan 37^\circ}}{\frac{1}{\tan 57^\circ} + \tan 37^\circ}$$

$$\Rightarrow \frac{(\tan 57^\circ \cdot \tan 37^\circ) + 1}{\tan 37^\circ}$$

$$\Rightarrow \frac{1}{\tan 37^\circ} \times \tan 57^\circ$$

$$\frac{(\tan 57^\circ \cdot \tan 37^\circ) + 1}{\tan 57^\circ}$$

$$\Rightarrow \tan 57^\circ \cdot \cot 37^\circ \quad \underline{\underline{\text{Ans.}}}$$

38) $\tan 40^\circ + 2 \tan 10^\circ = ?$
 $40+10 = 50$
 $\tan(40+10) = \tan 50^\circ$

- A) $\tan 40^\circ$ B) $\cot 40^\circ$
 C) $\sin 40^\circ$ D) $\cos 40^\circ$

$$\frac{\tan 40^\circ + \tan 10^\circ}{1 - \tan 40^\circ \tan 10^\circ} = \tan 50^\circ$$

$$\tan(A+B) = \frac{\tan A + \tan B}{1 - \tan A \cdot \tan B}$$

$$\tan 40^\circ + \tan 10^\circ = \tan 50^\circ - \underbrace{\tan 50^\circ \cdot \tan 40^\circ \cdot \tan 10^\circ}_{\downarrow}$$

\downarrow
 \perp
 $(\because \tan A \cdot \tan B = \pm 1 \text{ if } A+B=90^\circ)$

$$\Rightarrow \tan 40^\circ + \tan 10^\circ = \tan 50^\circ - \tan 10^\circ$$

$$\begin{aligned} \Rightarrow \tan 40^\circ + 2 \tan 10^\circ &= \tan 50^\circ \\ &= \tan(90-40) \\ &= \cot 40^\circ \quad \underline{\underline{\text{Ans}}} \end{aligned}$$

#

$$\tan(A-B) = \frac{\tan A - \tan B}{1 + \tan A \cdot \tan B}$$

$$\tan(45+\theta) = \frac{1 + \tan \theta}{1 - \tan \theta} = \frac{\cos \theta + \sin \theta}{\cos \theta - \sin \theta}$$

$$\tan(45-\theta) = \frac{1 - \tan \theta}{1 + \tan \theta} = \frac{\cos \theta - \sin \theta}{\cos \theta + \sin \theta}$$

$$\tan(A+B) = \frac{\tan A + \tan B}{1 - \tan A \cdot \tan B}$$

(39) $\frac{\cos 15 - \sin 15}{\cos 15 + \sin 15}$

GoCareer.in

$\Rightarrow \tan(45-15)$

$\Rightarrow \tan 30 = \frac{1}{\sqrt{3}}$ Ans.

#

$$\sin \theta \cdot \sin(60-\theta) \cdot \sin(60+\theta) = \frac{1}{4} \sin 3\theta$$

$$\cos \theta \cdot \cos(60-\theta) \cdot \cos(60+\theta) = \frac{1}{4} \cos 3\theta$$

$$\tan \theta \cdot \tan(60-\theta) \cdot \tan(60+\theta) = \tan 3\theta$$

(40) $\sin(\widehat{20}) \sin(\widehat{40}) \sin(\widehat{80}) = ?$

$\downarrow \quad \quad \downarrow \quad \quad \downarrow$
 $\theta \quad \quad 60-\theta \quad \quad 60+\theta$

$\Rightarrow \frac{1}{4} \sin 3\theta = \frac{1}{4} \sin 60$

$= \frac{1}{4} \times \frac{\sqrt{3}}{2} = \frac{\sqrt{3}}{8}$ Ans.

$$\textcircled{41} \quad \cos(12) \cos(24) \cos(36) \cos(48) \cos 60 \cos(72) \cos(84) = ?$$

$\theta \qquad \phi \qquad 60-\phi \qquad 60-\theta \qquad 60+\theta \qquad 60+\phi$

$$\frac{1}{4} \cos 3\theta * \frac{1}{4} \cos 3\phi * \cos 60$$

$$\cos 36 = \frac{\sqrt{5}+1}{4}$$

$$\cos 72 = \frac{\sqrt{5}-1}{4}$$

$$\Rightarrow \frac{1}{4} \cos(3 \times 12) \times \frac{1}{4} \cos(3 \times 24) \times \cos 60$$

$$\Rightarrow \frac{1}{4} \cos 36 \times \frac{1}{4} \cos 72 \times \cos 60$$

$$\Rightarrow \frac{1}{4} \times \frac{(\sqrt{5}+1)}{4} \times \frac{1}{4} \times \frac{(\sqrt{5}-1)}{4} \times \frac{1}{2}$$

$$\Rightarrow \frac{1}{4} \times \frac{(\sqrt{5})^2 - (1)^2}{4 \times 4} \times \frac{1}{4} \times \frac{1}{2}$$

$$\Rightarrow \frac{1}{4} \times \frac{4}{4 \times 4} * \frac{1}{4} \times \frac{1}{2} = \frac{1}{128} \quad \underline{\underline{\text{Ans}}}$$

$$\textcircled{42} \quad \sin \frac{\pi}{9} \cdot \sin \frac{5\pi}{9} \cdot \sin \frac{7\pi}{9} \cdot \sin \frac{3\pi}{9}$$

$$\sin 20 \cdot \sin 100 \cdot \sin 140 \cdot \sin 60$$

$$\sin 20 \cdot \sin(180-80) \cdot \sin(180-40) \cdot \frac{\sqrt{3}}{2}$$

$$\Rightarrow \sin 20 \cdot \sin 40 \cdot \sin 80 \cdot \frac{\sqrt{3}}{2}$$

$$\Rightarrow \frac{1}{4} \sin 60 \times \frac{\sqrt{3}}{2}$$

$$\Rightarrow \frac{1}{4} \times \frac{\sqrt{3}}{2} \times \frac{\sqrt{3}}{2}$$

$$\Rightarrow \frac{3}{16} \quad \underline{\underline{\text{Ans}}}$$

CLASS
68

(43) $\frac{\sin 2x}{\sin \frac{x}{4}}$

$\sin 2\theta = 2 \sin \theta \cos \theta$

$\Rightarrow 2 \sin x \cdot \cos x \Rightarrow 2 \sin 2\left(\frac{x}{2}\right) \cdot \cos x \Rightarrow 4 \sin \frac{x}{2} \cdot \cos \frac{x}{2} \cdot \cos x$

$\Rightarrow 4 \sin 2\left(\frac{x}{2 \times 2}\right) \cdot \cos \frac{x}{2} \cdot \cos x$

$\Rightarrow \frac{4 \times 2 \sin \frac{x}{4} \cdot \cos \frac{x}{4} \cdot \cos \frac{x}{2} \cdot \cos x}{\cancel{\sin \frac{x}{4}}}$

$\Rightarrow 8 \cos \frac{x}{4} \cdot \cos \frac{x}{2} \cdot \cos x$ Ans



(OR) मैं देखी formula कितनी बार Apply हुआ है ।

2x से x पे गए
x से $\frac{x}{2}$ पे गए
 $\frac{x}{2}$ से $\frac{x}{4}$ पे गए
3 बार apply किया है ।

एक बार $\cos \frac{x}{4}$ बचेगा
एक बार $\cos \frac{x}{2}$ बचेगा
और $\cos x$ बचेगा ।

$2 \times 2 \times 2 \times \cos \frac{x}{4} \cdot \cos \frac{x}{2} \cdot \cos x$ Ans

(44) $\frac{\sin x}{\sin \frac{x}{16}}$

$2 \times 2 \times 2 \times 2 \cdot \cos \frac{x}{2} \cdot \cos \frac{x}{4} \cdot \cos \frac{x}{8} \cdot \cos \frac{x}{16}$

$16 \cdot \cos \frac{x}{2} \cdot \cos \frac{x}{4} \cdot \cos \frac{x}{8} \cdot \cos \frac{x}{16}$ Ans.

(45) if $A+B = \frac{\pi}{4}$ yoursmahboob.wordpress.com

$$(\cot A - 1)(\cot B - 1) = ?$$

$$A+B = \frac{\pi}{4}$$

$$\cot(A+B) = \cot 45^\circ$$

GoCareer.in

$$\Rightarrow \frac{\cot A \cot B - 1}{\cot A + \cot B} = \frac{1}{1}$$

$$\Rightarrow \cot A \cot B - 1 = \cot A + \cot B$$

$$\Rightarrow \cot A \cot B - 1 - \cot A - \cot B = 0$$

$$\Rightarrow \cot A [\cot B - 1] - 1 [\cot B - 1] = 0$$

$$\Rightarrow \cot A [\cot B - 1] - 1 [\cot B - 1] = 2$$

$$\Rightarrow (\cot A - 1)(\cot B - 1) = 2 \quad \underline{\text{Ans}}$$

(46) if $A+B+C = 180^\circ$ | $\tan A + \tan B + \tan C = ?$

$$A+B = 180 - C$$

$$\tan(A+B) = \tan(180 - C)$$

$$= \frac{\tan A + \tan B}{1 - \tan A \tan B} = -\frac{\tan C}{1}$$

$$= \tan A + \tan B = -\tan C + \tan A \tan B \tan C$$

$$= \text{i) } \tan A + \tan B + \tan C = \tan A \cdot \tan B \cdot \tan C$$

$$\text{ii) } \frac{1}{\tan B \cdot \tan C} + \frac{1}{\tan A \cdot \tan C} + \frac{1}{\tan A \cdot \tan B} = 1$$

$$\text{iii) } \cot A \cot B + \cot B \cot C + \cot C \cot A = 1$$

(47) $1 + \sin x + \sin^2 x + \sin^3 x + \dots \dots \dots \infty = 4 + 2\sqrt{3} \quad | \quad x = ?$

$S_{\infty} = \frac{a}{1-r}$ (GP series)

$\Rightarrow \frac{1}{1-\sin x} = 4 + 2\sqrt{3} \times \frac{(4-2\sqrt{3})}{4-2\sqrt{3}}$

$\Rightarrow \frac{1}{1-\sin x} = \frac{4}{4-2\sqrt{3}}$

$\Rightarrow \frac{1}{1-\sin x} = \frac{\frac{4}{4}}{\frac{4}{4} - \frac{2\sqrt{3}}{4}}$ (divide by 4)

$\Rightarrow \frac{1}{1-\sin x} = \frac{1}{1 - \frac{\sqrt{3}}{2}}$

comparing both sides

$\sin x = \frac{\sqrt{3}}{2}$

$\sin x = \sin 60^\circ$

$x = 60^\circ$ Ans

* comparison करने के लिए R.H.S को L.H.S वाली form में लाते हैं।

(48) $\sin^2(40+2x) + \sin^2(50-2x) = ?$

$40+2x + 50-2x = 90^\circ$

$\sin^2 A + \sin^2 B = 1$ if $A+B = 90^\circ$

$\therefore \sin^2(40+2x) + \sin^2(50-2x) = 1$ Ans

(49) $\cos 15^\circ \cdot \cos 7\frac{1}{2} \cdot \sin 7\frac{1}{2} = ?$

$\Rightarrow \cos 15^\circ \cdot \frac{1}{2} [2 \cos 7\frac{1}{2} \cdot \sin 7\frac{1}{2}]$

$\Rightarrow \frac{1}{2} \cos 15^\circ \times \sin 15^\circ$

$\Rightarrow \frac{1}{2} \cos 15^\circ \cdot \sin 15^\circ$

$$\frac{1}{2 \times 2} \times 2 \sin 15^\circ \cdot \cos 15^\circ$$

$$\Rightarrow \frac{1}{4} \cdot \sin 30^\circ \Rightarrow \frac{1}{4} \times \frac{1}{2} \Rightarrow \frac{1}{8} \text{ Ans}$$

50) $\cos(20^\circ) \cdot \cos(40^\circ) \cdot \cos 60^\circ \cdot \cos(80^\circ) = ?$

\downarrow \downarrow \downarrow
 θ $(60-\theta)$ $(60+\theta)$

$$\Rightarrow \frac{1}{4} \cos 3 \times 20^\circ \cdot \cos 60^\circ$$

$$\Rightarrow \frac{1}{4} \times \frac{1}{2} \times \frac{1}{2} = \frac{1}{16} \text{ Ans}$$

51) $\sin 12^\circ \cdot \sin 48^\circ \cdot \sin 54^\circ = ?$

$$\sin(12^\circ) \cdot \sin(48^\circ) \cdot \sin(72^\circ) \times \frac{1}{\sin 72^\circ} \cdot \sin 54^\circ$$

\downarrow \downarrow \downarrow
 θ $(60-\theta)$ $(60+\theta)$

$$\Rightarrow \frac{1}{4} \sin 3 \times 12^\circ \times \frac{1}{\sin 72^\circ} \cdot \sin(90-36)$$

$$\Rightarrow \frac{1}{4} \sin 36^\circ \cdot \cos 36^\circ \times \frac{1}{\sin 72^\circ}$$

$$\Rightarrow \frac{1}{4 \times 2} \cdot 2 \sin 36^\circ \cdot \cos 36^\circ \times \frac{1}{\sin 72^\circ}$$

$$\Rightarrow \frac{1}{8} \cancel{\sin 72^\circ} \times \frac{1}{\cancel{\sin 72^\circ}} \Rightarrow \frac{1}{8} \text{ Ans}$$

MAXIMA & MINIMA

	min	max.
$\sin \theta, \cos \theta$ (odd power)	-1	+1
$\sin^2 \theta, \cos^2 \theta$ (even power)	0	+1

	min	max
$\tan \theta, \cot \theta$ (odd power)	$-\infty$	$+\infty$
$\tan^2 \theta, \cot^2 \theta$ (even power)	0	$+\infty$
$\sec \theta, \csc \theta$ (odd power)	$-\infty$	$+\infty$
$\sec^2 \theta, \csc^2 \theta$ (even power)	+1	$+\infty$

(52) find minimum & maximum value of $15 + \sin^2 \theta$

$$\text{min. value} = 15 + 0 = 15$$

$$\text{max. value} = 15 + 1 = 16$$

(53) find minimum & max. value of $15 - \sin^2 \theta$

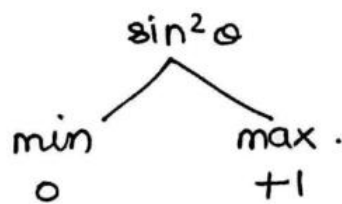

GoCareer.in

$$15 - 0 = 15$$

$$15 - 1 = 14$$

$$\therefore \text{min. value} = 14$$

$$\text{max. value} = 15$$

(54) find min & max value of $10 + \sec^2 \theta$

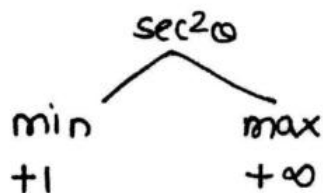

$$\text{min value} = 10 + 1 = 11$$

max. can't be determined.

55) find min & max. value of $15 \sin^2 \theta + 10 \cos^2 \theta$

$$= 15 \sin^2 \theta + 10(1 - \sin^2 \theta)$$

$$= 15 \sin^2 \theta + 10 - 10 \sin^2 \theta$$

$$= 10 + 5 \sin^2 \theta$$

$$10 + 0 = 10 \rightarrow \text{min.}$$

$$10 + 5 = 15 \rightarrow \text{max.}$$

* एक Tangent में convert करना पड़ेगा।

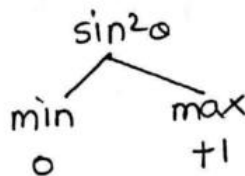

Ans:

GoCareer.in

#

$a \sin^2 \theta + b \cos^2 \theta$	
if $a > b$	if $a < b$
max = a	max = b
min = b	min = a

56) $\sin^{110} \theta \cdot \cos^{110} \theta$. find min & max. value.

$$= \frac{1}{2^{110}} \times 2^{110} \sin^{110} \theta \cdot \cos^{110} \theta$$

$$= \frac{1}{2^{110}} \left[2 \sin \theta \cos \theta \right]^{110}$$

$$= \frac{1}{2^{110}} \sin^{110} 2\theta$$

$$= \frac{1}{2^{110}} \times 1 = \frac{1}{2^{110}} \rightarrow \text{max.}$$

$$\Rightarrow \frac{1}{2^{110}} \times 0 = 0 \rightarrow \text{min}$$

$\sin^n \theta \cdot \cos^n \theta$
max. $\rightarrow \frac{1}{2^n}$
if n is even min $\rightarrow 0$
if n is odd min $\rightarrow -\frac{1}{2^n}$

(57) $\sin^5 \theta \cdot \cos^5 \theta$. find min. value

$$\text{min value} = -\frac{1}{2^n} = -\frac{1}{2^5} = -\frac{1}{32} \text{ Ans}$$

#

$$\sin^{2n} \theta + \cos^{2m} \theta \leq 1$$
$$\therefore \text{max.} = 1$$

GoCareer.in

(58) max. value of $\sin^8 \theta + \cos^4 \theta$

$$\text{max value} = 1.$$

(59) find max. value of $\sin^6 \theta + \cos^6 \theta$

$$\text{max. value} = 1.$$



#

$$\sin^4 \theta + \cos^4 \theta = 1 - 2 \sin^2 \theta \cos^2 \theta$$
$$\sin^6 \theta + \cos^6 \theta = 1 - 3 \sin^2 \theta \cos^2 \theta$$

(60) find min. and max. value of $\sin^4 \theta + \cos^4 \theta$

$$\sin^4 \theta + \cos^4 \theta = 1 - 2 \sin^2 \theta \cos^2 \theta$$

$$\Rightarrow 1 - 2(0) = 1$$

And $1 - 2\left(\frac{1}{4}\right)$
 $1 - \frac{1}{2} = \left(\frac{1}{2}\right)$

$$\begin{array}{l} \sin^2 \theta \cos^2 \theta \\ \swarrow \quad \searrow \\ \text{min} = 0 \quad \text{max} = \frac{1}{2^n} \\ \quad \quad \quad = \frac{1}{4} \end{array}$$

$$\text{min value} = \frac{1}{2}$$

$$\text{max. value} = 1$$

⊕

$$\sin^{2n} \theta + \cos^{2m} \theta$$

$$\max = +1$$

$$\min = \text{put } \theta = 45^\circ$$

Because 45° पर इसका local minima बनता है।

⊕

$$a \sin \theta + b \cos \theta$$

$$\max = +\sqrt{a^2 + b^2}$$

$$\min = -\sqrt{a^2 + b^2}$$

61) $\sin^2 \theta + \cos^4 \theta$. find max. and min. value.

$$\max = 1.$$

$$\min = \sin^2 45^\circ + \cos^4 45^\circ$$

$$= \left(\frac{1}{\sqrt{2}}\right)^2 + \left(\frac{1}{\sqrt{2}}\right)^4$$

$$= \frac{1}{2} + \frac{1}{4} = \frac{3}{4} \text{ Ans}$$

for min put
 $\theta = 45^\circ$

62) $\sin^6 \theta + \cos^6 \theta$. find max. and min. value.

$$\max = 1$$

$$\min = \left(\frac{1}{\sqrt{2}}\right)^6 + \left(\frac{1}{\sqrt{2}}\right)^6$$

$$\Rightarrow \left(\left(\frac{1}{\sqrt{2}}\right)^2\right)^3 + \left(\left(\frac{1}{\sqrt{2}}\right)^2\right)^3$$

$$\Rightarrow \left(\frac{1}{2}\right)^3 + \left(\frac{1}{2}\right)^3$$

$$\Rightarrow \frac{1}{8} + \frac{1}{8} = \frac{1}{4} \text{ Ans.}$$

for min. put
 $\theta = 45^\circ$

63) $3 \sin \theta + 4 \cos \theta$. find min. value

$$-\sqrt{3^2 + 4^2}$$

$$-5 \text{ Ans.}$$

(64) $27 \sin^3 \theta \times 81 \cos^3 \theta$. find max. and min. value.

$$\Rightarrow 3^3 \sin^3 \theta \times 3^4 \cos^3 \theta$$

$$\Rightarrow 3^7 (3 \sin \theta + 4 \cos \theta)$$

$$\therefore \text{max} = 3^5$$

$$\text{min} = 3^{-5} \quad \underline{\underline{\text{Ans.}}}$$

(*) $3 \sin \theta + 4 \cos \theta$

$$\text{max} = \sqrt{3^2 + 4^2} = 5$$

$$\text{min} = -5$$

(65) $10 \sin \theta \cdot \cos \theta + 1 - 2 \sin^2 \theta$. find max. & min value.

$$\Rightarrow 5 \times 2 \sin \theta \cos \theta + 1 - 2 \sin^2 \theta$$

$$\Rightarrow 5 \sin 2\theta + 1 \cos 2\theta$$

$$\text{max} = +\sqrt{5^2 + 1^2} = +\sqrt{26}$$

$$\text{min} = -\sqrt{26} \quad \underline{\underline{\text{Ans.}}}$$

(#)

$$\cos 2\theta = \cos^2 \theta - \sin^2 \theta$$

$$= 2 \cos^2 \theta - 1$$

$$= 1 - 2 \sin^2 \theta$$

$$= \frac{1 - \tan^2 \theta}{1 + \tan^2 \theta}$$

$$1 + \cos 2\theta = 2 \cos^2 \theta$$

(#)

$$a \tan^2 \theta + b \cot^2 \theta$$

$$\text{min} = 2\sqrt{ab}$$

$$\text{max} = \infty$$

(66) $4 \tan^2 \theta + 25 \cot^2 \theta$. find min. value.

$$\text{min value} = 2\sqrt{4 \times 25}$$

$$= 2\sqrt{100}$$

$$= 20 \quad \underline{\underline{\text{Ans.}}}$$

67) $4 \sec^2 \theta + 25 \operatorname{cosec}^2 \theta$. find min. value.

$$\Rightarrow 4(1 + \tan^2 \theta) + 25(1 + \cot^2 \theta)$$

$$\Rightarrow 4 + 4 \tan^2 \theta + 25 + 25 \cot^2 \theta$$

$$\Rightarrow 29 + \underbrace{4 \tan^2 \theta + 25 \cot^2 \theta}$$

↓
min value = 20 (in last que.)

$$\Rightarrow 29 + 20 = 49 \quad \underline{\underline{\text{Ans.}}}$$

$a \sin^2 \theta + b \operatorname{cosec}^2 \theta$
if $a < b$
min = $a + b$
if $a > b$
min = $2\sqrt{ab}$

$a \cos^2 \theta + b \sec^2 \theta$
if $a < b$
min = $a + b$
if $a > b$
min = $2\sqrt{ab}$

68) $4 \sin^2 \theta + 25 \operatorname{cosec}^2 \theta$. find min. value.

$$\text{min} = 4 + 25 = 29.$$

69) $4 \operatorname{cosec}^2 \theta + 25 \sin^2 \theta$. find min. value.

$$\text{min} = 2\sqrt{4 \times 25} = 20.$$

70) $25 \operatorname{cosec}^2 \theta + 25 \sin^2 \theta$. find min value.

$$2\sqrt{25 \times 25}$$

$$2 \times 25$$

$$= 50$$

Ans

$$25 + 25$$

$$= 50$$

Ans.

yoursmahboob.wordpress.com

(71)

$\sin^2 \theta + \operatorname{cosec}^2 \theta$. find min value.

$$\min = 1+1 = 2$$

$$\text{or } 2\sqrt{|x|} = 2$$

(72)

$\cos^2 \theta + \sec^2 \theta$. find min value.

$$\min = 1+1 = 2$$

(73)

$\tan^2 \theta + \cot^2 \theta$. find min value.

$$\min = 2\sqrt{|x|} = 2$$

(74)

$\sin^2 \theta + \operatorname{cosec}^2 \theta + \cos^2 \theta + \sec^2 \theta + \tan^2 \theta + \cot^2 \theta$. find min value.

$$1 + 1 + \cot^2 \theta + 1 + \tan^2 \theta + \tan^2 \theta + \cot^2 \theta$$

$$3 + 2 \tan^2 \theta + 2 \cot^2 \theta$$

$$3 + 2\sqrt{2x2}$$

$$3 + 4 = 7 \quad \underline{\underline{\text{Ans.}}}$$



$$\operatorname{cosec}^2 \theta = 1 + \cot^2 \theta$$

$$\sec^2 \theta = 1 + \tan^2 \theta$$

##

$$\frac{1}{\cos 2\theta} = \frac{1 + \tan^2 \theta}{1 - \tan^2 \theta}$$

$$(a+b)^2 + (a-b)^2 = 2(a^2 + b^2)$$

$$(a+b)^2 - (a-b)^2 = 4ab$$

GoCareer.in

Rakesh Yadav

⊕ value putting

i) sin, cos हो तो try to put $\theta = 0^\circ, 90^\circ, \dots$

ii) sin, cos, tan हो तो put $\theta = 45^\circ$

⊗ denominator में zero नहीं बनना चाहिए ।

75) find numerical value of

$$(1 - 2 \sin^2 \theta) \left[\frac{1 + \tan \theta}{1 - \tan \theta} + \frac{1 - \tan \theta}{1 + \tan \theta} \right]$$

$$\cos 2\theta \left[\frac{(1 + \tan^2 \theta)^2 + (1 - \tan^2 \theta)^2}{(1 - \tan \theta)(1 + \tan \theta)} \right]$$

$$\cos 2\theta \left[\frac{2(1 + \tan^2 \theta)}{1 - \tan^2 \theta} \right]$$

$$\cancel{\cos 2\theta} \times 2 \cdot \frac{1}{\cancel{\cos 2\theta}} = 2 \quad \underline{\text{Ans}}$$



⊙ OR put $\theta = 0^\circ$

$$1 \left[1 + \frac{1}{1} \right] = 2 \quad \underline{\text{Ans}}$$

76) $\sqrt{2 + \sqrt{2 + 2 \cos 4\theta}}$

A) $2 \tan \theta$ B) $2 \sin \theta$

C) $2 \cos \theta$ D) $\cos \theta$

$$= \sqrt{2 + \sqrt{2(1 + \cos 4\theta)}}$$

$$= \sqrt{2 + \sqrt{2 \times 2 \cos^2 2\theta}}$$

$$= \sqrt{2 + 2 \cos 2\theta}$$

$$= \sqrt{2(1 + \cos 2\theta)}$$

$$= \sqrt{2 \times 2 \cos^2 \theta}$$

$$= 2 \cos \theta \quad \underline{\text{Ans}}$$

⊙ OR put $\theta = 0^\circ$

$$\sqrt{2 + \sqrt{2 + 2}} = \sqrt{4} = 2$$

option c satisfies.

77) if $x = \sin\theta + \cos\theta$
 $y = \sec\theta + \operatorname{cosec}\theta$

$y = ?$

A) $\frac{2x}{x^2-1}$ B) $\frac{2x}{x^2+1}$
 C) $\frac{x}{x^2+1}$ D) $\frac{x}{x^2-1}$

$$y = \frac{1}{\cos\theta} + \frac{1}{\sin\theta}$$

$$y = \frac{\sin\theta + \cos\theta}{\cos\theta \cdot \sin\theta}$$

$$y = \frac{2(\sin\theta + \cos\theta)}{2\sin\theta \cos\theta}$$

$$y = \frac{2x}{x^2-1}$$

$$x^2 = \sin^2\theta + \cos^2\theta + 2\sin\theta \cos\theta$$

$$x^2 - 1 = 2\sin\theta \cos\theta$$

OR) put $\theta = 45^\circ$
 $x = \frac{1}{\sqrt{2}} + \frac{1}{\sqrt{2}} = \sqrt{2}$

$$y = \sqrt{2} + \sqrt{2} = 2\sqrt{2}$$

option A satisfies.

78) $(1 + \operatorname{cosec}\theta + \cot\theta)(1 - \sec\theta + \tan\theta) = ?$

$$\Rightarrow \left(1 + \frac{1}{\sin\theta} + \frac{\cos\theta}{\sin\theta}\right) \left(1 - \frac{1}{\cos\theta} + \frac{\sin\theta}{\cos\theta}\right)$$

$$\Rightarrow \left(\frac{\sin\theta + 1 + \cos\theta}{\sin\theta}\right) \left(\frac{\cos\theta - 1 + \sin\theta}{\cos\theta}\right)$$

$$\Rightarrow \frac{[(\sin\theta + \cos\theta) + 1][(\sin\theta + \cos\theta) - 1]}{\sin\theta \cdot \cos\theta}$$

$$\Rightarrow \frac{(\sin\theta + \cos\theta)^2 - (1)^2}{\sin\theta \cdot \cos\theta} \Rightarrow \frac{\cancel{1} + 2\sin\theta \cos\theta \cancel{1}}{\sin\theta \cos\theta}$$

$$\Rightarrow \frac{2\cancel{\sin\theta \cos\theta}}{\cancel{\sin\theta \cos\theta}} \Rightarrow 2 \text{ Ans.}$$

OR) put $\theta = 45^\circ$
 $(2 + \sqrt{2})(2 - \sqrt{2})$
 $4 - 2$
 $= 2 \text{ Ans.}$

79) $u_n = \cos^n\theta + \sin^n\theta$. find value of $2u_6 - 3u_4 + 1$

$$\Rightarrow 2(\cos^6\theta + \sin^6\theta) - 3(\cos^4\theta + \sin^4\theta) + 1$$

$$\Rightarrow 2[1 - 3\sin^2\theta \cos^2\theta] - 3[1 - 2\sin^2\theta \cos^2\theta] + 1$$

$$\Rightarrow 2 - 6\cancel{\sin^2\theta \cos^2\theta} - 3 + 6\cancel{2\sin^2\theta \cos^2\theta} + 1 = 0 \text{ Ans.}$$

OR put $\theta = 0$ yoursmahboob.wordpress.com

$$2(1+0) - 3(1+0) + 1 = 2 - 3 + 1 = 0 \text{ Ans.}$$

80) if $\tan^2 \theta = 1 - e^2$
 $\sec \theta + \tan^3 \theta \cdot \operatorname{cosec} \theta = ?$

- A) $(2 - e^2)^{3/2}$ B) $(2 - e^2)^{1/2}$
 C) $(1 - e^2)^{1/2}$ D) $(1 + e^2)^{5/2}$

$$\frac{1}{\cos \theta} + \frac{\sin^3 \theta}{\cos^3 \theta} \cdot \frac{1}{\sin \theta}$$

$$\frac{\cos^2 \theta + \sin^2 \theta}{\cos^3 \theta} = \frac{1}{\cos^3 \theta} = \sec^3 \theta$$

$$\Rightarrow \sec^2 \theta = 1 + \tan^2 \theta = 1 + 1 - e^2$$

$$\sec^2 \theta = 2 - e^2$$

$$\sec^3 \theta = (2 - e^2)^{3/2} \text{ Ans.}$$

OR put $\theta = 45^\circ$

$$\sqrt{2} + 1 \times \sqrt{2}$$

$$\sqrt{2} + \sqrt{2}$$

$$2 \times \sqrt{2}$$

$$2^1 2^{3/2} = 2^{3/2}$$

$$\tan^2 \theta = 1 - e^2$$

$$1 = 1 - e^2$$

$$e^2 = 0 \rightarrow \text{put in options}$$

सही square Ans. option A satisfies.

81) $x \sin^3 \theta + y \cos^3 \theta = 4 \sin \theta \cos \theta$

$$\Rightarrow x \sin \theta \cdot \sin^2 \theta + y \cos^3 \theta = 4 \sin \theta \cos \theta$$

$$\Rightarrow y \cos \theta \cdot \sin^2 \theta + y \cos^3 \theta = 4 \sin \theta \cos \theta$$

$$y \cos \theta (\sin^2 \theta + \cos^2 \theta) = 4 \sin \theta \cos \theta$$

$$\Rightarrow y (\sin^2 \theta + \cos^2 \theta) = 4 \sin \theta$$

$$\boxed{y = 4 \sin \theta}$$

OR put $\theta = 45^\circ$

$$x \sin \theta = y \cos \theta$$

$$\boxed{x = y}$$

$$x \sin \theta - y \cos \theta = 0$$

$$x \sin \theta = y \cos \theta$$

put value of y

$$x \sin \theta = 4 \sin \theta \cdot \cos \theta$$

$$\boxed{x = 4 \cos \theta}$$

$$x^2 + y^2 = 16 \cos^2 \theta + 16 \sin^2 \theta$$

$$= 16 (\cos^2 \theta + \sin^2 \theta)$$

$$= 16 \text{ Ans.}$$

$$\frac{x}{2\sqrt{2}} + \frac{y}{2\sqrt{2}} = 4 \times \frac{1}{\sqrt{2}} \times \frac{1}{\sqrt{2}}$$

$$\frac{x+y}{\sqrt{2}} = 4$$

$$x+y = 4\sqrt{2}$$

$$2y = 4\sqrt{2}$$

$$y = 2\sqrt{2}$$

$$\therefore x = 2\sqrt{2}$$

$$x^2 + y^2 = (2\sqrt{2})^2 + (2\sqrt{2})^2 = 8 + 8 = 16$$

82) A, B, C are the angles of ΔABC w/c are in A.P

find $\frac{\sin A - \sin C}{\cos C - \cos A}$

- A) $\sin B$ B) $\tan B$
~~C) $\cot B$~~ D) $\tan\left(\frac{A+B}{2}\right)$

A	B	C
30	60	90

$$\frac{\sin 30 - \sin 90}{\cos 90 - \cos 30} = \frac{1 - \frac{1}{2}}{0 - \frac{\sqrt{3}}{2}}$$

$$= \frac{\frac{1}{2}}{\frac{\sqrt{3}}{2}} = \frac{1}{\sqrt{3}} \rightarrow \text{option c satisfies.}$$

83) $a = \operatorname{cosec} \theta - \sin \theta$

$b = \sec \theta - \cos \theta$

Put $\theta = 45^\circ$

$a = \sqrt{2} - \frac{1}{\sqrt{2}} = \frac{1}{\sqrt{2}}$

$b = \sqrt{2} - \frac{1}{\sqrt{2}} = \frac{1}{\sqrt{2}}$

$a^2 b^2 (a^2 + b^2 + 3) = ?$

$\frac{1}{2} \cdot \frac{1}{2} \left(\frac{1}{2} + \frac{1}{2} + 3 \right)$

$\frac{1}{4} \times 4$

$= 1$ Ans.

84) $\frac{\sin \theta - \cos \theta + 1}{\sin \theta + \cos \theta - 1} = ?$

~~A) $\frac{1 + \sin \theta}{\cos \theta}$~~

B) $\frac{1 + \cos \theta}{\sin \theta}$

C) $\frac{2}{\cos \theta}$

D) $2 \tan \theta$

$\theta = 0, 90^\circ$ पर ∞ आ रहा है।

$\theta = 45^\circ$ पर option A & B contradict करेंगे

so. put $\theta = 30^\circ$

$\frac{\frac{1}{2} - \frac{\sqrt{3}}{2} + 1}{\frac{1}{2} + \frac{\sqrt{3}}{2} - 1} = \frac{3 - \sqrt{3}}{2}$

$= \frac{\sqrt{3} - 1}{2}$

$= \frac{\sqrt{3}(\sqrt{3} - 1)}{\sqrt{3} - 1}$

$= \sqrt{3}$

option A satisfies.

$\frac{1 + \frac{1}{2}}{\frac{\sqrt{3}}{2}} = \frac{\frac{3}{2}}{\frac{\sqrt{3}}{2}} = \sqrt{3}$

~~$\frac{\sin \alpha}{\cos \alpha}$~~
 ~~$\frac{\sin \alpha}{\cos \alpha}$~~

(85) $a = \frac{\cos \alpha}{\cos \beta}$, $b = \frac{\sin \alpha}{\sin \beta}$

find value of $\sin^2 \beta$

$$a^2 = \frac{\cos^2 \alpha}{\cos^2 \beta} \quad \Bigg| \quad b^2 = \frac{\sin^2 \alpha}{\sin^2 \beta}$$

$$\cos^2 \alpha = a^2 \cos^2 \beta$$

$$+ \sin^2 \alpha = b^2 \sin^2 \beta$$

$$1 = a^2(1 - \sin^2 \beta) + b^2 \sin^2 \beta$$

$$1 = a^2 - a^2 \sin^2 \beta + b^2 \sin^2 \beta$$

$$1 - a^2 = -\sin^2 \beta (a^2 - b^2)$$

$$-\sin^2 \beta = \frac{a^2 - b^2}{1 - a^2}$$

$$\sin^2 \beta = \frac{a^2 - 1}{a^2 - b^2}$$

A) $\frac{a^2 + 1}{a^2 - b^2}$

B) $\frac{a^2 - 1}{a^2 - b^2}$

C) $\frac{a^2 - 1}{a^2 + b^2}$

D) $\frac{a^2 - b^2}{a^2 + b^2}$

GoCareer.in

Radians

⊕ π radian (π^c) = 180°

$$1^c = \frac{180^\circ}{\pi} = \frac{180 \times 7}{22 \times 11}$$

$$1^c = \frac{630^\circ}{11} = 57^\circ 16' 21''$$

$$\begin{array}{r} 11 \overline{)630^\circ} \quad 57 \\ \underline{55} \\ 80 \\ \underline{77} \\ 3^\circ \times 60 = 180' \end{array}$$

⊕ 86 $\frac{5\pi^c}{3}$ convert in degree.

$$\frac{5\pi}{3} \times \frac{180^\circ}{\pi} = 300^\circ$$

$$\begin{array}{r} 11 \overline{)180'} \quad 16 \\ \underline{11} \\ 70 \\ \underline{66} \\ 4' \times 60 = 240'' \\ \underline{22} \\ 20 \\ \underline{11} \\ 9'' \end{array}$$

⊕ 87 $\frac{4\pi^c}{15}$ convert in degree.

$$\frac{4\pi}{15} \times \frac{180^\circ}{\pi} = 48^\circ$$

⊕ 88 $(\frac{1}{6})^c$ convert in degree.

$$\frac{1}{6} \times \frac{180^\circ \times 7}{22 \times 11} = \frac{105^\circ}{11}$$

$$\begin{array}{r} 11 \overline{)105^\circ} \quad 9^\circ \\ \underline{99} \\ 6^\circ \times 60 = 360' \\ \underline{33} \\ 30 \\ \underline{22} \\ 8' \times 60 = 480'' \\ \underline{44} \\ 40'' \\ \underline{33} \\ 7'' \end{array} \Rightarrow 9^\circ 32' 43'' \underline{\underline{\text{Ans.}}}$$

⊕ 89 $11^\circ 15'$ convert in radian.

$$11^\circ \frac{15'}{60} = 11 \frac{1}{4}^\circ = \frac{45}{4}^\circ$$

$$180^\circ = \pi^c$$

$$1^\circ = \frac{\pi^c}{180}$$

$$\frac{45}{4}^\circ \times \frac{\pi}{180} = \frac{\pi^c}{16} \underline{\underline{\text{Ans}}}$$

90) $13^{\circ} 7' 30''$. convert in radian.

$$13^{\circ} 7' \frac{30}{60}$$

$$13^{\circ} 7\frac{1}{2}' \Rightarrow 13^{\circ} \frac{15}{2}' \Rightarrow 13^{\circ} \frac{15}{2 \times 60} \Rightarrow 13\frac{1}{8}^{\circ} = \frac{105}{8}^{\circ}$$

$$\Rightarrow \frac{105}{8} \times \frac{\pi}{180} \Rightarrow \frac{7\pi}{96}^{\circ}$$

91) $63^{\circ} 14' 51''$. convert in radian.

A) $\left(\frac{2811\pi}{8000}\right)^{\circ}$ B) $\left(\frac{3811\pi}{8000}\right)^{\circ}$

C) $\left(\frac{4811\pi}{8000}\right)^{\circ}$ D) $\left(\frac{5811\pi}{8000}\right)^{\circ}$

$$180^{\circ} = \pi^{\circ}$$

$$1^{\circ} = \frac{\pi}{180}$$

$$60^{\circ} = \frac{\pi}{180} \times 60 = \left(\frac{1}{3}\pi\right)^{\circ}$$

Take approx.
(near to 63°)

सारे option दूर-2 हैं
approx value से हो
जायगा।

option A is nearly $\left(\frac{1}{3}\right)$

OR $63^{\circ} 14' \frac{51}{60} \Rightarrow 63^{\circ} 14' \frac{17}{20}$

$$\Rightarrow 63^{\circ} \frac{297}{20 \times 60} \Rightarrow 63^{\circ} \frac{99}{400} \Rightarrow \frac{2811}{400} \times \frac{\pi}{180}$$

$$\Rightarrow \left(\frac{2811}{8000}\pi\right)^{\circ} \quad \underline{\underline{\text{Ans}}}$$

- 92) When a pendulum of length 50 cm oscillates produce an arc of 16 cm - find the angle formed in degree.

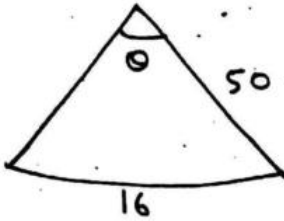

$$\theta^c = \frac{l}{r} = \frac{16}{50} = \frac{8}{25}^c$$

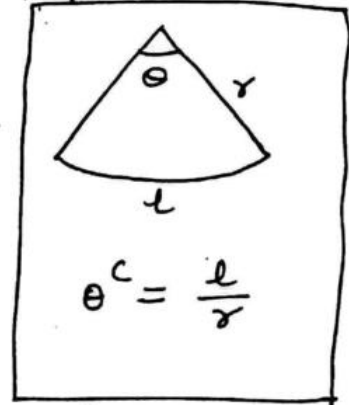

GoCareer.in

- 93) A wheel rotate 3.5 times in one second. In what time the wheel rotates 55^c of angle.

$$180^\circ = \pi^c$$

$$1 \text{ sec} \longrightarrow 2\pi \times \frac{7}{2} = 7\pi = 22^c$$

$$360^\circ = 2\pi^c$$

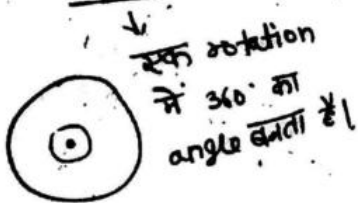

$$22^c \text{ ————— } 1 \text{ sec}$$

$$1^c \text{ ————— } \frac{1}{22} \text{ sec}$$

$$55^c \text{ ————— } \frac{1}{22} \times 55 \text{ sec} = 2.5 \text{ sec.}$$

- 94) two angles of a Δ are $\frac{1}{2}^c$ and $\frac{1}{3}^c$. find the 3rd angle in degree measure.

$$\frac{1}{2} + \frac{1}{3} = \frac{5}{6}^c$$

$$\frac{5}{6} \times \frac{30}{180 \times 7} = \frac{1050}{22} = 47 \frac{8}{11}$$

$$3^{\text{rd}} \text{ angle} = 180^\circ - 47\frac{8}{11} = 132\frac{3}{11} \quad \underline{\underline{\text{Ans.}}}$$

(95) Find the arc of a circle of radius 42 cm subtends an angle of 15° at the centre.

$$15^\circ = 15 \times \frac{\pi}{180} = \frac{\pi}{12} \text{ c} = \frac{22}{7 \times 12} = \frac{11}{42} \text{ c}$$

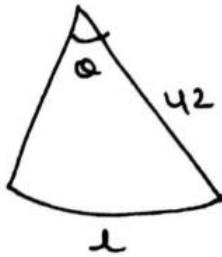

$$\frac{11}{42} \text{ c} = \frac{l}{42}$$

$$\boxed{l = 11 \text{ cm}} \quad \underline{\underline{\text{Ans.}}}$$

(96) Find the angle between the minute hand and hour hand of a clock when the time is 5:20 A.M.

$$\left| \frac{11}{2} \times 20 - 30 \times 5 \right|$$

$$\left| 110 - 150 \right|$$

$$40^\circ$$

$$\boxed{\text{Angle} = \left| \frac{11}{2} \text{ m} - 30 \text{ H} \right|}$$

GoCareer.in

#

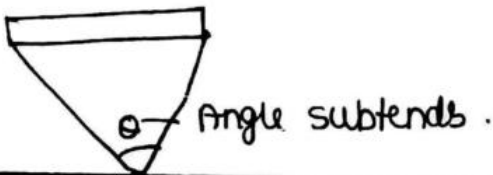
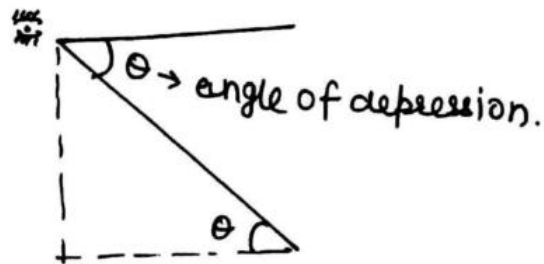
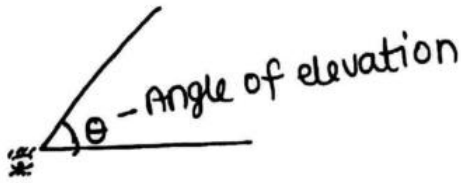
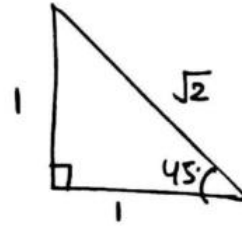
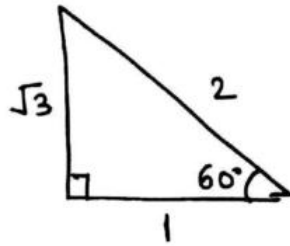
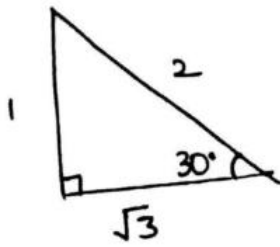

GoCareer.in

- ① The length of the shadow of a vertical pole 9 m high, when the sun's altitude is 30° , is

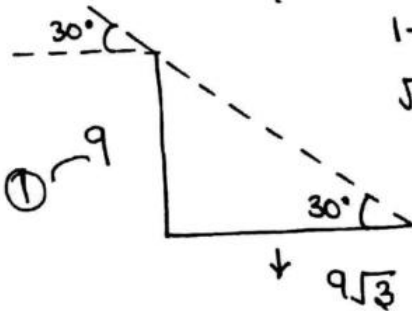

$$\begin{aligned} 1 &- 9 \\ \sqrt{3} &- 9\sqrt{3} \text{ Ans} \end{aligned}$$

- ② A guard observes an enemy boat, from an observation tower at a height of 180 m above sea level to be at an angle of depression of 60° . The distance of the boat from the foot of the tower is \rightarrow

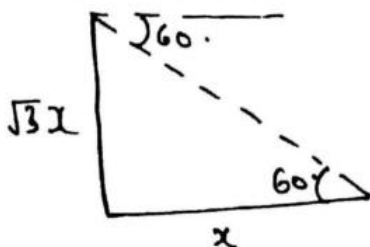

$$\sqrt{3}x = 180$$

$$\frac{\sqrt{3}}{\sqrt{3}} \times \frac{180}{\sqrt{3}} = x$$

$$x = 60\sqrt{3} \text{ Ans}$$

- ③ A telegraph post is bent at a point above the ground due to storm. Its top just meet the ground at a distance of $8\sqrt{3}$ m from its foot and makes an angle of 30° , then the height of the post is \rightarrow

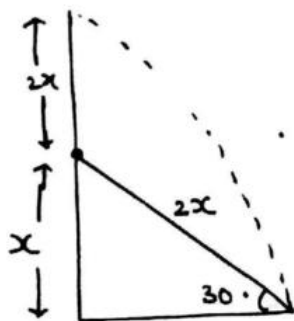

$$\sqrt{3}x = 8\sqrt{3}$$

$$x = 8$$

$$3x = 24 \quad \text{Ans}$$

$$8\sqrt{3} = \sqrt{3}x$$

GoCareer.in

- ④ The tops of two poles of height 24 m and 36 m are connected by a wire. If the wire makes an angle of 60° with the horizontal, then the length of the wire is -

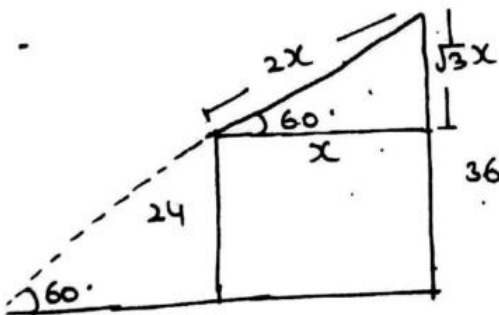

$$\sqrt{3}x = 12$$

$$x = \frac{12}{\sqrt{3}} \times \frac{\sqrt{3}}{\sqrt{3}}$$

$$= 4\sqrt{3}$$

$$2x = 8\sqrt{3} = \text{length of wire.}$$



- ⑤ The angle of elevation from the foot of the mountain to its top is 45° . After walking 42 km on the mountain on the inclination of 30° he finds that the angle of elevation to its top is 60° . Find the height of the mountain.

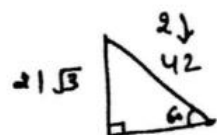
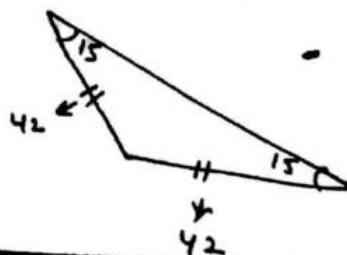
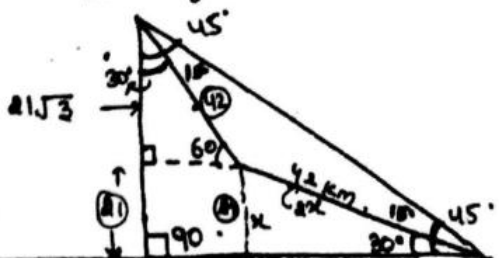

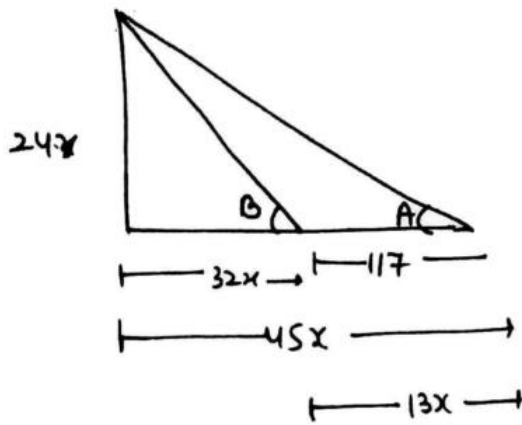

$$\tan A = \frac{8}{15} \times \frac{3}{3} = \frac{24x}{45x} - B$$

$$\tan B = \frac{3}{4} \times \frac{8}{8} = \frac{24x}{32x} - B$$

(दोनों Δ 's में Perpendicular same है)

$$13x = 117 \quad \boxed{x = 9}$$

Height of tower = $24 \times 9 = 216 \text{ m}$. Ans.

- ⑧ The angle of elevation of the top of an incomplete vertical tower at a horizontal distance of 100 m from its base is 45° . If the angle of elevation of the top of complete pillar at the same point is to be 60° . Then the height of the incomplete pillar is to be increased by -

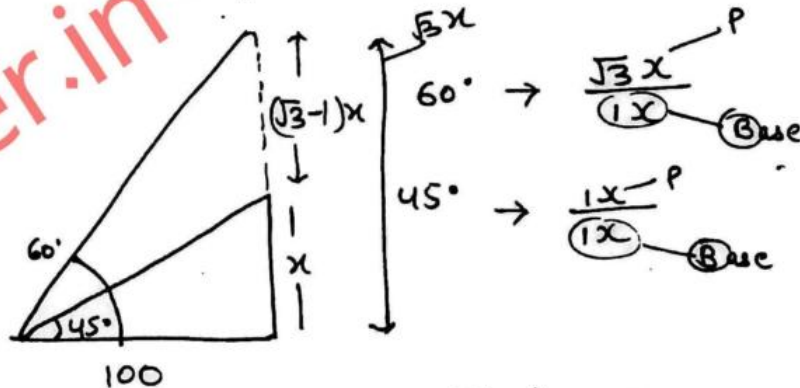

$100(\sqrt{3}-1)$ Ans.

- ⑨ An aeroplane when flying at a height of 3125 m from the ground passes vertically below another plane at an instant when the angles of elevation of the two planes from the same point on the ground are 30° & 60° respectively. The distance b/w two planes at that instant is -

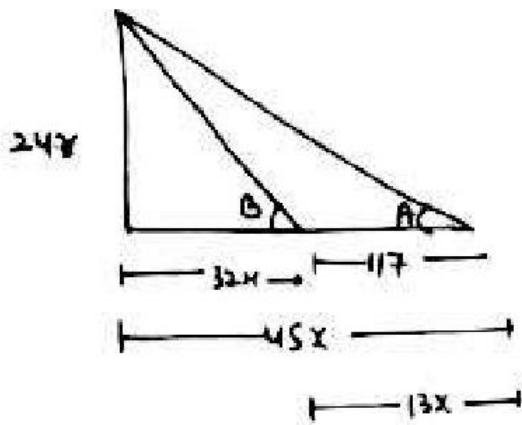

$$\tan A = \frac{8}{15} \times \frac{3}{3} = \frac{24x}{45x} \rightarrow B$$

$$\tan B = \frac{3}{4} \times \frac{8}{8} = \frac{24x}{32x} \rightarrow B$$

(दोनों Δ 's में Perpendicular same है)

$$13x = 117 \quad \boxed{x = 9}$$

Height of tower = $24 \times 9 = 216$ m. Ans.

GoCareer.in

- ⑧ The angle of elevation of the top of an incomplete vertical tower at a horizontal distance of 100 m from its base is 45° . If the angle of elevation of the top of complete pillar at the same point is to be 60° . Then the height of the incomplete pillar is to be increased by -

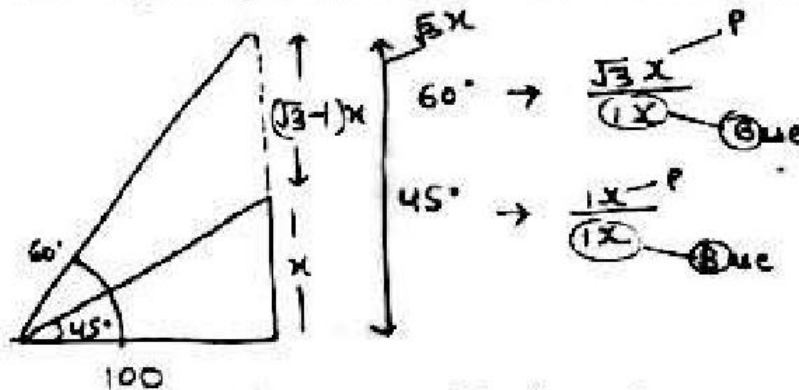

$100(\sqrt{3}-1)$ Ans.

- ⑨ An aeroplane when flying at a height of 3125 m from the ground passes vertically below another plane at an instant when the angles of elevation of the two planes from the same point on the ground are 30° & 60° respectively. The distance b/w two planes at that instant is -

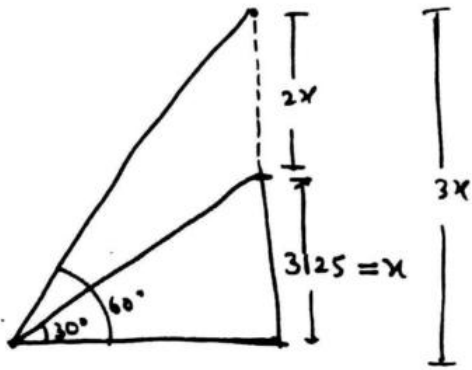

$$60^\circ \Rightarrow \frac{\sqrt{3}}{1} \times \frac{\sqrt{3}}{\sqrt{3}} = \frac{3x}{\sqrt{3}x}$$

$$30^\circ \Rightarrow \frac{1}{\sqrt{3}} = \frac{x}{\sqrt{3}x}$$

(Base same बनाने के लिए $\sqrt{3}$ से multiply किया है क्योंकि दोनों Δ 's के Base same है)

distance b/w them = $2x = 3125 \times 2 = 6250 \text{ m}$.

- ⑩ There are two vertical posts, one on each of a road, just opposite to each other. One post is 108 m high. From the top of this post, the angles of the depression of the top and foot of the other post are 30° & 60° respectively. The height of the other post, in metre is -

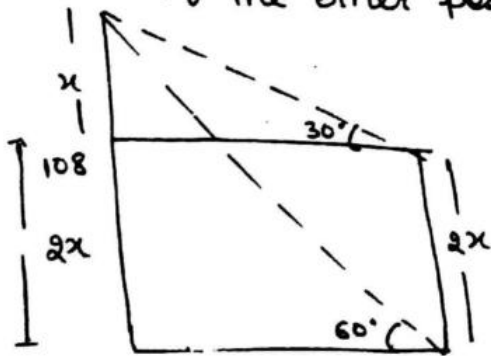

$$30^\circ = \frac{1}{\sqrt{3}} \times x = \frac{x}{\sqrt{3}x}$$

$$60^\circ = \frac{\sqrt{3}}{1} \times \sqrt{3} = \frac{3x}{\sqrt{3}x}$$

(दोनों Δ का Base same है)

$$3x = 108$$

$$x = 36$$

$$2x = 72 \text{ m } \underline{\text{Ans}}$$

GoCareer.in

- ⑪ The shadow of a tower standing on a level plane is found to be 50 m longer when the sun's elevation is 30° than when it is 60° . Find the height of tower?

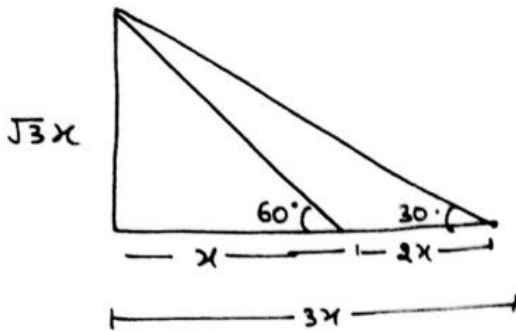

$$60^\circ \Rightarrow \frac{\sqrt{3}}{1} = \frac{\sqrt{3}x}{x}$$

$$30^\circ \Rightarrow \frac{1}{\sqrt{3}} = \frac{x\sqrt{3}}{3x}$$

$$2x = 50$$

$$x = 25$$

$$\text{Height} = 25\sqrt{3} \text{ Ans.}$$

- (12) The angles of elevation of the top of a tower from two points A and B lying on the horizontal through the foot of tower are respectively 15° and 30° . If A and B are on the same side of the tower and $AB = 48$ m, then the height of the tower is -:

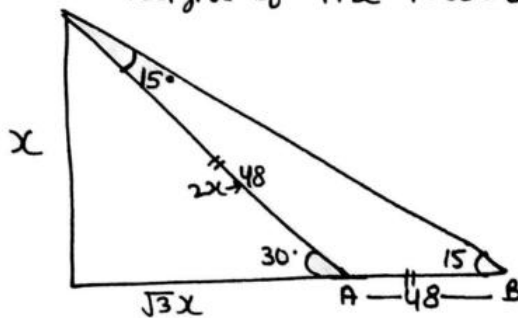

$$2x = 48$$

$$x = 24$$

Ans.

- (13) The angle of elevation of the top of a tower from the points P & Q at a distance A cm & B cm respectively from the base of the tower, and in the same straight line with angles are complementary. Find height of tower..

- (14) The angle of elevation of the top of a building from the top and bottom of a tree are x and y . If the height of the tree is h metre. Find the height of the building ?

- ⑮ A flagstaff 5 m high stands on top of a building 35 m high; an observer at a height of 30 m finds the flagstaff & the building subtends equal angle. find the distance of the observer from the flagstaff.

Solutions

⑬

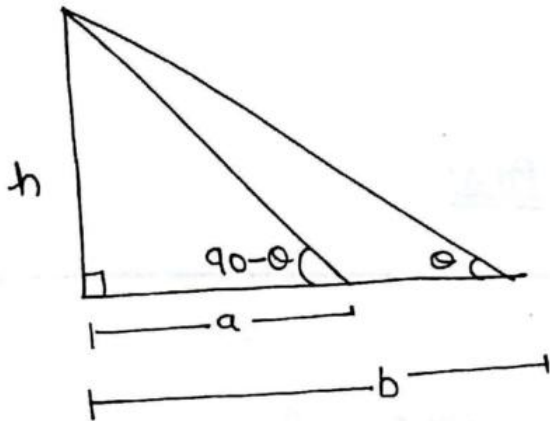

$$\frac{H}{a} = \tan(90 - \theta) = \cot \theta$$

$$H = a \cot \theta \quad \text{--- (i)}$$

$$\frac{H}{b} = \tan \theta$$

$$H = b \tan \theta \quad \text{--- (ii)}$$

Multiply (i) and (ii)

$$H^2 = ab \cot \theta \cdot \tan \theta$$

$$H^2 = ab \quad \therefore \boxed{H = \sqrt{ab}} \quad \underline{\text{Ans.}}$$

GoCareer.in

⑭

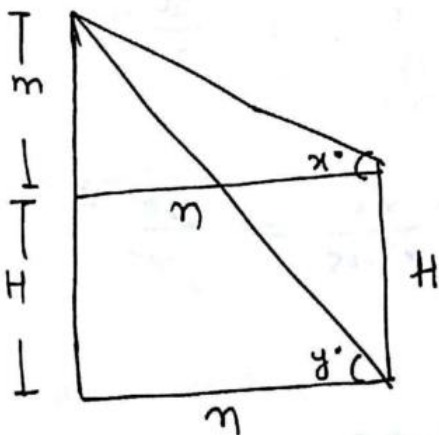

$$\frac{n}{m} = \cot x \quad \left(\frac{B}{P} = \cot \right)$$

$$n = m \cot x \quad \text{--- (i)}$$

$$\frac{n}{H+m} = \cot y$$

$$n = (H+m) \cot y \quad \text{--- (ii)}$$

$$m \cot x = (H+m) \cot y$$

$$m \cot x = H \cot y + m \cot y$$

$$m \cot x - m \cot y = H \cot y$$

$$m(\cot x - \cot y) = H \cot y$$

$$m = \frac{H \cot y}{\cot x - \cot y}$$

$$\text{Height of Building} = m + H$$

$$\frac{H \cot y}{\cot x - \cot y} + \frac{H}{1}$$

$$\frac{H \cot x}{\cot x - \cot y}$$

Ans.

15

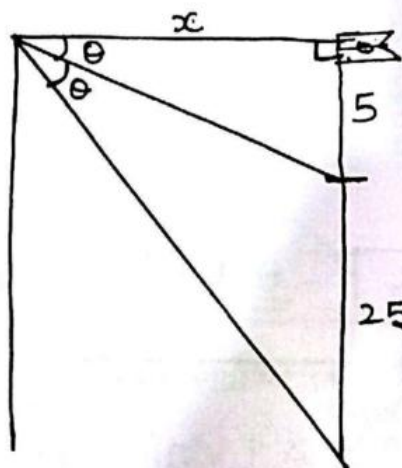

$$\tan \theta = \frac{5}{x}$$

$$\tan 2\theta = \frac{30}{x}$$

$$\frac{2 \tan \theta}{1 - \tan^2 \theta} = \frac{30}{x}$$

$$\frac{2 \times \frac{5}{x}}{1 - \frac{25}{x^2}} = \frac{30}{x}$$

$$\Rightarrow \frac{\frac{10}{x}}{\frac{x^2 - 25}{x^2}} = \frac{30}{x} \Rightarrow \frac{10}{x} \times \frac{x^2}{x^2 - 25} = \frac{30}{x}$$

$$\Rightarrow \frac{x^2}{x^2 - 25} = 3 \Rightarrow x^2 = 3x^2 - 75$$

$$\Rightarrow x^2 = \frac{75}{2}$$

$$\boxed{x = \sqrt{\frac{75}{2}}} \text{ Ans}$$

- ✓ (6) A round balloon of radius r subtends an angle α at the eye of an observer. While the angle of elevation of its centre is β . find the height of the centre of balloon from the ground?

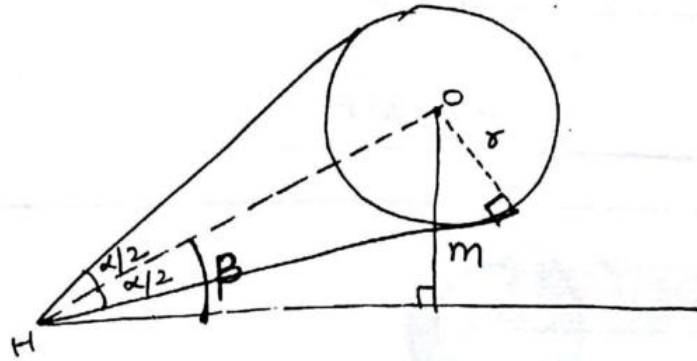

$$\frac{OH}{r} = \operatorname{cosec} \frac{\alpha}{2}$$

$$\frac{m}{OH} = \sin \beta$$

$$m = OH \sin \beta$$

$$m = r \operatorname{cosec} \frac{\alpha}{2} \sin \beta$$

Ans

- ✓ (7) The angle of elevation of a cloud from height H above the level of water in a lake is α . and the angle of the depression of its image in the lake is β . find the height of the cloud above the surface of the lake.

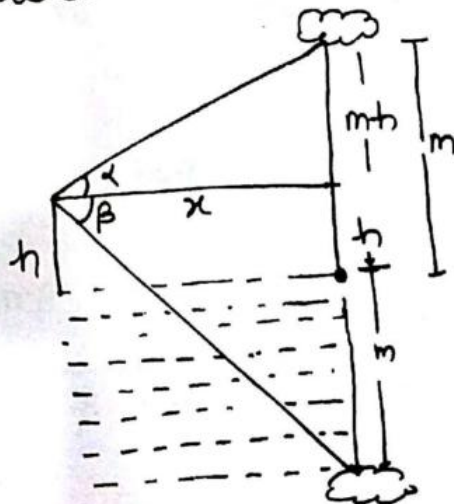

$$\frac{x}{m-h} = \cot \alpha$$

$$x = (m-h) \cot \alpha \quad \text{--- (i)}$$

$$\frac{x}{m+h} = \cot \beta$$

$$x = (m+h) \cot \beta \quad \text{--- (ii)}$$

Equate (i) and (ii)

$$(m-h)\cot\alpha = (m+h)\cot\beta$$

$$m\cot\alpha - h\cot\alpha = m\cot\beta + h\cot\beta$$

$$m(\cot\alpha - \cot\beta) = h(\cot\alpha + \cot\beta)$$

$$m = \frac{h(\cot\alpha + \cot\beta)}{\cot\alpha - \cot\beta}$$



GoCareer.in

DI

A

Total students = 8550.

Total passed = 5700.

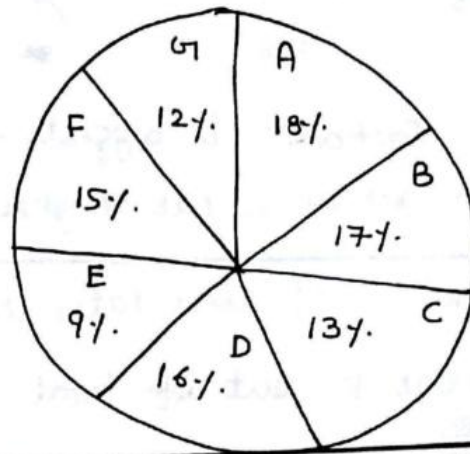
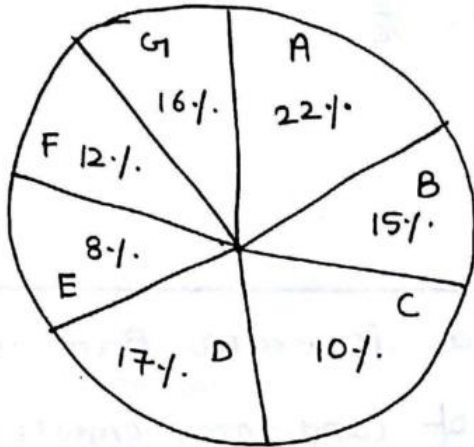

1] What is the ratio of candidate of passed to the candidate appeared in school A.

- A) 6 : 11 B) 11 : 6 C) 6 : 7 D) 7 : 6

$$\frac{8550}{5700} = \frac{3}{2}$$

— Appeared
— passed

$$\frac{\text{Passed (A)}}{\text{Appeared (A)}} = \frac{\frac{6}{18 \times 2}}{\frac{22 \times 3}{11}} = 6 : 11.$$



2] What % of candidate passed to the candidates enrolled for the school B+C together.

- A) 60% B) 72% C) 76% D) 80%

$$\frac{2 \times 30}{3 \times 25} \times 100 = 80\%$$

3] W/c school has the highest % of candidates passed to the candidates enrolled?

- A) B B) C C) E D) F

B	C	E	F
$\frac{34}{45}$	$\frac{26}{30}$	$\frac{18}{24}$	$\frac{30}{36}$
$\frac{34}{45}$	$\frac{13}{15}$	$\frac{3}{4}$	$\frac{5}{6}$
510	585	90	

fraction c is biggest .

so, school c has highest %.

4] What % of candidates passed in exam from the school E out of total no. of candidates enrolled from the same school ?

$$\frac{3 \cancel{9} \times 2}{4 \cancel{9} \times 3} \times 100 = 75\%$$

5] The total no. of candidates passed from school A+D exceed the no. of candidate enrolled from the school E+C together.

- A) 299 B) 399 C) 379
D) 439.

$$\underbrace{5700 \times \frac{34}{100}}_{\text{A+D passed}} - \underbrace{8550 \times \frac{18}{100}}_{\text{E+C enrolled}}$$

$$1938 - 1539 = 399$$

OR 8550 : 5700 के ratio में 19 एक factor था , so, Ans में 19 factor रहेगा . | only option B satisfies .

② The pie chart given here shows expenditure by a family on various items and their saving which amounts to Rs. 8000. in a month.



www.Gocareer.in

① How much expenditure is incurred on education.

$$\text{Savings} = 60^\circ = 8000$$

$$1^\circ = \frac{8000}{60} = \frac{400}{3}$$

$$\text{Education} = \frac{400}{3} \times 30^\circ = 4000 \text{ Rs.}$$



② The ratio of exp. on food to the saving is ?

$$\frac{120^\circ}{2} : \frac{60^\circ}{1}$$

③ What is the total exp. of the family for the month?

$$\text{Exp} = 360 - \underset{\substack{\downarrow \\ \text{saving}}}{60} = 300^\circ = \frac{100}{300} \times \frac{400}{3} = 40,000 \text{ Rs.}$$

④ How much more amount spent on food than on housing ?

$$120^\circ - 105^\circ = 15^\circ \times \frac{400}{3} = 2000 \text{ Rs.}$$

C



1] The central angle for the paper cost is what?

$$100\% \rightarrow 360^\circ$$

$$1\% \rightarrow 3.6^\circ$$

$$\text{paper cost} = 10\% = 36^\circ$$

2] If printing cost is 17,500 then find the royalty?

$$35\% \rightarrow 17500$$

$$1\% \rightarrow \frac{17500}{35} = 500$$

$$\text{Royalty} = 15\% = 15 \times 500 = 7500 \text{ Rs.}$$

3] If the mis. expenses are Rs 6000, how much more are binding charges than royalty.

$$4\% \rightarrow 6000$$

$$1\% \rightarrow 1500$$

$$18\% - 15\% = 3\%$$

$$\Rightarrow 3 \times 1500 = 4500 \text{ Rs.}$$



4] The central angle corresponding to the sector of printing cost is more than the advertisement by what?

$$35\% - 18\% = 17\% = 17 \times 3.6 = 61.2^\circ \quad \underline{\text{Ans}}$$

5] The paper cost is approx. what % of printing cost?

$$\frac{20}{35} \times 100 = 28 \frac{4}{7}\%$$

D

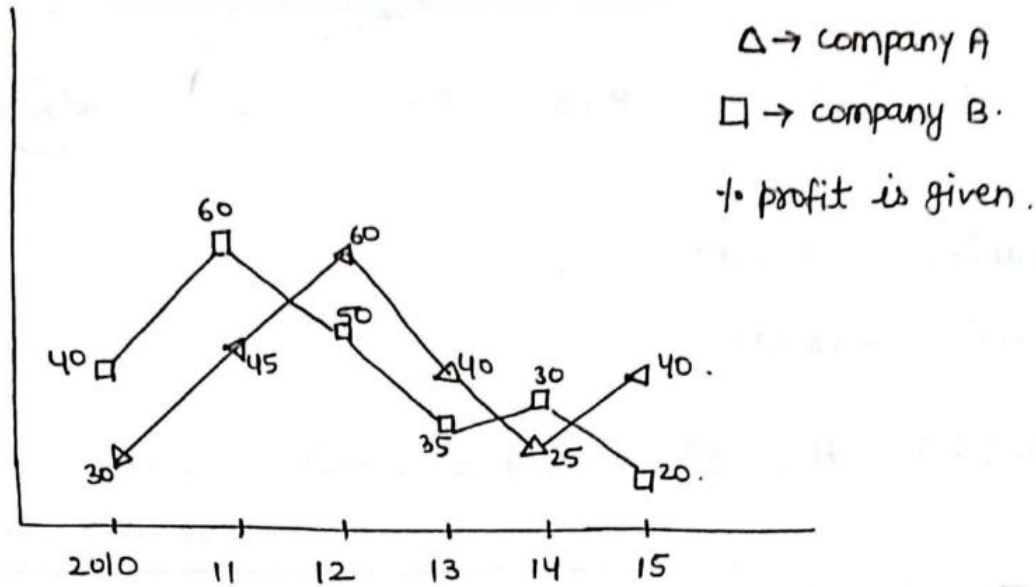

1. What is the % increase in the % profit of company A from the year 2011 to 2012.

$$\frac{15}{45} \times 100 = 33.33\%$$

2. If the income of company A and B are equal in the year 2012, then ratio of exp. of A to B is →

$A = 60\% = \frac{3}{5}$	$\frac{P}{Exp}$	A	5×3	3×3	8×3
$B = 50\% = \frac{1}{2}$		B	2×8	1×8	3×8

$$Exp\left(\frac{A}{B}\right) = 15 : 16.$$

3. If the income of company A in 2014 and the exp of company B in 2015 are equal and is 90 lakh each. What is the diff b/w income of B in 2015 and exp of A in 2014.

$$A_{14} = 25\% = \frac{1}{4}$$

$$B_{15} = 20\% = \frac{1}{5}$$

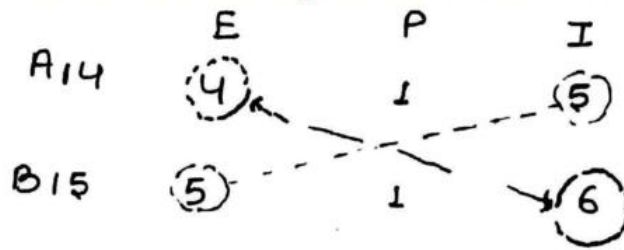

5 unit — 90 lakh

1 unit — 18 lakh.

$$B_{15}(I) - A_{14}(E) \Rightarrow 6 - 4 = 2 \text{ unit} = 2 \times 18 = 36 \text{ lakh } \underline{\underline{\text{Ans}}}$$

4] The exp. of company B in 2011 is what % of its income in that year.

$$60\% = \frac{3}{5} \begin{matrix} \text{--- P} \\ \text{--- E} \end{matrix} \quad I = 8.$$

$$\frac{5}{8} \times 100 = 62\frac{1}{2}\% \quad \underline{\underline{\text{Ans}}}$$

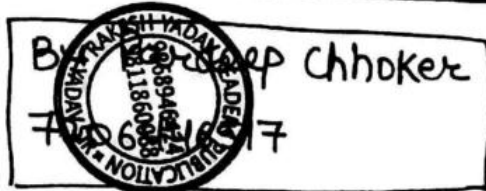

Download All Subject Free PDF

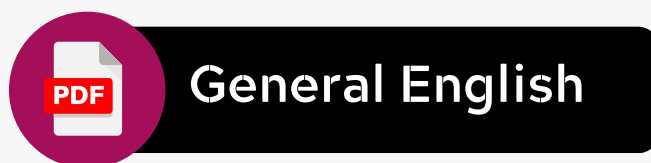
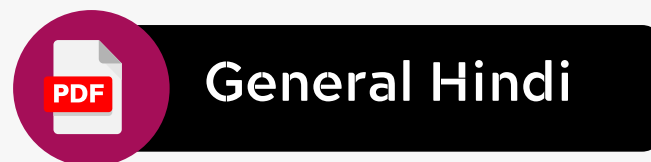
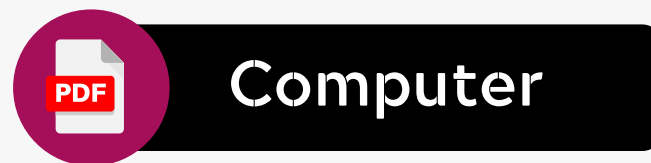
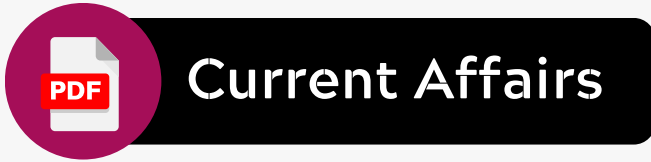
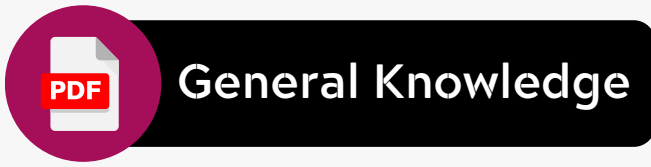



Join Our Best Course

GK Trick By
Nitin Gupta

Current Affairs

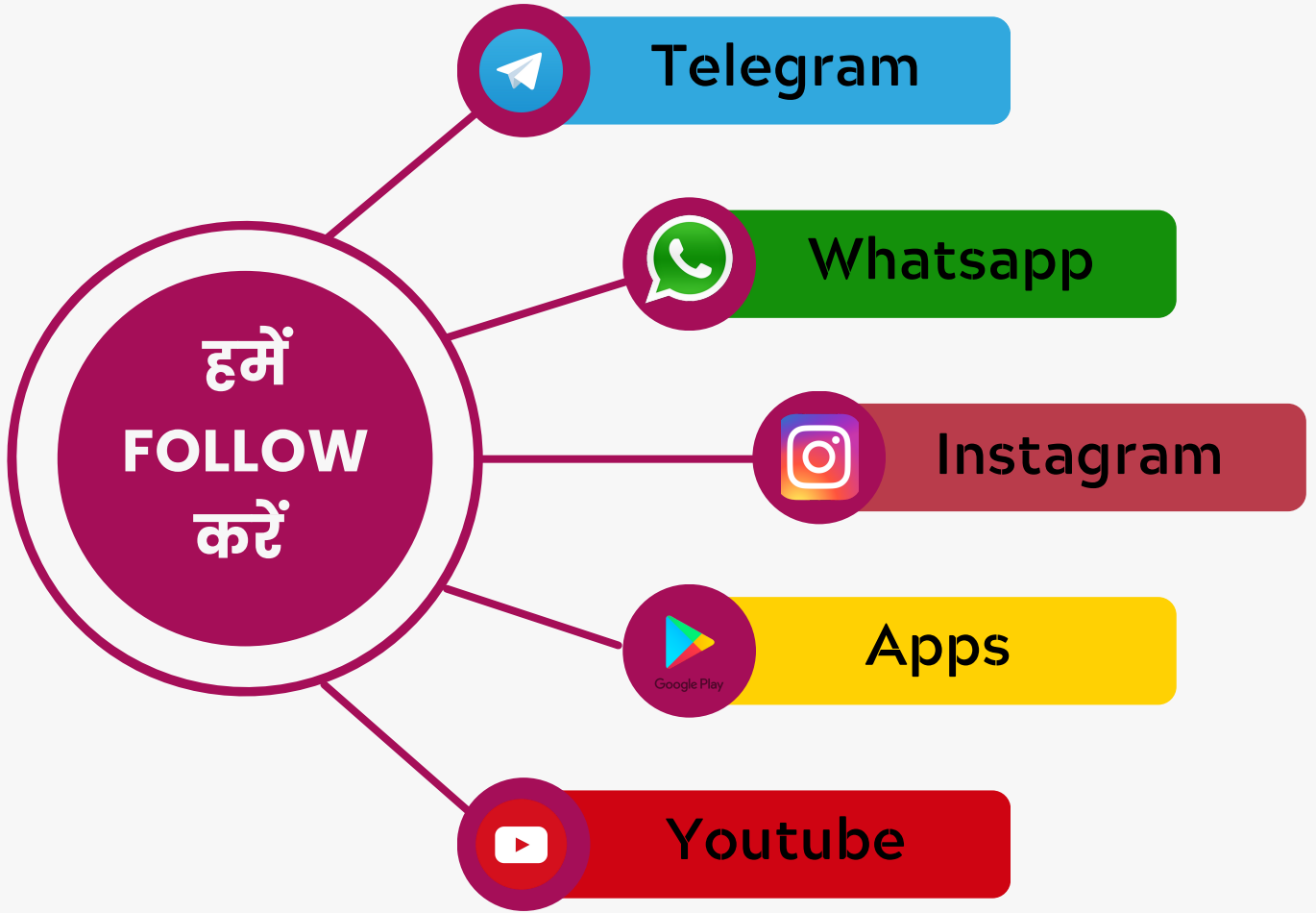
Daily Current Affairs PDF, Best Test Series, Best GK PDF के लिए हमें Follow करें



 GK Trick By Nitin Gupta
The Ultimate Key to Success.

Welcome To

GK TRICK BY NITIN GUPTA APP

यहाँ पर आपको मिलेगा

- ✓ Best PDF Notes For All Exams
- ✓ Best Test Series For All Exams
- ✓ Daily Current Affairs PDF
- ✓ सभी Course बहुत ही कम Price पर
- ✓ सभी Test Detail Discription के साथ व Analysis करने को सुविधा

